

Sri Jain Kala Sahitya Samsodhak Series No. 1

Comparative and Critical Study of Mantrasastra

(With Special Treatment of Jain Mantravada)

Being the
Introduction to Sri Bhairava Padmavati Kalpa

By

MOHANLAL BHAGWANDAS JHAVERY

B. A. (Hons.), LL. B., Solicitor

Author of Historical Facts about Jainism

Author of Introduction to and Editor of Nirvanakalika and

Author of Introduction to Gathasahasri etc.

With text by

Prof. K. V. Abhyankar M. A.

and

Eight full-colour and thirty mono-colour plates



Published by

SARABHAI MANILAL NAWAB · AHMEDABAD

Price 45 Rupees



Sri Jain Kala Sahitya Samsodhak Series No. 1

Comparative and Critical Study of Mantrasastra

(With Special Treatment of Jain Mantravada)

Being the
Introduction to Sri Bhairava Padmavati Kalpa

By

MOHANLAL BHAGWANDAS JHAVERY

B. A. (Hons.), LL. B., Solicitor

Author of Historical Facts about Jainism

Author of Introduction to and Editor of Nirvanakalika and

Author of Introduction to Gathasahasri etc.

With text by

Prof. K. V. Abhyankar M. A.

and

Eight full-colour and thirty mono-colour plates



Published by

SARABHAI MANILAL NAWAB · AHMEDABAD

Price 45 Rupees

All rights reserved by the Publisher

**This Edition is limited to four hundred copies only
out of which this is No.**

V. S. 2000 § 1944 A. D.

**Printed by B. Rawat at Kumar Printery, 1454 Raipur Ahmedabad
Published by Sarabhai Manilal Nawab, Director Shree Jain Kala Sahitya Samsodhaka Karya'
Nagajibhuder Pole, Ahmedabad**

Dedicated
to
Seth Maneklal Chunilal Shah I. P.

CONTENTS

	Pages
1. Purpose and Scope	1-2
2. Magic and Magical Symbolism	2-4
3. Thought-force	4-6
4. New Thought, New Psychology	6-16
Imagination 7 Desire 10 Triple Key of Success 12 confident Expectation 13 Will 14.	
5. Mentative Energy and Magic	16-18
6. Telepathy and Clairvoyance	18-23
Rudolf Tichner 19 Subconscious and Super-conscious 21.	
7. Contemplation Colours and Emotions	23-29
Human Aura-Significance 24 Scientific Recognition 24 Com- position 25 Prāṇa-Aura 25 Methods of Developing 25 Key to the Astral Colours 26 Colours and Emotions 26 Ātmarakṣā and Protective Aura 28.	
8. Mantra—How it acts	29-39
Views of Western Writer's 29 Tāntrik View 31 Tāntrik Theory 32 Writer's View 35.	
9. Kundalinī Shakti	39-46
Yoga 39 Kundalinī Shabda Brahman 41 Nāda-Bindu-Kalā 41 Six Chakras 42 Shatchakra Vedha 43 Samādhi 45 Mukti 45.	
10. Tantras	46-63
Western Writer's ignorance 46 Necessity for Practical Method in Religion 47 Ritual and its Utility 47 Attitude of English- educated Indians 48 Impartial Criticism, Contents and Chara- cteristics of Tantras 49 Schools and Divisions 50 Common Characteristics 51 Āmnāyas-Sampradāyas 52 Krāntas-Matas- Tāntrik Ācharas 53 Antiquity Value of Tantras 55 Objections 56 Panchatattva 57 Jain Bauddha Influence 60 No Pancha- tattva Worship' in Jain Tantra 60 Mantras and Vaiṅk literature 61 Tantras and Vedas 61.	

11. Tāntrik Sādhanā 63-87 .
 Aim and Means 63 Guru and Dīkṣā 65 Common Elements
 65 Psychological Principles 66 Nīla Sādhanā-Shava Sādhanā
 69 Yantra Pūja 70 Mandala 71 Mudrā 72 Three Meanings of
 Mudrā 72 Preliminary Rites 73 Objects of different Rites 74
 Five kinds of worship 74 Places-Time-Directions for Worship
 75 Seats and Postures 76 Rosaries 76 Purification of the
 Five 77 Bhūtashuddhi 78 Nyāsa 79 Jīva-Mātrikā-Vidyā-Rishi
 Nyāsa 80 Shaḍaṅga-Kara-Shodhā Nyāsa 81 Dhyāna 82 Japa
 83 Homa, Tarpaṇa, Brāhmaṇa Bhojana etc. 81 Siddhi 85
 Upachāra 85 Mahāpūjā 87.
12. Mantrayāna Vajrayāna and Tāntrism amongst the
 Buddhists 88-112
 Hindu Māntric system 95 Purāṇas 100 Nāgārjuna's Kakṣa-
 puta 103 Manjuśri-Mūlakalpa 104 Conclusion 106 Examina-
 tion of Dr. B. Bhattācharya's views 108 Earlier and Later
 Tāntrism 111.
13. Mysticism of Darvishes. 113-146
 The Darvish orders 118 Darvish Orders in India 124 Religious
 Practices 130 The Auliā or saints 133 Miraculous Practices
 134 Magic 135 Charms and Talismans 136 Diviners 137 Asmā-
 Ul-'Husna 138 The Naqshbandī Zikr 140 Spiritual Powers
 and their Dovelopment 142 Murāqabah, Insilā and Tawajjuh
 143 Spiritual Powers 144.
14. Jain Mantravāda and Caityavāsis 147-211
 Śrī Pārśvanātha and Pūrva Literature 147 Uvasaggaharam
 150 Miraculous Works 151 Pārśvāpatyas and Nimitta 151
 Naimittikas-Sārūpikas-Siddhaputras 152 Lax Practices 154
 Prabhṛtas 155 Aṅgavidyā 157 Panca Parameṣṭi Mantra 157
 Nirvāṇakalikā 158 Vardhamāna Vidyā 159 Tīrthānujñā and
 Vāsakṣepa 161 Sūrimantra 161 Pūrvaseva and Uttarasevā
 165 Unity of Panca Parameṣṭi Mantra, Vardhamāna Vidya
 and Sūrimantra 166 Siddhacakra 167 Worship of Mantra-Deity
 not incompatible with Karma Philosophy 169 Hādi Mata 173
 Earlier Mantrasiddhas 173 Vidyādhara 175 Vidyādhara Peḍhā-
 laka and Vidyā-Cakravarti Maheśvara 176 Ratnaprabhasūri

176 Vidyādhara Kula etc. 177 Caityavāsīs 177 Ārya Mahāgiri and Ārya Suhasti 179 Jain Emperor Samprati 180 Period after Samprati 184 Vajraswāmi 185 Kālakacārya 189 Ārya-khaputācārya 191 Mantrasiddhas-Ārya Rohaṇa 192 Nāgārjuna 193 Yaśobhadsasūri 194 Mānaśvasūri 199 Temple-Building Activity in the 6th and 7th centuries 200 Mānatuṅgasūri 202 Haribhadrasūri 203 Bappabhattsūri 205 Siddharṣi 206 Sūrācārya 207 Jineśvarasūri 208.

15. Māntrikas Subsequent to 1080 Vikrama Era . . . 212-254

Abhayadevasūri 212 Vīrācārya 213 Jinadattasūri 214 Vādidevasūri 216 Hemacandrācārya, Malayagiri and Devacandrasūri 218 Pārśvadevagaṇi alias Candrasūri 221 Sāgaracandrasūri 221 Amaracandrasūri 222 Bālacandrasūri 224 Dharmaghoṣasūri 225 Devabhadragaṇi 227 Pūrṇa Kalaśagaṇi 228 Jinaprabhasūri 229 Jina Kuśalasūri 236 Bhuvanatuṅgasūri 238 Merutuṅgasūri 238 Munisundarasūri 239 Śubhasundaragaṇi 241 Hemavimalasūri 241 Jinacandrasūri 242 Upādhyāya Śānticaṇḍra 243 Upādhyāya Yasovijaya 244 Pandit Vīravijaya 249 Muni Mohanlālji 251.

16. Antiquity of Jain Mantras and Māntic Literature . . . 255-294

Jain Stūpa and other Antiquities of Mathurā 255 Popular Jain Deities 257 Vidyādevīs 258 Āmbikā and other Māntic Deities 258 Vidyādevīs and origin of Vidyādharas 260 Sūtra-kṛtāṅga Vidyā 262 Vasudevahiṇḍi Vidyās 263 Jwālāmālīnī and Digambara Jain Māntrikas 264 Paumacarīyam, Padmaritra Triṣasthiśalākāpuruṣacaritra and Vidyās 265 Śrī, Hrī, Dhṛti, Kīrti, Buddhi and Lakṣmī 267 Jain Narrative Literature Vidyās and Mantras 267 Auspicious and Protective Māntic Rites 268 Reference to Vidyās and Mantras from Scriptures 271 Ācārāṅga and Uttarādhyayana 271 Thaṇāṅga 271 Samavāyāṅga Rāyapaseṇī and Jambudvīpaprajñaptī 272 Bhagavatisūtra, Jnātādharma-Katkāṅga, Antakṛddasāṅga, Vipāka and Uvavāi 273 Praśnavyākaraṇa 274 Vipākasūtra 274 Upāṅgas 275 Dasavaikālika and Prabhāvakas 275 Prabhāvakas 276 Āvaśyakasūtra 277 Piṇḍaniryukti 278 Vyavahārasūtra 280 Niśīthasūtra 282 Mahāniśītha 284 Bṛhatkalpa 284 Ghaṇṭika Yakṣa and Ghantākaraṇa 285 Payannas 287 Popu-

larity of Śrī Pārśvanāthas Worship 287	Antiquity of Panca	
Parameṣṭi Mantra 289	Mantra-Kalpas, Mantras and Vidyās	
290	Conclusion 293	
17.	Contents (of Śrī Bhairava Padmāvati Kalpa) . . .	295–299
18.	The Author and the Commentator . . .	300–306
	Vidyānuśāsana 301.	
19.	Appendices (of Śrī Bhairava Padmāvati Kalpa) . . .	307–352
	Appendix 1. Adbhuta Padmāvati Kalpa 307	
	Appendix 2. Padmāvati Pūjana 309	
	Appendix 3. Rakta Padmāvati Kalpa	
	etc. 309	
	Appendix 4. Śrī Pārśvanāthastotra etc. 310	
	Appendix 5. Padmāvatiṣṭotra etc. 311	
	Appendix 6, 313, Appendix 7,	
	Appendix 8, 314	
	Appendix 9, Appendix 10, 315	
	Sarasvatī 316	
	Appendix 11, 318	
	Appendix 12, 319	
	Appendix 13, 320	
	Appendix 14, Appendix 15, Śrī Ambikā 322	
	Appendix 16, 326	
	Appendix 17 to 19, 327	
	Appendix 20, 328	
	Appendix 21, 329	
	Cakreśvari 330	
	Appendices 22 and 23, 331	
	Appendix 24, 332	
	Appendix 25, 335	
	Appendix 26, 336	
	Appendix 27, 338	
	Appendix 28, 338	
	Appendix 29, 338	
	Appendix 30, 339	
	Appendix 31, 351.	
20.	Parsis and Mantras . . .	353–360
	The Amesh-spentas or Holy Immortals 353	
	Yazatas 354	
	Cult of Mithra 356	
	Fravashis 356	
	Principal doctrines 357	
	Vedic connection 357	
	Mantras 358	
	Ahuna Vairya 359	
	Ashem	
	Vohu 359	
	Yenghe Hātām 359.	
21.	Conclusion.	360–361
APPENDIX A.		362–365
	Mānadevasūrikṛta-Sūrimantrastotra 362	
	Yoniprābhṛta	
	Mantras 363	
	Māṇibhadramantra-Gaṇadharavalayamantra	
	-Vidyās of Aṅga-Vidyā: 364	
	Aṅgavidyā-Bhūtikarma	
	vidyā 364	
	Siddhavidyā-Paḍirūvavidyā 364	
	Padihāra	
	alias Svaravidyā 365	
	Mahānimittavidyā 365.	

CONTENTS OF TEXT

Srī Bhairava Padmāvati Kalpa	by Malliṣeṇasūri	1-74
Chapter 1	Māntrilakṣaṇādhikāra	1-4
„ 2	Sakalikaraṇa Paricheda	5-8
„ 3	Devycaranādhikāra	9-18
„ 4	Dvādaśrañjikāmaṅtroddhārādhikāra	19-23
„ 5	Krodhādistaṃbhanayantrādhikāra	24-29
„ 6	Aṅganākaraṇādhikāra	30-35
„ 7	Vaśikaraṇayantrādhikāra	36-44
„ 8	Nimittādhikāra	45-52
„ 9	Vaśikaraṇatantrādhikāra	53-61
„ 10	Gārudatantrādhikāra	62-74
Appendices		1-136
1	Adbhuta Padmāvati Kalpa	1-14
2	Śrī Padmāvati-pujana	15-17
3	Rakta Padmāvati Kalpa etc.	18-20
4	Śrī Padmāvativratodyāpana	21-25
5	Śrī Padmāvati-stotra etc	26-38
6	Śrī Padmāvati-stuti	39-42
7	Padmāvati-mantrāmnāyavidhi	43-46
8	Padmāvatisahasranāmastotra	47-56
9	Śrī Padmāvati-stotra	57
10	Śrī Padmāvaticatuṣpadikā	58-60
11	Sarasvati Mantrakalpa	61-68
12	Śrī Sarasvati Kalpa	69-78
13	Paṭhisiddha Sārasvatastava	79-80
14	Śrī Śāradā Stavana	81
15	Devī Stotra	82-87
16	Śrī Ambikāṣṭaka	88-89
17	Ambikāstuti	90
18	Ambikātaṭankah	91
19	„	92-94
20	Śrī Ambikā Stavana	95
21	Śrī Ambikādevī Stuti	96

22	Śrī Cakreśvari Stotra	97-98
23	Śrī Cakreśvari Aṣṭaka	99-100
24	Śrī Catuṣṣaṣṭiyoginī Stotra	101
25	Jwālāmālīnī Mantrastotra	102-105
26	Śrī Garbha Stotra	106-108
27	Śrī Padmāvati Stotra	109
28	Śrī Padmāvati Kavaca	110-111
29	Surividyāstotra	112-113
30	Anubhavasiddhamantradvātriṃśikā	114-128
31	Śrī Laghuśāntistava	129-136

LIST OF PLATES

Goddess Padmāvati	Frontispiece
(1) Totalā, (2) Tvaritā, (3) Nityā, (4) Tripurā, (5) Kamasādhinī, (6) Tripurabhairavi (7) Goddess Padmāvati with 24 hands	Facing page 1
(8) Yakṣa Pārṣva, (9) Goddess Padmāvati	„ page 17
(10) Goddess Shrutadevī (Sarasvatī)	„ Appen. 11
(11) „ Ambikā	„ „ 16
(12) „ Cakreśvari	„ „ 22
(13) „ Sarvastra-Mahajwala alias (Jwālāmālīnī)	„ page 105
(14) Goddess Shanti	„ Appen. 31
(15) Yaksh Brahmashanti	„ page 136

LIST OF YANTRAS

Fig. 1 to 44	Yantra of Śrī Bhairava Padmāvati Kalpa
„ 45	Padmāvatiṭṭujana Yantra
„ 46 to 57	Tantrik Mudras

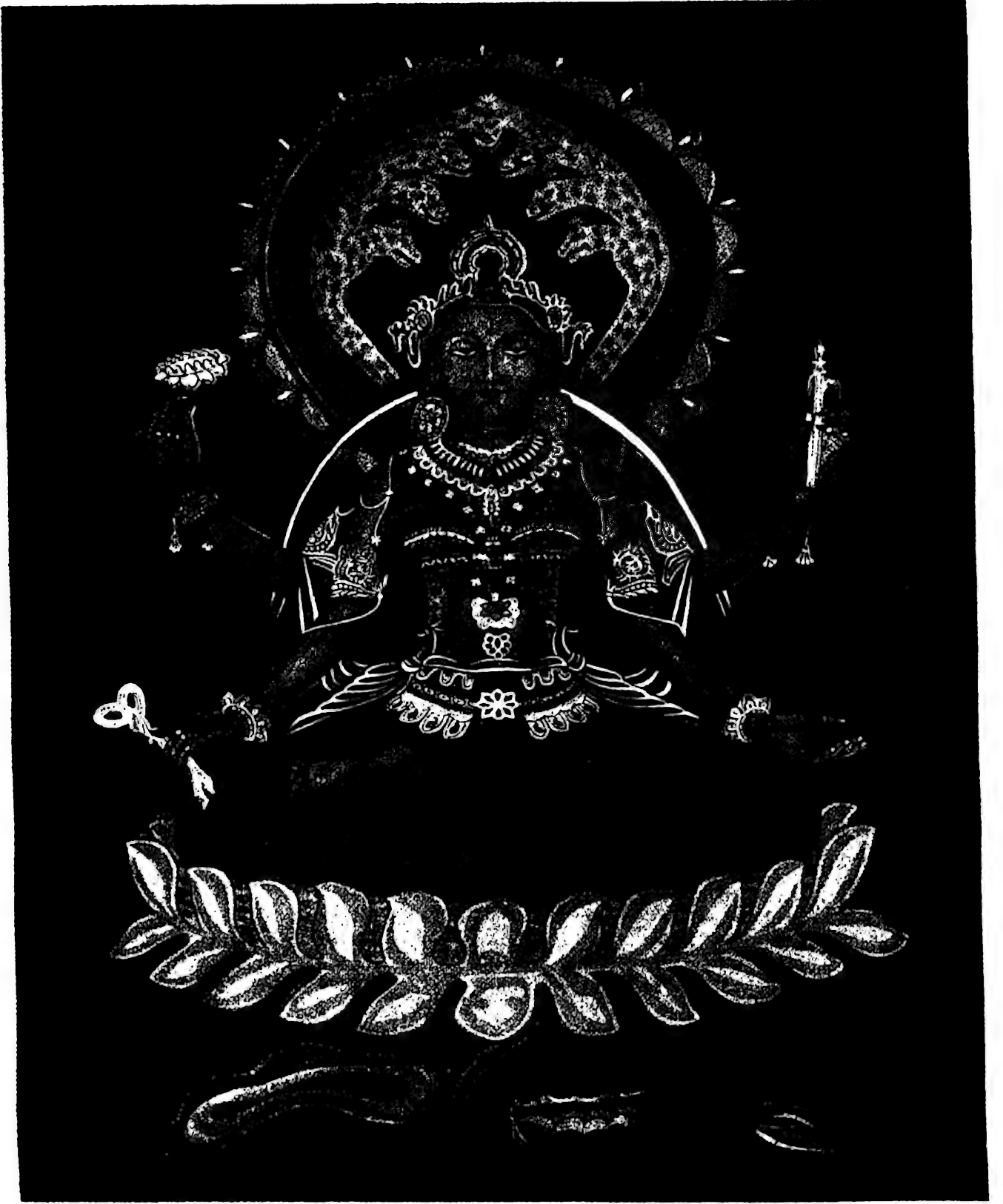

श्री पद्मावती देवी
Goddess Padmavati

चित्रकार - जयन्ती शर्मा

(कॉपीराइट सागरभाइ नवाच अमदावाद)

INTRODUCTION

THE purpose and scope of an introduction in these days have become much wider. Many a time it is not merely an introduction to the work which is being published but is also an introduction to the subject treated therein. That is not all. A history of the subject treated is expected to be given, and in giving the history the writer of an introduction is also expected to solve knotty historical as well as antiquarian problems relating to the subject. Thus an introduction is many a time more in the nature of an independent treatise than confined strictly to its original purpose of introducing the reader to the work.

It is natural, when a subject treated is abstruse or is such that about whose utility diverse conflicting opinions are held or about which doubt is raised whether it can have a place at all amongst the scientific subjects, that more is expected of the writer of an introduction. However, unless the writer can assume that the class of readers for whom the introduction is meant is sufficiently educated and cultured in the lores of the day his task becomes difficult. He may be unnecessarily occupied with the elementarily phases of the subject and may not be able to do full justice to the comparatively advanced and important phases thereof.

The writer has also to bear in mind that the class generally interested in the present subject in this country is comprised largely of members who, though very educated and cultured according to the ancient modes of instruction prevailing in India, are yet comparatively ignorant of the English language and many a time do not have even tolerable acquaintance with the modern thoughts and culture.

While writing therefore, this part of the introduction dealing with the general aspect of the subject, the writer has kept in view before him the well educated reader who is well conversant with the Eastern as well as the Western thoughts; but while writing the remaining parts he has kept in view the other class also.

The work here published is a Jain Tantra entitled "Sri Bhairava Padmavatikalpa." The subject treated therein is Mantrika worship of goddess Sri Padmavati, who is a deity attendant on Sri Parshvanatha the 23rd of the 24 Tirthankaras worshipped by the Jains.

This brings us to the subject of 'Mantra' or magic which is common to all early religions. We shall quote here what Sir John Woodroffe says on the subject of magic and magical symbolism in his work "Shakti and Shakta."

MAGIC AND MAGICAL SYMBOLISM

"It has been practised, though condemned, in Christian Europe. . . . It has been well observed that there are two significant facts about occultism namely its catholicity (it is to be found in all lands and ages) and its amazing power of recuperation after it has been supposed to have been disproved as mere superstition."

* * *

Magic was dismissed by practically all educated men as something too evidently foolish and nonsensical to deserve attention or inquiry. In recent years the position has been reversed in the West, and complaint is again made of the revival of witchcraft and occultism today. The reason of this is that modern scientific investigation has established the objectivity of leading phenomena of occultism. For instance, about a century or so ago it was still believed that a person could inflict physical injury on another by means other than physical. And this is what is to be found in that portion of the Tantra Shastras which deal with the Shatkarma. Witches confessed to having committed this crime and were punished therefor. At a later date, the witchcraft trials were held to be evidence of the superstition both of the accused and accusers. Yet psychology now allows the principle that Thought is itself a Force, and that by Thought alone, properly directed, without any known physical means the thought of another, and hence his whole condition, can be affected. By physical means I mean direct physical means, for occultism may, and does avail, itself of physical means to stimulate and intensify the force and direction of thought. This is the meaning of the magic rituals which have been so much ridiculed. Why is black the colour of Marana Karma? Because that colour incites and maintains and emphasizes the will to kill. So Hypnotism (Vashikaranam) as an instance of the exercise of the Power of Thought makes use of gestures, rotatory instruments and so forth."

"The Magician having a firm faith in his (or her) power (for faith in occultism as in religion is essential) surrounds himself with every incentive to concentrated, prolonged and (in malevolent magic), malevolent thought. A figure or other object such

as part of the clothing, hair, nails and so forth of the victim represents the person to be attacked by magic. This serves as the 'immediate object' on which the magical thought is expended. The Magician is helped by this and similar aids to a state of fixed and malignant attention which is rendered intense by action taken on the substituted object. It is not of course the injuries done to this object which are the direct cause of injury to the person attacked, but the thought of the magician of which these injuries are a materialisation. There is thus present the circumstance which a modern psychologist would demand for success in a telepathic experiment.

* * *

In all cases the general principle is the same, namely the setting in motion and direction of powerful thought by appropriate means."—Shakti & Shakta: Chapter III, 2nd Edition, pp. 55–57.

Those who give a psychological explanation of this phenomenon "would hold that the magical symbolisms are without inherent force but work according to race and individual characteristics on the mind which does the rest. Others believe that there is an inherent power in symbolism itself, that the "symbol," is not merely such but an actual expression of, an instrument by which, certain occult laws are brought into play. In other words the power of "symbolism" derives not merely from the effect which it may have on particular minds likely to be affected by it but from itself as a law external to human thought. Some again (and Indian magicians amongst others) believe in the presence and aid of discarnate personalities (such as the unclean Pishachas) given in the carrying out of occult operations."

* * *

"There has been, and is, a change of attitude due to an increase of psychological knowledge and scientific investigation into objective facts. Certain reconciliations have been suggested, bringing together the ancient beliefs, which sometimes exist in crude and ignorant forms. These reconciliations may be regarded as insufficiently borne out by the evidence. On the other hand, a proposed reconciliation may be accepted as one that on the whole seems to meet the claims made by the occultist on one side and the scientific psychologist on the other. But in the present state of knowledge it is no longer possible to reject both claims as evidently absurd. Men of approved scientific position have, notwithstanding the ridicule and scientific bigotry to which they have been exposed, considered the facts to be worthy of their investigation. And on the psychological side successive and continuous discoveries are being made which corroborate ancient beliefs in substance, though they are not always in consonance with the mode in which those beliefs were expressed. We must face the fact that (with religion) occultism is in some form or another a widely diffused belief of humanity. All however will be agreed in holding that malevolent Magic

is a great Sin. In leaving the subject of magic I may here add that modern psychology and its data afford remarkable corroboration of some other Indian beliefs such as that Thought is a Force, and that its operation is in a field of Consciousness which is wider than that of which the mind is ordinarily aware."—Shakti & Shakta: Chapter III, 2nd Edition, pp. 57 to 59.

THOUGHT FORCE

That Psychology nowadays considers that 'Thought' itself is 'Force'—a form of energy and that as stated above various physical results follow through concentrated attention and specially when it assumes emotive form, we shall substantiate by extracts from various works. In his work entitled "Thoughts are things", William Walker Atkinson, while generally showing that Thought is a form of energy quotes Prof. Ochorowicz:

"Every living being is a dynamic focus. A dynamic focus tends ever to propagate the motion that is proper to it. Propagated motion becomes transformed according to the medium it traverses. Motion tends always to propagate itself. Therefore when we see work of any kind—mechanical, electrical, nervic, or psychic—disappear without visible effect, then, of two things, one happens, either a transmission or a transformation. Where does the first end, and where does the second begin? In an identical medium there is only transmission. In a different medium there is transformation. You send an electric current through a thick wire. You have the current, but you do not perceive any other force. But cut that thick wire and connect the ends by means of a fine wire; the fine wire will grow hot; there will be a transformation of a part of the current into *heat*. Take a pretty strong current and interpose a wire still more resistant, or a very thin carbon rod. The carbon will emit *light*. A part of the current then is transformed into heat and *light*. This light acts in every direction around about, first visibly as light, then invisibly as heat and as electric current. Hold a magnet near it. If the magnet is weak and movable, in the form of a magnetic needle, the beam of light will cause it to deviate; if it is strong and immovable, it will in turn cause the beam of light to deviate. And all this from a distance, without contact, without special conductors. A process that is at once chemical, physical and psychical, goes on in a brain. A complex action of this kind is propagated through the gray matter, as waves are propagated in water. . . . Regarded on its physiological side, an idea is only a vibration, a vibration that is propagated, yet which does not pass out of a medium in which it can exist as such. It is propagated as far as other like vibrations allow. It is propagated more widely if it assumes the character which

subjectively we call emotive. But it cannot go beyond without being transformed. Nevertheless, like force in general, it cannot remain in isolation, it escapes in disguise." Prof. Ochorowicz says further "Thought stays at home, as the chemical action of a battery remains in the battery; it is represented by its dynamic correlate, called in the case of the battery, a current, and in the case of the brain—I know not what; but whatever its name may be, it is *the dynamic correlate of thought*. I have chosen the term 'dynamic correlate.' There is something more than that; the universe is neither dead nor void. A force that is transmitted meets other forces, and if it is transformed only little by little, it usually limits itself to modifying another force at its own cost, though without suffering perceptibly thereby. This is the case particularly with forces that are persistent, concentrated, well seconded by their medium; it is the case with the physiological equilibrium, nervic force, psychic force, ideas, emotions, tendencies. These modify environing forces without themselves disappearing; they are but imperceptibly transformed, and if the next man is of a nature exceptionally well adapted to them, they gain in inductive action."—Thoughts are Things pp. 22 to 25.

What Prof. Ochorowicz calls dynamic correlate of thought has not been yet scientifically named and is known by various names such as 'thought force', 'dynamic thought', and 'mind power'. These terms, however, cover the static as well as dynamic phases of the thought-currents. The better terms would be 'thought-vibrations', 'thought-waves', 'mental currents', etc. "The matter of names, however, is not important, the vital fact being that every person is constantly sending forth mental currents of different degrees of power, character and quality, which often travel to great distances, and which coming in contact with the minds of persons in whom is manifested a degree of harmony with the character of the thought, there tends to induce or reproduce the original thought, emotion, feeling, desire or other mental state." Thoughts are Things pp.-29-30.

Prof. Ochorowicz says "It (thought) is propagated more widely if it assumes the character which subjectively we call emotive." There are, however, "certain fixed persistent abstract ideas which form mental images as clearly defined as the strongest feeling, desire, or emotion—for instance, the result of the concentrated thought of an inventor, scientist, or artist, which produces a mental image of a remarkable

degree of depth and clearness, from which emanate thought waves of unusual power and vitality." *Thoughts are Things*—p. 33.

We may refer the reader who may be anxious to pursue the subject further to another work by the same writer entitled "*Thought Force in Business and Everyday Life*", which will convince him how the dynamic force acting in all matters relating to the Practical Mental Science is really 'Thought' and how it develops into personal magnetism or psychic influence giving distinct personality to each. Again the whole subject has been treated by what is termed the new Psychology and has been set forth succinctly by the same writer in his work "*The New Psychology*." This work is principally relied on and utilised while treating the subject in the following pages, and the writer acknowledges his indebtedness to the learned author thereof.

NEW THOUGHT-NEW PSYCHOLOGY

A new set of psychologists began working along the lines of a utilitarian psychology—a psychology that could be used in every day life, a psychology that was workable. They unconsciously worked along the lines of what is now called the pragmatic school of thought—"the school that holds that the truth and value of a science, philosophy, or idea, consists of its value when applied and set to work." An important feature of the new psychology has been the raising of certain little-understood phases of mental activity from the region of the occult and mystical, and the placing of them among the recognised and at least partially understood phenomena of psychology." But what was formerly regarded as a part of "abnormal psychology" especially that wonderful field of mental activity outside the range of consciousness, generally known as the "sub-conscious", "subjective", or "subliminal" fields, is now freely accorded a place in the normal psychology. Not only that, but "these fields are now regarded as containing within them at least nine-tenths of our mental activities." "*The New Psychology* has succeeded in showing that, so far as its investigations have extended, there is no super-natural—that every-

thing is natural—that what has been considered super-natural is merely natural phenomena the nature of which has not been understood—that natural law and order is ever in evidence in these newly understood phases of the mind.” It has considered how these may be turned to account in the everyday lives of the people both in the regions of developing desirable qualities and in the restraining and inhibiting of the undesirable ones. The best authorities on the subject are Lewes, Von Hartmann, Hamilton, Taine, Maudsley, Kay, Carpenter, Halleck, Prof. Gates, Jastrow, Schofield and Sir Oliver Lodge. Leibnitz, we may state here, was the discoverer of the unconscious activities of the mind. The famous philosopher Schopenhauer also was in this respect a fore-runner of the psycho-analyst Freud. Prof. William James has criticised the Sex theory and medical materialism of the Freudian School and deprecated attempts at re-interpretation of religious experiences of mystics and others on the assumption of universal applicability of the Sex-theory. The New Psychology though recognizing the sub-conscious phase of the mind does not accept the sex-theory nor the medical materialism as any explanation of mysticism or occultism. Although the New Psychology does not hold the activities of sub-conscious plane of mind as supernatural, “it admits the existence of a superconscious region or plane of mind which has activities which may be considered supernormal and unusual. To some favoured ones of the present race there come flashes from this wonderful region of mind, and we call them genius, inspiration, intuition, etc.”

IMAGINATION

“The New Psychology regards the faculty of Imagination in its creative aspect with a degree of consideration foreign to the older view.” It considers it a positive faculty and urges its scientific control and development. How that can be done is a matter of details.

In combination with Desire and Will, Imagination develops desirable faculties of mind and builds up character. It is thus, much useful for self-development and unfoldment of the latent powers of

mind. This happens under the two well known laws viz. The Law of Materialization and the Law of Attraction. Under the operation of the first law, thought tends to materialize itself into objective reality; and under the operation of the second, it tends to draw to itself the particular materials conducive to its materialization and expression. The outward manifestation also, that is attainment of any object thought of, takes place under the operation of the same two laws.

It will be noted, therefore, that the Visualisation, that is to say seeing vividly in imagination, is the first step towards attainment. The entire creative and inventive work of man is simply the result of the materialization of his imaginings. But imagination should be distinguished from its negative form "Fancy" i. e. "Day dreaming." Fancy is involuntary imagination and is without purpose or use. It is a mild form of mental intoxication tending to weaken the Will. Positive imagination is to a purpose and results in action. In its positive phase, Imagination supplies the mould, pattern, or die for the materialization of our ideals.

Imagination means the power of the mind to form images. It is a power more or less constantly exercised by every individual. If the imagination is strong and rich, we have the poet, the musician, the painter, the sculptor, the writer, or the orator—all those who create new forms. Good poetry produces a clear and distinct image in the mind of the reader, not a vague, misty, undefined thought. The poet must therefore have a living imagination to produce vivid images in the mind of the reader. Emerson expresses this fact very lucidly thus:

"The moment our discourse rises above the ground-line of familiar facts, and is inflamed with passion or exalted by thought, it clothes itself in images. A man conversing in earnest, if he watch his intellectual processes, will find that a material image, more or less luminous, arises in his mind, contemporaneous with every thought which furnishes the vestment of the thought. Hence, good writing and brilliant discourse are perpetual allegories. This imagery is spontaneous. It is the blending of experience with the present action of the mind. It is proper creation. It is the working of the original cause through the instruments he has already made. The poet, the

orator, bred in woods, whose senses have been nourished by the fair and appeasing changes of a country life, shall not lose their lesson altogether in the roar of cities or the broil of politics. At the call of a noble sentiment, again the woods wave, the pines murmur, the river rolls and shines, and the cattle low upon the mountains as he saw and heard them in his infancy. And with these forms, the spells of persuasion, the keys of power, are put in the orator's hands."

"And Indian Fakir can cause spectators to see lions, tigers, elephants, etc., emerge from a tent and furiously attack each other. By long practice of concentration the fakir attains such a degree of perfection in the exercise of the image-making power of the imagination that, through the operation of another law—telepathy, or the transmission of an image from the mental sphere of one person to that of others—the spectators around are made to see as an external reality, the imaginative creation of the fakir." "Ars Vivendi" by Arthur Lowell pp. 106-7, 6th Edition.

These are the instances of the concentrated imagination. When, however, a man loses control over his imagination, this very concentrated imagination produces insanity; and to the affected person, images become clearly visible as the sight of flesh and blood through creative power of the imagination. "The explanation of Magic, sorcery, Witchcraft, second sight, Apparitions and Ghosts is to be found in the Imagination." Just as a morbid idea will eventually bring about a morbid state of body, so a healthy idea will bring about a healthy state of body, and this is the principle on which cures are effected of such diseases as insanity, paralysis, ague, etc. "In fact the force of the healthy imagination is even more powerful in healing, strengthening, and ennobling man than the diseased imagination is in weakening debasing and enthralling him in the bonds of pain, misery and disease." What is required is imagination concentrated and the Will firmly fixed. We may here quote Arthur Lowell from his work "Imagination and Its Wonders" on the Magical Image at pp. 120-1, 1st Edition.

"The Magical Image has played its part amongst all sorts and conditions of men and

women, in every age, in every country. In the most barbaric African village its properties are as well known as in the most ancient civilizations. An image of a person was made of wax, wood, clay or anything else that was suitable to the purpose and pins, nails and daggers were struck all over it with intention of communicating the wound to the victim at a distance, and torturing and killing him according to the intensity of the hatred."

In Indian Magic also many a time such images and objects are employed in Māraṇa Karma.

It is generally supposed that witchcraft originated in the middle ages of Europe. It is quite true that during the middle ages these practices were more openly prevalent but they were carried on in secret here and there among all nations. In a Papal Bull issued by John XXII in 1317, he complains that his own courtiers were proficient in the Black Art. They had mirrors, rings, circles, and magic images by means of which they could see what was transpiring at a distance, and could wound and kill."

✓ DESIRE

"The strongest desire—the most rigid Will will fail to accomplish any thing for the person who has not formed a clear mental picture or the idea of exactly what he does want."

One must, therefore, pick out the sense that he really wants to accomplish or to acquire and then proceed to build up the strongest kind of desire for those things. In this way he sets into operation the law of thought—materialization and incidentally the law of attraction; and preliminary operations whereby the ideal becomes real are started in motion. Very often you may not be able to form complete mental image at the start, but then try to see the first stage or the first detail as clearly as possible. Then gradually fill in further details till the picture is complete. Then long for it, crave it, hunger and thirst for it. Desire is the fire which produces the steam of action. No matter how a man may be otherwise well qualified with powers of perception, reason, judgment, application or even will—unless he also possesses strong desire for accomplishment the other faculties will never be brought into action. Desire is the great inciter of mental and physical activities and arouser of the Will.

"Desire is at the bottom of all feelings." People have got into the habit of speaking

and thinking of desire as an unworthy, low, animal, selfish quality and speak of high desires, aspirations, ambitions, zeal, ardour, love etc.

These are nothing but desire.

Preceding every action there must be desire either conscious or unconscious. Even those people who make a virtue of Renunciation of Desire, and who claim to have "conquered desire absolutely" are acting in response to a more subtle form of Desire."

It is really carrying out the desire not to desire certain things. "Lack of desire" to do a certain thing simply means a desire to pursue an opposite course of conduct and action. Desire is manifest in every action and refraining from action, so long as one has capacity for action. There are good desires as well as bad, and one must learn to distinguish between them. The clearer the mental image of the object of the desire the greater will be the degree of the desire manifested—all other things being equal." One may feel hungry in a degree; but when he sees some particular object of taste, the hunger becomes far more intense. The threefold method, Auto-Suggestion, Visualisation and Acting-out-the Part, will develop desire. The objects of development of desire are that (1) Will may be called into play and that (2) Desire Force may be set into activity and thus begin in its 'drawing', attracting 'work.' 'Many people want things but they do not want them hard enough.' No mere wishing or sighing for a thing will do. The desire must be intense, eager, longing, craving, hungry, ravenous, such that will result in mightier effort and achievement. The ardent, keen desire will clear away the undergrowth of the path of success. It will attract to you the people and things, circumstances and environments, etc., needed for its satisfaction. Desire is the soul of the law of attraction. pp. 228-9 chapter VII, "Secret of Mental Magic" by William Walker Atkinson.

It is generally thought that Will is the great motive power of the mind. This is not correct, unless it is assumed that Will is the active phase of desire. Desire is the motive power that imparts energy to the action. The Will is more as a guiding, directing

force which applies the energy of the desire. Will is cold and steely—desire is glowing with heat and fire.

All the same, desire requires to be directly controlled and submitted to the judgment of reason and control of the Will.

All mental states have their preceding causes and reason. "All desires emerge from sub-conscious region either in the sense of being reproduction of some emotion, or feeling previously experienced and brought into the field of consciousness as a memory, or else in the sense of being a response of the stored up impressions brought into activity in response to the appearance of some outside thing which awakens the latent forces. "In both the cases, Desire emerges from the sub-conscious mind and is a phenomenon of that region of the mind." The Desire is connected on one side with the feeling and emotional phase of mentation and on the other with the phase of volition or Will. "A desire must always have as its basis some antecedent feeling or emotion, and at the same time some antecedent experience, either racial or individual." One never desires a thing unless he has some subconscious experience of feeling; and moreover this expression presupposes some antecedent knowledge of the thing desired. Here we may state what Indian Philosophy says on the point. According to it the sequence is expressed in three words: जानाति, इच्छति, यतते—One knows, desires and strives for (an object). 'Desires grow by the amount of attention and interest bestowed upon them; and wither and decay in proportion that the attention and interest are withheld from them.' Compare the following from Manu-Smriti II Adhyāya:

“न जातु कामः कामानामुपभोगेन शाम्यति ।
हविषा कृष्णवर्त्मैव भूय एवाभिवर्धते ॥”

Desire is never calmed by the enjoyment of the objects of desire; it only grows stronger like fire (fed) by oblations.

✓TRIPLE KEY OF SUCCESS

The triple key of Attainment is (1) Desire a thing most in-

tensely, (2) Earnestly and Confidently expect it, and (3) Will persistently in the direction of action to bring it about.

CONFIDENT EXPECTATION

We have fully considered the first element of success viz. Insistent desire. We shall now take up the next in order viz. Confident Expectation. It is a combination of the mental states known as Faith, Hope and Enthusiasm, each of which possesses the power of arousing and maintaining energy, and all inciting to action. Faith unsupported by reason and judgment degenerates into blind credulity and irrational belief, yet supported by reason and judgment it is a most positive mental quality and incites the individual to activities otherwise impossible. Unless a man believes in a thing, he cannot manifest hope and enthusiasm with regard to it and without this trio, very little can be accomplished in life. What is essential is faith and confidence in oneself and in one's activities. Such a man may recognise that others are more intelligent and more qualified than himself, yet he feels deep within himself that there is something in him that is bound to bring success, something that is sure to pull him through somehow or other. Such a man sometimes thinks that it is something outside of himself which in some way works through him. He may call it 'destiny,' 'luck' or 'my star' but the principle is always the same. It is always a faith in himself. The feeling can be well expressed by the words 'I can and I will.' 'Unfaith in one's self has a deadening, depressing, negative influence and acts like a wet blanket in the direction of smothering the fire or desire.'

There is something contagious about Faith and Unfaith. The world believes in one who believes in himself; and equally so, lacks faith in one who lacks faith in himself. Hope is the connecting link between faith and enthusiasm and represents the essence of confident expectation. When based upon reason and judgment it is a positive mental quality the expression whereof is known as optimism. It is based upon faith and belief and it possesses animating principle of enthusiasm.

It not only believes a thing but acts upon the belief. It inspires as well as urges on. Tanner says, "To believe firmly is almost tantamount in the end to accomplishment." Maudsley says, "Aspirations are often prophecies, the harbingers of what a man shall be in a condition to perform." "Simple attention is a powerful psychological force, and when it is blended with hopeful expectancy, it becomes almost irresistible. Attention is the essence of will and hope is one of the most positive emotions; so in expectant-attention we have a combination of both the motive and the emotive mental forces." "Enthusiasm is seen to be but desire fanned by the breezes of faith and hope until it attains the fierce heat of fervor and zeal. It arises from the rousing of the emotive phase of the mind and the blending thereof to the imaginative faculties and the will. In enthusiasm the subconscious is linked with the conscious; emotion is joined to imagination and will. Enthusiasm balanced by reason and judgment, manifests as intense earnestness. This earnestness is an important factor in all successful undertakings and enterprises. It is contagious. It manifests as personal magnetism. All of us emit a sphere, aura, or halo, impregnated with the very essence of ourselves; sensitives know it, so do dogs and other pets. Confident Expectation is based on Faith; and Hope is the connecting link between the insistent desire and persistent will, all of which combine to contribute to attainment.

WILL

It is difficult to conceive of the Will acting without desire, consciously or subconsciously exerted. Will may be considered in its three-fold aspects. (First aspect of Will is Desire; second, Choice; and the third, Volition or action.) In its first phase some distinguish Will from Desire; others hold that it blends with Desire so closely that it is difficult to distinguish. The second phase is according to many the principle function of the Will. It is the act of determining, deciding, making choice, etc. The average person is governed almost altogether by feelings of emotions in making choices of this kind. Only a few who have done some degree of mental control are able to subject

these conflicting desires to the bright light of the reason and to determine accordingly. In its third phase the latent power of Desire is released in accordance with the decision made. There is a point of hesitation before desire springs into will-action—the point of indecision which occupies but a small fraction of a second; in fact, particularly among the lower members of the race, the action is almost automatic and without rational consideration. Some desires never pass into the stage of action, but are held back either by the power of conflicting desires, or else from want of energy in the desire itself. The new Psychology does not content itself with a mere discourse upon the nature and action of the will; it proceeds to inform one how the will may be trained and applied to the best advantage.

Prof. William James advises the practice of doing things disagreeable to oneself, things which one does not want to do—as a means of strengthening the will. It increases the resisting power of the Will and serves one well in time of need.

Prof. Halleck also says: "Nothing schools the Will, and renders it ready for effort in this complex world better than accustoming it to face disagreeable things. A Will schooled in this way is always ready to respond, no matter how great the emergency. While another would be still crying over spilt milk, the possessor of such a Will has already begun to milk another cow." It is by doing that we learn to do; by overcoming that we learn to overcome. The essence of Will is action. Persistency, doggedness, and stamina are the qualities of Will. Emerson said "I know no such unquestionable badge and ensign of a sovereign mind as that of tenacity of purpose, which, through all changes of companions or parties or fortunes, changes never, bates no jot of heart or hope, but wearies out opposition and arrives at its port."

"In the persistent Will we have the manifestation of Will in action, and also in the form of the steadying, and holding in place of the whole mental force. One of the characteristics of the Positive Will is its quality of persistence—that quality which manifests in steadfastness, firmness, and constancy in carrying out and pursuing the

design, business, or course commenced or undertaken; perseverance in the face of obstacles and discouragements; steadfastness and determination in the face of opposition or hindrance. Stability; decision; perseverance; fixedness of purpose; tenacity—these are the terms applied to the persistent Will. Persistency combines the qualities of continuity and firmness—steadfastness and “stick-to-it-iveness!”

Another writer says, “He who is silent is forgotten; he who does not advance falls back; he who stops is overwhelmed, distanced, crushed; he who ceases to become greater, becomes smaller; he who leaves off gives up; the stationary is the beginning of the end—it precedes death; to live is to achieve, to Will without ceasing.”

MENTATIVE ENERGY AND MAGIC

The reason why we are dealing with Imagination, Desire and Will at some length is that they form the Substratum of Magic, White as well as Black. Desire-Force and Will Power are but Phases of the same force—Mentative Energy. They are really its two poles. The Will Power being the motive and the Desire Force being the emotive pole. Arthur Lovell in his book entitled “Imagination and its Wonders”, says that the pith and marrow of Magic Power is Imagination and Will employed in the right way in case of White Magic and Imagination and Will employed for evil in case of Black Art or Sorcery. Certain Laws of nature such as the Sympathy and Antipathy of particular objects to each other are observed and made use of and certain methods more or less efficacious for exciting the Imagination and strengthening the Will are employed. We would refer the readers who are interested in the details of the working of Magic on an object near as well as distant, to the work “The Secret of Mental Magic” by William Walker Atkinson. All the same, we would give in substance what is stated on the subject in the said work. Mentative Influence consists in the Induction of Mental State in other persons. This Induction operates along two lines. (1) The line of Mental Suggestion which requires a physical agent; and (2) the line of Mentative Currents,

which produce their effect directly on the mind of the person without the operation of the physical senses, or the physical agents necessary to reach such senses. Mental Suggestion, Persuasion, Charming, Fascination, etc., are instances of the first kind, as they create impression through a physical agent viz, the five senses and principally those of seeing and hearing. Personal Magnetism or Psychic Influence and Telementation i.e. influence at a distance are instances of the second kind, as the impressions here created are not through any physical agent or senses. In case of Hypnotism and Mesmerism both Mental Suggestions as well as Mentative Currents act and induce particular Mental States in persons towards whom the force is directed.

Now we shall show the practical working of Telementation. The Mentator-Magician usually concentrates upon the person or thing that he wishes to affect, and then, by the use of his will, he sends to that person or thing a current or currents of Desire Force or Will Power, or both. The degree of effect depends largely upon the degree of concentration of the Magician and the degree of concentration depends upon the Will. The usual plan is to use the concentrated Will to form a clear Mental image of a person or thing to be affected, and then proceed as if he was actually present. The clearer the image, the greater the degree of concentrated Will employed; and consequently the greater the degree of the projecting power of the current. If the person against whom the force is directed believes in and fears such adverse influence he renders himself negative and thereby he is put in a receptive state; and is easily influenced. If however he asserts his individuality and assumes the fearless attitude, he may defy all such attempts to influence him adversely. The underlying principle of witchcraft and Voodoo practices is the same. The wax images and pith-balls etc. used by them are only the agencies for concentration of the Will. The material objects employed absorb the magnetism of the practitioner, whether good or bad, and do affect persons coming in their contact—and the efficacy of “charms,” sacred relics etc, depends upon

this fact; but the greatest effect is produced by the suggestions of fear to the minds of the persons sought to be affected. The key of Telementation is Mental Visualisation. "Visualisation is to Telementation what the pattern is to the maker of objects; what the plans of the Architect are to the builders; what the "mould" or "matrix" is to the casters of forms. It is skeleton around which the Materialisation of Thought Forms occurs. "As is the Mental Matrix so is the mental form and as is the mental form, so is the physical materialisation." "The Visualised mental Image is the Matrix or Mould into which the Mentative Energy is poured, and from which it takes form; and the form of the Mentative Energy, so created, is what we have called the Mental Image; and around this Mental Image, the deposit of Materialisation forms and thus does Ideal become the Real." The Mentative Energy is of Desire and Will. Then you must hold the Mental Image constantly before you regarding it as something real and not mere imagination which will proceed to surround itself with the material necessary to give it material objectivity or Materialisation.

The working principles of the New Psychology, excluding as far as possible all technical and theoretical discussion have been summarised above without going into the ultimate nature of Mind or Soul.

The keynote of the discussion is that ideas, thoughts, feelings, emotions, desires, imagination and other mental states properly-developed controlled and directed by Will and Ego bring about marvellous results and that it is the real mechanism of Successful occult operations also.

TELEPATHY AND CLAIRVOYANCE

That the principle of Telementation which underlies the working of magical processes is not a wild speculation but a scientifically proved fact will be seen from the following discussion about Telepathy and Clairvoyance.

We may state that 'Telepathy' means thought-transference or communication of impressions of any kind from one mind to another

either conscious or subconscious, independently of the normally recognized senses. Clairvoyance means (i) the vision of normally invisible, hidden objects near at hand, (ii) the knowledge of events happening at a distance beyond the range of normal senses, and (iii) vision into the past or future. The last is sometimes called prophetic vision or prophecy.

Telepathy itself was unknown as a demonstrable fact before 1882. Rudolf Tischner in his work *Telepathy and Clairvoyance* says—
 “some years ago, telepathy and clairvoyance were fully recognized facts. Philosophers like Hegel, Schelling, Schopenhauer, T. H. Fichte, Von Hartmann, and a number of prominent medical men spoke of them as accepted facts.” P. 6.

Our readers will be interested to learn about the conclusions drawn by Rudolf Tischner and his psychic theory explaining Telepathy and Clairvoyance in his said work.

We give the same below.

RUDOLF TISCHNER ON TELEPATHY AND CLAIRVOYANCE

Tischner has given experiments * carried on by him jointly with Dr. W. Von Wasielewski in 1912–1913 dealing with telepathy and clairvoyance, and also his theory explaining the same which is a psychical theory. He criticises the physical theory and the views of other writers. He says further that apart from instances of sub-conscious memory, the mediums give us information really gained supernormally connected with their sub-conscious minds in some way but not belonging primarily to the life of their individual minds, and which they cannot have gained through their senses.

“It gives us the impression that the sub-conscious mind—to make use of a spatial image—is not so clearly separated from its surroundings, but represents a mental field which is connected with the ‘non-individual’ or super-individual mind. If we descend from our surface consciousness we gradually reach sub-conscious mental regions which cease to belong to a single individual—as when we follow a watercourse into the interior of a mountain we reach regions where we lose sight of the single

*A large number of instances of spontaneous telepathy are collected in the work ‘Phantasms of the Living’ 2 vols. by Gurney, Myers and Podmore.

stream but where water pervades the ground all around us. These very deep layers of the sub-conscious mind would thus share in a non-individual or super-individual mind and so have a knowledge of things which are quite unattainable and incomprehensible to the individual mind. The difficulty of raising this knowledge to the surface consciousness would account for the scarcity of these phenomena."

"E Von Hartmann, when speaking about telepathy, in much the same way refers to the 'telephonic connection with the Absolute,' and he thinks of individuals as in direct mental connexion with the Absolute. xxx Again we meet E. Becher with his views on the "super-individual mind."

"A well-known neurologist, Kohnstamm (Journal f. Psychol. und Neurol., 1918, Beiheft), has lately tried to prove that in the deepest hypnosis a stratum is reached which is beyond the individuality and the personality. His subjects maintain that in the deepest hypnosis they can dive down to strata of their subconscious mind which are impersonal. The utterances of this deepest layer are of general applicability and no longer have to do with the person in question and his characteristics; it might just as well apply to anyone else, as this subconscious mind always thinks objectively; Kohnstamm maintains that he has reached the universal, pure, super-individual, absolute-subject."

Rudolf Tischner in conclusion says:—

"I do not pretend to explain occult phenomena by the psychic theory alone; of course genuine physical manifestations require the co-operation of some sort of energy to produce them."

The facts of telepathy and clairvoyance shed new light on the old philosophical problem of how we are to conceive the inter-relation of body and mind. This field of research has a enormous influence on all departments of philosophy. "It extends," says the author, "further, to the philosophy of religion and to ethics; to both of these the question of how "spirit communes with spirit" is of no little significance."

The author also mentions:

"our attempt to explain telepathy and clairvoyance by a psychical theory and to

assume the existence of a super-individual mind have nothing to do with spiritualism. It is often supposed that persons who accept the facts of occultism, such as telepathy and clairvoyance, are to be identified with spiritualists. But it is essential to draw distinctions here. The fact that we have been led to experience telepathy and clairvoyance and to assume the existence of a purely mental factor to explain them, which has made the existence of a super-individual mind probable, does not prove anything about the fate of the individual soul. My investigations on telepathy and clairvoyance give me no information on the subject. The question whether the individual mind continues to exist or dissolves into the mass of the super-individual mind like a drop in the ocean, is a question which is not yet solved; the propositions of spiritualism seem to me still unproven."

W. W. Atkinson and Edward E. Beals in "Subconscious Power" offer apt remarks about the two phases of the so called "subconscious" (originally termed "unconscious"): the 'sub-conscious' and the "superconscious." They say:

"The former contains only that which is placed there by heredity, by suggestion of others, by the conscious experiences of the individual or by the imperfect reflection of the superconscious faculties before the latter have unfolded their message to the conscious mentality. The higher regions—the Superconscious—on the contrary contain much which man has never before experienced consciously or sub-consciously." P. 158
 "From the region of the Superconscious comes that which is not contrary to reason, but which is beyond ordinary reason. This is the source of illumination, enlightenment, genius, inspiration. This is the region from which the true poet obtains his inspiration, the exceptional writer his gift, the real seer his vision, the veritable prophet his knowledge. Many have received messages of this kind from the region of the Superconscious, and have thought that they heard the voice of God, of angels, of spirits—but the voice came from within. In this region are to be found the sources of Intuition. Some of the superconscious faculties are higher than others, but each has its own part to play. Many a man has received inspiration from within, and has given a message which has astonished the world. Many poets, painters, writers, sculptors, have acted upon the inspiration received from their superconsciousness. Certain great poems, certain great writings, certain great pictures, certain great statues, have about them an indefinable something which appeals to us and make us feel their wonderful strength—that mysterious quality absent from the productions of ordinary mental effort." PP. 159–160

"In addition to the offices and powers of the Superconscious which we have mentioned, there is another and a most important

function of that phase of the mentality which may be called "the protective power." p. 167

"Some of the ancients called it "the kindly genius"; others termed it "the guardian angel"; still others have thought of it as "my spirit friend". p. 167. It is really the superconscious self.

Dr. Francis Aveling, professor of psychology in the University of London, in his book, 'Psychology, The Changing Outlook' observes: "Another highly significant discovery, the full consequences of which for systematic psychology can hardly yet be estimated, is that of the Unconscious as a dynamic reservoir of psychical energy. Perhaps it is scarcely a too far-fetched use of analogy to compare this with the discovery of radio-activity in physics." p. 143

It is however not possible to draw a hard and fast line between the two phases of the subconscious.

"These activities frequently blend so into each other that it is most difficult to determine whether they belong to the higher or to the lower. There is, in fact, an indefinite intermediate area in which the higher and lower blend, mingle, and form combinations." P. 156. "Subconscious Power".

We shall conclude this discussion by quoting the views of Prof. William James in his famous work 'The Varieties of Religious Experience' 5th edition in lecture XX entitled "Conclusions". The author puts forward his hypothesis explaining the experiences of the mystics:-

"The *subconscious self* is nowadays a well-accredited psychological entity; and I believe that in it we have exactly the mediating term required. Apart from all religious considerations, there is actually and literally more life in our total soul than we are at any time aware of. The exploration of the transmarginal field has hardly yet been seriously undertaken, but what Mr. Myers said in 1892 in his essay on the Subliminal Consciousness * is as true as when it was first

*Proceedings of the Society for Psychical Research, Vol. VII P. 305. For a full statement of Myer's views see his posthumous work "Human Personality and its survival of bodily death."

written: 'Each of us is in reality an abiding psychical entity far more extensive than he knows—an individuality which can never express itself completely through any corporeal manifestation. The Self manifests through the organism; but there is always some part of the Self unmanifested; and always, as it seems, some power of organic expression in abeyance or reserve'. Much of the content of this larger background against which our conscious being stands out in relief is insignificant. Imperfect memories, silly jingles, inhibitive timidities, 'dissolutive' phenomena of various sorts, as Myers calls them, enter into it for a large part. But in it many of the performances of genius seem also to have their origin; and in our study of conversion, of mystical experiences, and of prayer, we have seen how striking a part invasions from this region play in the religious life.

Let me then propose, as an hypothesis, that whatever it may be on its *farther* side, the 'more' with which in religious experience we feel ourselves connected is on its *hither* side the subconscious continuation of our conscious life".

CONTEMPLATION COLOURS AND EMOTIONS

While dealing with the subject of contemplation of the deity presiding over a particular Mantra, in the present work as also other works of the same or similar nature, the reader will find it stated that the colour of the deity as all its apparels and ornaments should be contemplated as white, golden, red, blue or black according to the temperament or power ascribed to the deity or the nature of the object sought to be achieved by the worshipper. It is also laid down that the worshipper himself should put on garments of identical colour and should have a seat and a rosary also of the same colour.

What is the object underlying all these injunctions? It is, we should think, to give the Mental Energy of the worshipper in contemplation, the proper direction by exciting the imagination so that the appropriate mental state or emotion is induced and its colour reflected in the mental energy to bring about the desired object. The colours

laid down for contemplation there, the reader will find, vary from pure white to entire black as the object to be achieved is either positively good or extremely wicked. The intermediate colours represent the intermediate states of mind or emotions necessary for the achievement of particular objects. The subject is treated in details in a work entitled "The Human Aura" by Swami Panchadasi. We shall cull thereout a few passages throwing light on the subject or adapt therefrom as set forth below:

HUMAN AURA AND ITS SIGNIFICANCE

The human aura may be described as a fine, ethereal radiation or emanation surrounding each and every living human being. * * * It assumes an oval shape—a great egg-shaped nebula surrounding the body on all sides for a distance of two or three feet.

"It is also called 'psychic atmosphere' or 'magnetic atmosphere' of a person. In the sense of psychic awareness generally called 'feeling,' it is apparent to a large number of persons.' As a matter of fact, * * * the aura really extends very much further than even the best clairvoyant vision can perceive it, and its psychic influence is perceptible at quite a distance in many cases". P. 8.

In this respect it may be compared to a flame on the physical plane. The aura is a combination of colours reflecting the mental (particularly the emotional) states of the person to whom the aura belongs.

SCIENTIFIC RECOGNITION OF HUMAN AURA

"Leading authorities in England, France, and still more recently in Germany, have reported the discovery (!) of a nebulous, hazy, radioactive energy or substance around the body of human beings. In short, they now claim that every human being is radio-active, and that the auric radiation may be registered and perceived by means of a screen composed of certain fluorescent material, interposed between the eye of the observer, and the person observed". P. 13. It is termed by them the 'human atmosphere'. They have however failed to discover colour therein and apparently know nothing of the relation between auric colours and mental and emotional states.

COMPOSITION OF AURA

“The fundamental substance of which the human aura is composed is * * * best known under the Sanskrit term, *Prana*, but which may be thought of as Vital Essence, Life Power. etc. ” PP. 15-16.

PRANA-AURA

The vibratory movement of the prana-aura is like the heated air arising from a hot stove or lamp or from the heated ground. Human magnetism used in magnetic healing is the same as prana-aura. This prana-aura is colourless like a diamond or clear water in an average person but it is of a faint pink tinge and warm in a person of strong vitality. It is therefore known as “Vital Force” or “Nerve Force” and its vibrations as ‘vitality vibrations’.

METHODS OF DEVELOPING AURA

Having regard to the fact that the aura of an individual is an important part of his personality and affects and influences other persons coming in his contact, it is necessary that he should exert to develop his aura for acquiring desirable qualities and eradicating undesirable ones. The development of aura is thus an important factor in self-development and character-building. It can be achieved in two ways (1) by holding in the mind clear pictures of ideas and feelings desired and thus directly modifying the aura and (2) by contemplating mental images of the colours corresponding to the ideas and feelings desired. The latter method

“consists simply in forming as clear a mental image as possible of the color or colors desired and then projecting the vibrations into the aura by the simple effort of the Will.” PP. 76-77

The mental imaging of colours may be materially aided by concentration upon physical material of the right colour. By concentrating the attention and vision upon bright red ruby or bright green emerald one may be able to form a clear mental image of the respective colour. The attention instinctively takes up an impression of the colour, and consequently vibrations, from one’s surroundings; the latter therefore should be of the desired tint.

We shall now describe the various states of mind or emotions connected with the various colours—hues, * tints and shades shown in the aura of a person.

KEY TO THE ASTRAL COLORS

Red. Red represents the physical phase of mentality.

* * *

Blue. Blue represents the religious or spiritual phase of mentality.

* * *

Yellow. Yellow represents the intellectual phase of mentality.

White. White stands for * * Pure spirit.

* * *

Black. Black stands for the negative pole of Being—the very negation of Pure Spirit and opposing it in every way." PP. 27-28.

COLOURS AND EMOTIONS

The Red Group—The clear bright red shade indicates health, life-force, vigour, virility etc., and also strong pure natural emotions like friendship, love of companionship, love of sports, etc. When there are selfish or low motives behind, the shade grows darker and duller; it is muddy red shade. Red very near to crimson is the colour of Love. In its high phase it manifests as a beautiful rose tint. In case of coarse sensuality it manifests muddy crimson. In case of righteous anger it manifests vivid scarlet flashes, and uncontrolled rage deep dull red. The colour of avarice is a combination of dull dark red and dirty green.

The Yellow Group. Here also we find as many varieties of yellow indicating different kinds and grades of intellect. Orange represents pride of intellect, love of mastery and intellectual ambition. Pride—love of power has more of the red hue, but pure intellectual mastery less of it. Pure intellectual attainment and love of the same manifests a beautiful golden yellow. "Teachers of great spirituality have this 'nimbus' of golden yellow, with a border of

* Varied proportions in blending of primary colors produce 'hues'. Adding white to the hues, we obtain 'tints', while mixing black produces 'shades.'

beautiful blue tint, strongly in evidence." p. 34. This golden shade of yellow is comparatively rare; a sickly lemon colour is the indication of intellectual power in the great run of persons.

The Blue Group. A rich clear violet tint represents the highest form of spirituality, while the grosser phases of spirituality are indicated by darker and duller hues and shades until dark indigo verging on bluish black is reached. High morality is indicated by beautiful shades of blue. Purple denotes a love of form and ceremony and solemn grandeur in religion.

The Green Group—A restful green indicates love of nature and outdoor life, repose, quiet, etc.; a clear beautiful lighter green indicates sympathy, charity and altruistic emotion; another shade of green intellectual tolerance; a duller shade of green indicates tact and diplomacy; and a still duller shade insincerity, shiftiness, untruth, etc.; an ugly slate coloured green indicates low tricky deceit; and an ugly muddy green indicates jealousy, envious malice, etc.

The Brown Group: It represents desire for gain and accumulation—ranging from the clear brown of industrious accumulation to the murky dull brown of miserliness, greed and avarice.

The Gray Group: "Gray represents fear, depression, lack of courage, negativity, etc."

Black: It stands for "hatred, malice, revenge, and "devilishness" generally. It shades the brighter colors into their lower aspects." It stands for hate, gloom, grief, depression, pessimism, etc.

White: "White is the astral colour of Pure Spirit, as we have seen, and its presence raises the degree of the other colours, and renders them clearer. In fact, the perception of the highest degree of Being known to the most advanced occultist is manifested to the highest adepts and masters in the form of "The great White Light," which transcends any light ever witnessed by the sight of man on either physical or astral plane for it belongs to a plane higher than either, and is absolute, rather than a relative white. The presence of white among the astral colors of the human aura, betokens a high degree of

spiritual attainment and unfoldment, and when seen permeating the entire aura it is one of the Signs of the Master—the token of Adeptship.” p. 38.

The effect of colour on the moral and mental welfare of people is being recognized in western countries in as much as brighter colours are provided in schools, hospitals and other public buildings. It is said of a judge, in an American journal that he insisted upon his court-room being painted in light cheerful tints instead of old gloomy shades. He said that brightness led to right thinking and darkness to crooked thinking. He further said: “White, cream, light yellow and orange are the colors which are the sanest. I might add light green, for that is the predominant color in Nature; black brown and deep red are incentives to crime—a man in anger sees red.” This knowledge about colours is being utilized in therapeutics or mental healing also.

We may note here that deep concentrated thought or a strong desire or feeling sets up strong vibrations in the person's aura and produces thought-forms of varying shapes but of the colour of his aura. This thought-form is practically “a bit of the detached aura of a person charged with a degree of his prana, and energized with a degree of his life energy. So, in a limited sense, it really is a projected portion of his personality.” p. 54.

Just as an individual has his peculiar aura, so also places of abode or congregations have also their collective aura. The persistence of thought-forms gives various public and private places their characteristic atmosphere.

ĀTMARAKṢĀ AND PROTECTIVE AURA

Readers acquainted with Tantras will remember that as a part of the worship prescribed in Tantras and as the first and most important part thereof various forms of Ātmarakṣā are prescribed to be effected through recitation of Mantras. The object seems to be to protect the worshipper from adverse psychic influences i. e. by excluding the undesirable psychic influences while allowing an inlet for such as are desired by the worshipper.

We give below from the above mentioned book 'The Human Aura' the portion relating to 'The Protective Aura' the underlying principle of which is the same as of *Ātmarakṣā* in the Tantras.

The Great Auric Circle of Protection * * * is a shelter to the soul, mind and body, against outside psychic influences, directed, consciously or unconsciously against the individual.

"This Auric Circle is formed by making the mental image, accompanied by the demand of will, of the aura being surrounded by a great band of *pure clear white light*."

"It is a perfect and absolute protection, and the knowledge of its protective power should be sufficient to drive fear from the heart of all who have dreaded psychic influence, "malicious animal magnetism" (so-called), or anything else of the kind, by whatever name known. It is also a protection against psychic vampirism, or draining of magnetic strength."

"The Auric Circle, however, will admit any outside impressions that you really desire to come to you, while shutting out the others."

"The White Light is the radiation of Spirit, which is higher than ordinary mind, emotion or body and is Master of All. And its power, even though we can but imperfectly represent it even mentally, is such that before its energy and in its presence in the aura, all lower vibrations are neutralized and disintegrated." pp. 83-85.

The above remarks about human aura and its connection with various emotional states as also about protective aura are endorsed by William Walker Atkinson in his book entitled 'Mental Magic.'

MANTRA-HOW IT ACTS VIEWS OF WESTERN WRITERS

We have dealt with Thought-Force which is at the bottom of all mental processes as is now considered by modern thinkers. The Mantras, however, are not mere thoughts. They are made of sounds, which generally have meaning as words of a language usually have;

but they some times are only symbolic *apparently* having no meaning as in case of Mantrabījas but signifying something only by convention. A question naturally arises whether it is merely the Thought Force that brings about the result in a Mantra or whether the words and syllables comprising it also have, apart from the Thought Force, any effect and contribute towards the desired result. If the words or syllables of a Mantra had no particular effect, any words or syllables—or for the matter of that Thought Force alone—should be able to bring about the desired result. Before discussing the matter further we would state what some of the Western writers think about it and also what Tantra Shastra has to say in the matter.

Arthur Lowell in his book “Imagination and its Wonders” says as follows about Spells, Runes, and Mantras:

“Spells, Runes, Incantations, Conjurations, Charms, and Mantras are based upon the latent potency of sound when violently set in motion by the living Will and vivid Imagination. There being no hard and fast line between the various forces of Nature, one mode of motion is convertible into another mode. Under certain conditions, a form can be “heard” and a sound can be “seen”; for sound, like everything else in Nature, is a mode of motion of the subtle ether. Cosmic Ether itself is primarily divided into five modes of vibration by the action of the Great Breath. The mode with which the sound is connected is the Ākas’a, which is said by the ancient Sanskrit authors to be the first differentiation of Primordial Matter.

“The influence of sound must therefore be exceedingly powerful in bringing about magical results, for it is directly connected with the most subtle of the five kinds of Cosmic Ether.” “Almost all charms,” said an old writer, are impotent without words, because words are the speech of the writer and the *image of the thing signified or spoken of*. Therefore, whatever wonderful effect is intended, let the same be performed with the addition of words significative of the will or desire of the operator; for words are a kind of occult vehicle of the image conceived or begotten, and sent out of the body by the soul, therefore all the forcible power of the spirit ought to be breathed out with vehemency and an arduous and intent desire.” p. 115

The author, however, says:

“The real efficacy of Living Word is not in the actual sound or its pronunciation, but in the Imagination and Will of the individual who invokes. I do not want it to be meant that I attribute no potency at all to the words as combination of sounds,

such, for instance, as the sound 'Om.' Giving due allowance for the effect of the sound in itself, every thinker must come to the conclusion that in the Divine Power asleep within man lies the real force. Otherwise, how can identical results be produced by uttering different names." p. 119.

* * * *

"When the imagination is not vivid and the will is not powerful, then no amount of invocation of the Ineffable Name will produce the desired effect." p. 120

TANTRIK VIEW

We shall now cite what Tantra Shāstra has to say in the matter:

"Now, to-day many people, through ignorance of Shāstric principles, think that Mantra is the name of the words by which one expresses what one has to say to the supreme Divinity. It therefore follows that I may submit my prayer to Him in whatever language I choose. What, then, is the necessity of my using the ever-ancient words of the Shāstra? In reply to this we would at the very start point out that the definition which has been given to Mantra by those who hold this view is contrary to Shāstric principles, and consequently incorrect. In defining Mantra, Shāstra says: "That is called Mantra,¹ from Mañana or meditation of which arises the Universal special knowledge (that is, special knowledge embracing the whole universe) or realization of the Monistic truth that the substance of the Brahmānda² is not different from that of the Brahman. Man of Mantra comes from Manana which leads to Trāna, or liberation from the bondage of Sangsāra³ (tra of Mantra comes from trāna), and which calls forth (āmantrāna) Dharma, Artha, Kāma, and produces Moksha.⁴

1. Derived from the combination of man and tra.

2. Universe or "egg of Brahma".

3. The Sangsāra is the coming and going, the cycle of birth, action, death and rebirth; the world in which all live who have not by knowledge of the self (ātma-jñāna) and the extinction of the will to separate life attained liberation or moksha.

4. Literally, Svarūpa, of the Devatā. Svarūpa literally means "having its own form", as opposed to the existence or appearance of the same thing in another form.

“It is sheer ignorance to suppose that Mantra is mere language. Bījamantras, in particular, cannot possibly be language, for they convey no meaning according to the human use of language. They are the Devatā Herself,⁵ who is the highest spiritual object for us. They are neither language, nor words, nor letters,⁶ nor anything which you and I read or write but the Devatā who is eternally possessed of Siddhi, and is the Dhvani,⁷ which makes all letters sound, and exists in all that we may say or hear.” Principles of Tantra Part II by Arthur Avalon.

TANTRIK THEORY

Sir John Woodroffe, writing under the pseudonym Arthur Avalon, giving the Tantrik theory as to how Mantra acts, says in his ‘Studies in Mantra Shāstra,’ part IV, page 17 as follows:

“Artha is either subtle (Sūkhsma) or gross (Sthūla). The latter is the outer physical object which speech denotes and the former is the Vritti (modification) of the mind which corresponds to the gross Artha: for as an object is perceived the mind forms itself into a Vritti which is the exact mental counterpart of the object perceived. The mind has thus two aspects: in one of which it is the perceiver (Grāhaka) and in the other the perceived (Grāhya) in the shape of the mental impression. That aspect of the mind which cognises is called Shabda or Nāma (name) and that aspect in which it is its own object or cognised is called Artha or Rūpa (Form), Shabda being associated with all mental operations. In the evolution of the universe the undifferentiated Shabda divides itself into subtle Shabda and subtle Artha which then evolve into gross Shabda and gross Artha. For the cosmic Mind projects its subtle Artha on to the sensual plane which is then a physical gross Artha named in spoken speech. Thus the subtle shabda associated with cognition is called Mātrikā and the subtle Artha is the mental impression; whilst the gross Shabda are the uttered letters (Varna) denoting the gross outer physical object (Sthūla artha)”.

He says further in part III of the same work at page 8:

“Mantra is thus a pure thought-form; a pure Vritti or modification of the Antahkarana which is Devatā.”

5. Literally, Svarūpa, of the Devatā. Svarūpa literally means “having its own form”, as opposed to the existence or appearance of the same thing in another form.

6. Varna or Akshara.

7. Unlettered sound.

“Through Mantra the mind is divinely transformed. Contemplating, filled by, and identified with, Divinity in Mantra form, which is a Sthūla (gross) aspect of Devī, it passes into Her subtle (Sūkshma) Light form (Jyotirmayī Devī) which is the Consciousness beyond the world of Mayik-forms.”

“So the mind which thinks of the Divinity which it worships (Ishtadevatā) is at length, through continued devotion, transformed into the likeness of that Devatā. By allowing the Devatā thus to occupy the mind for long it becomes as pure as the Devatā. This is a fundamental principle of Tantrik Sādhanā or religious practice”. The serpent Power p. 88.

He says in section IV entitled “Mantra” in ‘The Serpent Power’ at p. 83 (Third Revised Edition):

“There is perhaps no subject in the Indian Shāstra which is less understood than Mantra. The subject is so important a part of the Tantra-Shāstra that its other title is Mantra-Shāstra. Commonly Orientalists and others describe Mantra as “prayer”, “formulæ of worship”, “mystic syllables”, and so forth. Mantra science may be well founded or not, but even in the latter case it is not the absurdity which some suppose it to be. Those who think so might except Mantras which are prayers, and the meaning of which they understand, for with prayer they are familiar. But such appreciation itself shows a lack of understanding. There is nothing necessarily holy or prayerful about a Mantra. Mantra is a power (Mantrashakti) which lends itself impartially to any use. A man may be injured or killed by Mantra.”

* * *

By Mantra in the initiation called Vedhadīkshā there is such a transference of power from the Guru to the disciple that the latter swoons under the impulse of it; by Mantra the Home fire may and, according to ideal conditions, should be lighted, by Mantra man is saved, and so forth. Mantra, in short, is a power (Shakti), power in the form of Sound.

Mantra is the manifested Shabdabrahman.”

According to Tantrashāstra, Sound (Shabda) is Dhwanyātmaka and Varnātmaka. First is caused by striking two things together and is meaningless; the second is Anāhata i. e. produced in the Heart Lotus. It is composed of letters, words and sentences and has a meaning. It is said to be eternal—not as audible sounds, but as that

which finds auditory expression in audible sounds. The Tantrikas follow Mīmāmsā doctrine of Shabda.

“In all cases it is the creative thought which ensouls the uttered sound in the form of Mantra.

Mantra and Devatā are one and the same. A Mantra—Devatā is Shabda and Artha, the former being the name, and the latter the Devatā whose name it is. By practice (Japa) with the Mantra the presence of the Devatā is invoked. Japa or repetition of Mantra is compared to the action of a man shaking a sleeper to wake him up. The two lips are Shiva and Shakti. Their movement is the coition (Maithuna) of the two. Shabda which issues therefrom is in the nature of Seed or Bindu. The Devatā thus produced is, as it were, the “son” of the Sādhaka. It is not the Supreme Devatā (for it is actionless) who appears, but in all cases an emanation produced by the Sādhaka for his benefit only. In the case of worshippers of Shiva a Boy-shiva (Bāla Shiva) appears, who is then made strong by the nurture which the Sādhaka gives to his creation. The occultist will understand all such symbolism to mean that the Devatā is a form of the consciousness of the Sādhaka which the latter arouses and strengthens, and gains good thereby. It is his consciousness which becomes the boy – Shiva, and when strengthened the full grown Divine power itself. All Mantras are in the body as forms of consciousness (Vijnāna-rūpa). When the Mantra is fully practised it enlivens the Samskāra, and the Artha appears to the mind.”

✓ The essence of all this is—concentrate and vitalise thought and will power. But for such a purpose a method is necessary—namely, language and determined varieties of practice according to the end sought. These, Mantravidyā (which explains what Mantra is) also enjoins.

We give below some further extracts relating to Mantra from Sir John Woodroffe's another work ‘Shakti and Shakta’:

“Telepathy is the transference of thought from a distance without the use of the ordinary sense organs. So in initiation the thought of a true Guru may pass to his disciple all his powers.” “What, however, is not understood in the West is the particular Thought Science which is Mantra Vidyā, or its basis. Much of the ‘New Thought’ lacks this philosophical basis which is supplied by Mantra Vidyā, resting itself on the Vedāntik doctrine.” p.237. “Mantra is thus a Shakti (Mantra Shakti) which lends itself impartially to any use. Mantra Vidyā is thus that form of Sādhanā by which union is had with the Mother Shakti in the Mantra form (Mantramayī) in Her Sthūla and Sūkshma aspects respectively. The Sādhaka passes from the first to the second (which is Light-Jyoti). This Sādhanā works through the letters, as other

forms of Sādhanā work through from in the shape of the Yantra,* Ghata or Pratiṁā.”

(“A Mantra is not the same thing as prayer‡ or self-dedication (Ātma-nivedana). Prayer is conveyed in what words the Sādhaka chooses. Any set of words or letters is not a Mantra. Only that Mantra in which the Devatā has revealed His or Her particular aspects can reveal that aspect, and is therefore the Mantra of that one of His or Her particular aspects. The relations of the letters (Varna), whether vowel or consonants, Nāda and Bindu, in a Mantra indicate the appearance of Devatā in different forms. Certain Vibhūti or aspects of the Devatā are inherent in certain Varna but perfect Shakti does not appear in any but a whole Mantra.”)

(Mantras are manifestations of Kulakundalinī.)

When, therefore, a Mantra is realised: when there is what is called in the Shāstra Mantra-Chaitanya, what happens is the union of the consciousness of the Sādhaka with that Consciousness which manifests in the form of the Mantra. It is this union which makes the Mantra “work”. “It is the union of Sound and idea through a knowledge of the Mantra and its meaning. The recitation of a Mantra without such knowledge is practically fruitless; except that devotion though ignorant is not wholly void of fruit.

WRITER'S VIEW

According to Sir John Woodroffe Indian magicians amongst others believe in the presence and aid of discarnate personalities (such as the unclean pishachas) given in the carrying out of occult operations. This is true, but it is not always the unclean pishachas who aid in the carrying out of occult operations. (Every Mantra is presided over, sacred to, or identified with a particular deity.) It is that deity generally and sometimes a member of his or her retinue acting under his or her order who carries out the occult operations.) Whenever a Mantrasiddha, who has been definitely promised aid by the deity of a particular Mantra, on the completion of the prescribed

*यन्त्रं मन्त्रमयं प्रोक्तं मन्त्रात्मा देवतैव हि

देहात्मनोर्यथा भेदो यन्त्रदेवतयोस्तथा ॥ —कौलावलीतन्त्रम् ॥

‡Some prayers however are called Mantras, as for instance the famous Gāyatrī Mantra.) This is because great importance is attached to the particular words comprised in it. The words in the exact form and order are believed to possess particular merit and efficacy. These are not therefore simply prayers but also Mantras.)

Puraṣcarana i. e. primary worship, desires to accomplish a particular thing and invokes the deity through the recital of his or her Mantra, the deity appears immediately and is seen by the Mantrasiddha and his desire is accomplished. Both the words of the particular Mantra and the Thought Force of the Mantrasiddha jointly perform the invocation* of the Deity and its consequent appearance. The achievement of the object desired by the Siddha—adept is by the Deity. So far as the first stage is concerned the words of the Mantra are the body of the deity and have the Deity as the soul. This soul remains only an image until vivified by the Thought Force of the Siddha bringing about the connection with the Deity. It is like an electrical installation connecting any place with the electric plant at the power-house and the Thought Force of the Siddha is the switch which turns on or off the current producing light. It cannot be, however, said that the words of the Mantra or for the matter of that, Thought Force of the Siddha directly brings about the material result.*

The Jains also believe in the existence of Vidyājṛmbhakas (विद्याजृम्भक) and Mantrajṛmbhakas (मंत्रजृम्भक) who aid men through Mantras and Vidyās. See Bhagavatī Sūtra VIII Śataka 14th. Uddes'a, p. 654—Āga-

(*Cf. "By practice with the Mantra the Devatā is invoked. This means that the mind itself is Devatā when unified with Devatā. This is attained through repetition of the Mantra (Japa).")

*Syādvāda—Ratnākara Pariccheda IV sūtra 7 pp. 632 ff:—

“येहि सत्यसंकल्पास्त एव मन्त्रानकर्तुं शक्नुवन्ति । ××× निरतिशयप्रभावसमन्वितैर्हि तैरमुष्मान्मन्त्रादस्येदं फलं भवत्वित्यनुसन्धाय यदा यथा कयाचिद्भाषया प्रयुज्यन्ते मन्त्रास्तदा तेषां तत्प्रभावादेव तथाविधार्थक्रियाकरणसामर्थ्यं सम्भाव्यते । दृश्यते हि साम्प्रतमपि महाप्रभावमन्त्रवादिन आज्ञाप्रदानान्निर्विषीकरणादिकम् । स चेत्थम्भूतः प्रभावो नेतरपुरुषाणां समस्ति । तेन न सर्वेषां मन्त्रकर्तृत्वम् । न च वाच्यं शब्दशक्तित एव निर्विषीकरणादिफलनिष्पत्तिर्न पुनः पुरुषशक्तिरिति । मुद्रामण्डलादीनां नैष्कल्येनाकरणप्रसङ्गात् । पुरुषाणां विध्यभिसन्धिविशेषानपेक्षित्वप्रसङ्गाच्च । पुरुषशक्तितः फलनिष्पत्तौ तु नायं दोषः । तेन हि यथा समयः कृतस्तत्र तथा समयानुपालनात्फलं निष्पद्यते । यां वा देवतामधिष्ठित्य मन्त्रः प्रणीतः सैव तत्समभिव्यापारसामर्थ्यात्समयमनुपालयन्तमनुगृह्णाति । राजादिवत् । ××× किञ्च समयाभिज्ञेनोच्चारितमेकैकमप्यक्षरं विषापहारादि कार्यं कुर्वदुपलभ्यते नेतरैः ॥”

modaya Samiti edition. It is not, however, shown whether this group of deities acts independently or under the orders of a superior deity. According to a Jain tradition contained in S'rī Haribhadrāsūri's commentary on Sri Āvas'yaka Sūtra the said deities gave Prajnapti and other secret Mahāvidyās to Nārada and Paṭavidyā to the famous Āchārya S'rī Vajraswāmi. One must presume that at their instance the Mantra deity helps the person favoured by them.

The question naturally arises then, what is the importance of the Thought-Force and the intrinsic force of the sounds or syllables comprising the Mantra. To answer this question, one has to bear in mind the fact that Mantravāda is principally Ādhidaivika-vāda i. e. subject dealing with deities although ultimately it may merge into Ādhyātmika-Vāda i. e. subject dealing with soul. In Ādhidaivika-vāda, Devatā is the central figure through whose grace the Sādhaka obtains everything desired by him. The Mantravāda however goes further and says that even Mokṣa is obtained through Mantra. But here it really merges into Ādhyātmika-vāda. A man whose soul-force is fully developed, a true Adhyātmavādi-a Yogi does not require the aid of any deity for performance of any occult operation. He is able to do so through his own power of meditation or what is usually called the soul-force. His thought-force is really his soul-force. In case of such persons, it can be said that without the aid of any particular Mantra, and without the aid of any deity whatsoever, through his own Soul Force, he can achieve anything he desires.* In terms of New Psychology he will be considered a person functioning on the highest plane.)

As regards the Sādhakas who have not risen so high, aid of deity is necessary and the occult operations of such Sādhakas are carried out with such aid.

Seeing how the Thought Force-Soul force ultimately is able to

*Some attain these powers through worship (Upāsana) of Patron Deity (Ishta-devatā). A higher state of development dispenses with all outer agents. See footnote 3, p. 97, The Serpent Power.

achieve everything, its importance is always to be kept in view. The Thought-Force of an ordinary Sādhaka combined with the sound-force of the Mantra *attracts* the deity of the Mantra towards him and makes him carry out his desires. Beyond requisitioning the presence and the aid of the deity of the Mantra, the thought-force of such a Sādhaka is not potent enough to achieve much. When his thought force is not working in unison with the sound—force of Mantra, it becomes powerless even to invoke the deity of the Mantra. The writer had the opportunity of consulting some persons versed in occult operations who informed him that if they forgot even one word or substituted through inadvertance another word in the original Mantra, the operation would fail or would have only nominal effect. It is suggested that the nominal effect noted to take place was really the result of the Māntrika's thought force. His Thought Force, however, not being assisted by the Sound-force of the Mantra (through the omission or substitution of a word of the Mantra) failed to invoke the presence of the Mantra deity and the operation therefore failed.

The usual plan in Mantravāda is to rouse the latent and dormant powers of the Sādhaka. He has to perform Sādhanā with the Mantra given to him by his preceptor and when that is done his powers are roused to a certain extent. To favour sometimes pupils incapable of performing sādhanā a preceptor prescribes a *Paṭhasiddha* Mantra (a Mantra whose inherent force is realized immediately on reading it) where no Sādhanā needs be performed. In this case it is the sound-force alone which invokes the presence of the Mantra deity. There are such cases noted in Jain scriptures. See the following verse in Vis'eṣāvas'yaka Bhāṣya of s'rī Jinabhadragani and its commentary given there:—

विज्ञाहर रायगिहे उप्पयपडणं च हीणदोसेण ।

कहणोसरणागमणं पयाणुसारिस्स दाणं च ॥८६४॥ पृ. ४११

It is narrated there that a Vidyādhara flying through the aid of a Vidyā came down and was unable to fly up straight again, he

having forgotten a syllable of the particular Mantra or Vidyā.* That shows the importance attached to the sound-force in Mantravāda. It cannot be said that the Vidyādhara using Vidyās daily must not have developed his Thought-Force but the Vidyā-deity would not act merely through his thought-force unaided by the sound force of the particular Vidyā.

We have stated above that when invoked the Mantra-deity appears before the Mantrasiddha and carries out the desired occult operation. This is so in most of the occult operations. There are some minor objects, such as cures of diseases etc., achieved through certain Mantras; and the writer has been informed that in such cases a deity does not appear before the operator, but carries out the desired objects unseen. It may be so or it may be the Thought force of the operator working with the Sound-force of the Mantra that effects the cure by its operation on the subconscious mind of the patient as is considered to be the case by modern psychologists in all faith-cures. It is difficult to give more detailed information on the subject, where the general tendency is to conceal and to keep to oneself what one knows, where people would not even acknowledge or admit their having acquaintance with Mantra. This is so because in many places people look down upon the Māntrikas owing to the evil practices of some of their class. This class is gradually becoming extinct and the tradition therefore is not handed down unbroken. It is hoped however that when the main features of occult operations performed through Mantras as here set forth become well known others would publish their experiences.

KUNDALINĪ SHAKTI YOGA

According to Sivasamhitā there are four kinds of Yoga: Man-

* Cf. मन्त्रो हीनः स्वरतो वर्णतो वा मिथ्याप्रयुक्तो न तमर्थमाह ।
स वाग्वाग्ने यजमानं हिनस्ति यथेन्द्रवाग्नुः स्वरतोऽपराधात् ॥

trayoga, Hathayoga, Layayoga and Rājyoga.* Yoga through the rousing of Kundalinī Shakti is Laya yoga. It means the piercing by the kundalinī shakti of the six bodily centres or chakras (also called Padmas-lotuses).

Yoga means that process by which the human spirit (Jīvātmā) is brought into near and constant communion with, or is merged in, the Divine Spirit (Paramātmā) according as the nature of the human spirit is held to be separate from (Dvaita, Vis'iṣṭādvaita) or one with (Advaita) the Divine spirit. As Shaktas are Advaitavādins, according to them, identity of the two (Jīvatmā and Paramātmā) is realised by the Yogi.)

According to the Jains, it is the process by which the Self—the human spirit realises its own real pure nature (svabhāva).† Although the Jains believe in multiplicity of souls—all intrinsically pure and equally powerful as far as Yoga of each soul individually is concerned, they might be considered to be practically Advaitavādins. As each individual soul in its ultimate nature (Siddha-Muktasvarūpa) is of the nature of the Perfect soul (Paramātmā svarūpa) and nothing less, in their case the soul realizing and the soul realized are one and the same.× The latter is called Paramātmā because it is the highest and purest aspect (Paramasvarūpa) of the Jīvatmā.

In short, in their case the Jīvatmā is joined to its own Paramātmā-svarūpa that is to say, it realizes its own pure nature devoid of all karmas.

* मन्त्रयोगो हठश्चैव लययोगस्तृतीयकः ।

चतुर्थो राजयोगः स्यात्स द्विधाभाव वर्जितः ॥ शिवसंहिता, पटल ५ श्लो. १४

† चतुर्वर्गेऽग्रणीर्मोक्षो योगस्तस्य च कारणम् । ज्ञानभ्रदानचारित्ररूपं रत्नत्रयं च सः ॥ योगप्रकाशः १, १५
अध्यात्मं भावना ध्यानं समता वृत्तिसंक्षयः ।

मोक्षेण योजनाद्योग एष श्रेष्ठो यथोत्तरम् ॥ योगबिंदु श्लो. ३१

× परमात्मसमापत्तिर्जीवात्मनि हि युज्यते ।

अभेदेन तथा ध्यानादन्तरङ्गस्वशक्तितः ॥ द्वात्रिंशद् द्वात्रिंशिका, योगावतार द्वा. श्लो. १६

KUNDALINĪ SHABDA BRAHMAN

(The relevance of this discussion will be seen from the fact that all Mantras are supposed to be manifestations of Kula Kundalinī which is a name for the Shabda Brahman or Saguna-brahman in individual bodies.* Kundalinī believed to be in the Mūlādhāra Chakra (or basal bodily centre) is “the cause of sweet, indistinct, and murmuring Dhvani, which is compared to the humming of a black bee. Thence Shabda originates and being first Parā gradually manifests upwards as Pashyantī, Madhyamā, and Vaikharī, (the spoken speech). The substance of all Mantras, being manifestation of Kundalinī, is consciousness (chit) manifesting as letters and words. The letters of the alphabet are called Akṣara because they are the diagrammatic representation-Yantra of the Akṣara or Imperishable Brahman. This is realized, however, when the Sādhaka’s shakti generated by Sādhanā is united with Mantra Shakti. The different aspects of Devatās as presiding deities of Mantras are the manifestation of the gross (sthūla) form of Kundalinī, × who is however extremely subtle. “Mantra and Devatā are thus one and particular forms of Brahman as Shiva-Shakti.”)

NĀDA-BINDU-KALĀ

सच्चिदानंदविभवात् सकलात् परमेश्वरात् ।

आसीच्छक्तिस्ततौ नादो नादाद् बिन्दुसमुद्भवः ॥

—शारदातिलकम्, प्रथमः पटलः, श्लो. ७ पृष्ठ ९

From the Sakala Parameshvara who is produced from Saccidānanda issued Shakti; from Shakti came Nāda; and from Nāda issued Bindu, the latter being perfected out of Ardha-chandra issuing out of Nāda becoming slightly operative towards “speakable” (Vāchya). The Bindu

* चैतन्यं सर्वभूतानां शब्दब्रह्मेति मे मतिः ॥१३॥

तत्प्राप्य कुण्डलीरूपं प्राणिनां देहमध्यगम् ।

वर्णात्मनाऽऽनिर्भवति गद्यपद्यादिभेदतः ॥१४॥

—शारदातिलकम्, प्रथमः पटलः पृ. १२

× Śri Bappahhatti. Sūri is the first Jain Ācharya to mention Kundalinī. See Appendix 12 V. 1

becomes threefold as the Kāmakalā, * or creative will. This triangle of Divine Desire Kāmakalā is personified as the Great Devī Tripura-sundarī.

SIX CHAKRAS

“Out of the six bodily chakras five lower ones are situated within the spine in the cord—a compound of grey and white brain matter. Mūlādhāra is the lowest in *filum termanale* in a position midway in the perineum between the root of the genitals and the anus. Proceeding upwards controlling genitals is the Svādhishthāna, controlling the navel region—abdomen Manipūra, controlling the heart Anāhata and controlling the throat—larynx Viśuddha. Between the eyebrows is Ājnā the sixth Chakra. Above them all in the cerebrum is Sahasrāra a thousand-petalled lotus, the highest centre of manifestation of Consciousness in the body.

These six Chakras or lotuses have respectively four, six, ten, twelve, sixteen and two petals which are configurations made by the position of Yoga-Nādis at any particular centre. These Nādis are not those known to the Vaidyas of medical shāstras but subtle channels (Vivara) along which the Pranik currents flow. The letters of the Sanskrit alphabet numbering 50 (excluding second La) are in the petals of the six Chakras which also together number 50. ह (Ha) and क्ष (Kṣa) are in the two petals of Ājnā Chakra, the Sixteen स्वर (vowels) in the sixteen petals of Viśuddha; the 12 consonants क (Ka) to ठ (Ṭha) in the twelve petals of Anāhata, the 10 consonants ढ (Ḍa) to फ (Fa) in the ten petals of Manipūra, the six consonants ब (Ba) to ल (La) in the six petals of Svādhishthāna, and the remaining four consonants व (Va) to स (Sa) in the four petals of Mūlādhāra. “The six Chakras have their correspondences in physical body in the following nerve plexuses commencing from the lowest the Mūlādhāra:—The Sacrococcygeal plexus, the Sacral plexus, the Solar plexus (which forms the great junction of the right and left sympathetic chains Idā and Pingalā) with the cerebro-spinal axis. Connected with this is the Lumbar plexus. Then follows the Cardiac plexus (Anāhata) Laryngeal plexus and lastly the Ājnā or cerebellum identified by some with the pineal Gland, the centre of the third or spiritual eye) with its two lobes and above this the Manas Chakra or sensorium with its six lobes, the Soma chakra or middle Cerebrum and lastly the Sahasrāra or upper Cerebrum. To some extent these localizations are yet tentative. The six Chakras themselves are vital centres of consciousness really within the spinal column in the white and grey matter there.” Shakti and Shakta p. 410)

* नादबिन्दुकलाभ्यासाज्ज्योतिरुत्पद्यते पुनः ।
तत्प्राप्तौ च मनुष्याणां जायते परमं पदम् ॥ श्री चिन्तामणिकल्पः ॥

We do not propose to enter into a detailed description of these six Chakras here. We would refer the readers interested therein to the scholarly work "The Serpent Power" by Arthur Avalon. Dr. Rele's 'The Mysterious Kundalinī and (C. W. Leadbeater's 'The Chakras') may also be referred to. Dr. Rale's identification of Kundalinī, however, with 'Right Vagus Nerve' cannot be approved of.

(Some books mention Lalanā Manas and Soma Chakras and others many more. But the chief ones are the said six Chakras. Sixteen Ādharas are also mentioned as suitable points for concentration. In the spine the central Nādi is termed Sushumnā Nādi. On each side, respectively called Idā and Pingalā, are the left and right sympathetic cords. Crossing the central column from one side to the other they make with the Sushumnā a threefold knot called Trivenī* which is the spot in the Medulla where the sympathetic cords join together and whence they take their origin.)

SHATCHAKRA-VEDHA

Sir John Woodroffe in his work 'Shakti and Shakta' has aptly described how Kundalinī pierces the six centres—Chakras. We would therefore quote the relevant portion abridging the same.

(“Shakti when manifesting divides itself into two polar aspects — Static and dynamic—which implies that you cannot have it in a dynamic form without at the same time having it in a static form, much like the poles of a magnet. In any given sphere of activity of force you must have according to the cosmic principle a static back-ground Shakti *at rest* or 'coiled' as the Tantras say. In the living body there is, therefore, the same polarisation. *** Shakti is never exhausted, that is, emptied into any of its forms. In the body Kundalī is the static centre and round this centre the whole of the bodily forces move. The body may, therefore, be compared to a magnet with two poles. The Mūlādhāra, in so far as it is the seat of Kundalī Shakti, a comparatively gross form of Chit (being Chit—Shakti and Māya—Shakti) is the static pole in relation to the rest of the body which is dynamic”.)

* This knot is called Rudragranthi. There are other two: Brahmagranthi in the Mūlādhāra Chakra and Viṣnugranthi in the Anāhata Chakra. The force of Māyā Shakti is greater at this knots.)

"By Prānāyāma and other Yogik processes this static Shakti-Kundalinī becomes dynamic.* When completely dynamic, that is, when Kundalī unites with Shiva in the Sahasrāra the polarisation of the body gives way. The two poles are united in one and there is the state of consciousness called Samādhi (Ecstasy). This unity of two poles is in relation to consciousness only. The body actually exists continuing its organic life; but man's consciousness of his body and all other objects is withdrawn because the mind has ceased to function as far as his consciousness is concerned. Then the question arises how is the body sustained. The Tantriks say it is sustained by Amṛta—the nectar which flows from the union of Kundalinī shakti with Shiva in the Sahasrāra. This nectar is an ejection of power generated by their union." Sir John Woodroffe cites the opinion of his friend Professor Pramathanātha Mukhopādhyāya: "the potential Kundalī Shakti becomes kinetic shakti; and yet since shakti—even as given in the Mūla centre is an infinitude, it is not depleted; the potential store always remaining unexhausted. In this case the dynamic equivalent is a partial conversion of one mode of energy into another. If, however, the coiled power at the Mūla became absolutely uncoiled there would result the dissolution of the three bodies gross, subtle and causal, and consequently Videha-Mukti, because the static background in relation to a particular form of existence would, according to this hypothesis, have wholly given way."

"As the Shakti ascends the body becomes cold. It is not due to the depletion of the static power at the Mūlādhāra but to the concentration or convergence of the dynamic power—the Prāna which is ordinarily diffused over the whole body. In Yoga it is converged along the axis (Merudanda), the static equivalent of Kundalinī-shakti enduring in both cases. Some part of the already available dynamic Prāna is made to act at the base of the axis in a suitable manner by which means the basal centre or Mūlādhāra becomes, as it were, over saturated and re-acts on the whole diffused dynamic power (or Prāna) of the body by withdrawing it from the tissues and converging it along the line of the axis. In this way the diffused dynamic equivalent becomes the converged dynamic equivalent along the axis. What, according to this view, ascends, is not the whole Shakti but an eject like condensed lightning, which at length reaches the Parama-Shivasthāna. There the individual consciousness is merged into the supreme consciousness, the limited consciousness transcending directly intuits the Reality. When Kundalī Shakti *sleeps* in the Mūlādhāra, man is *awake* to the world. When she *awakes* and unites with the supreme static Consciousness he is *asleep* to the world and is one with the Light of all things."

*Kundalinī is roused by Tapas i. e, Prānāyāma and Mantra. 'Hūm Hamsah' is the actual Mantra used for the purpose. Generally speaking Panchadashi Mantra is regarded as the most appropriate. 'Hamsah' is the Ajapa Gāyatrī Mantra.)

“The main principle appears to be that when ‘wakened’ Kundalī Shakti either Herself or in Her eject ceases to be a static power sustaining the word consciousness, and when once set in movement is drawn to that other static centre in the thousand-petalled Lotus (Sahasrāra) which is Herself in union with the Shiva consciousness or the consciousness of ecstasy beyond the world of forms.” ✓

It may be noted here that Gāyatrī Sādhanā is in the highest Chakra viz. Ājnā only and that followers of Samayāchāra do not worship in any of the Chakras below Anāhata.)

SAMĀDHI

Practitioners of this Yoga claim that it is higher than any other and that the Samādhi (ecstasy) attained thereby is more perfect. The Samādhi of Laya-Yoga however is said to be Savikalpa samādhi. and that of Rāja-Yoga Nirvikalpa samādhi.)

“In Mantrayoga worship and devotion predominate. In the Samādhi of Mantrayoga the state of ‘Mahābhāva’ is attained marked by immobility and speechlessness.” In Hathayoga, contemplation is on the Light:

भ्रुवोर्मध्ये मन ऊर्ध्वं यत्तेजः प्रणवात्मकम् ।

ध्यायेज्ज्वालावलीयुक्तं तेजोध्यानं तदेव हि ॥ Gheranda Samhitā, VI Upades'a v. 17

In Hathayoga the Samādhi called ‘Mahābodha’ is attained; respiration ceases and the yogi is without sign of animation. In Layayoga the Samādhi called ‘Mahālaya’ is attained; there is no outer consciousness but the yogi is immersed in the Ocean of Bliss. In Rājayoga ‘Nirvikalpa Samādhi’ is attained; there is Nirvikalpa Chit-Svarūpa-bhāva and ultimately Liberation. There are four states of detachment (Vairāgya) from the world corresponding to the four yogas. Mantra, Hatha, Laya and Rāja; they are Mridu (Weak or intermittent) Madhyama, (Middling), Adhimātra (of high degree) and Para (Highest).)

MUKTI

Not only the Mantrayogi but also the Hathayogi avails himself of this kundalīyoga for Liberation. Then remains the Rājayoga or Jñānayoga which yoga is termed Dhyānayoga.)

There are thus two main lines of yoga, namely Dhyāna or Bhāvanāyoga and kundalī yoga. The Jains favour Rājayoga–Bhāvanāyoga*. In Dhyāna yoga Samādhi is attained through detachment from the world and meditation leading to cessation of all the mental activities or the uprising of pure Consciousness unhindered by the limitations of the mind. This meditation is sometimes aided by auxiliary processes of Mantra or Hatha yoga (other than the rousing of Kundalī shakti). The degree to which this unveiling of consciousness is effected depends upon the meditative powers (Jnāna Shakti) of the Sādhaka, and the extent of his detachment from the world. In it there is no rousing and union of kundalī shakti with the accompanying bliss and acquisition of special powers (Siddhi). In both Yogas bodily consciousness is lost but there being no union of the central bodily power with the supreme consciousness the Dhyānayogi does not possess the particular kind of enjoyment (Bhukti). There is a difference between the Bhukti of the Divyayogi and the Vīrasādhaka, the latter has only a reflection of the bliss on the physical plane—a welling up of the true Bliss through the deadening coverings and trammels of matter. The so called Mukti of the Vīra-sādhaka is only figurative. It is the Divya-yogi who has both Bhukti and Mukti.)

TANTRAS

WESTERN WRITER'S IGNORANCE.

There has been much mis-understanding created by Western writers about Tantra. To them it was a jumble of black magic and erotic mysticism cemented together by a ritual which is meaningless mummary. Sir John Woodroffe says:

“A large number of these writers who talk in this strain have never had a Tantra in their hands and such Orientalists as have read some portions of these

* प्राणायामक्रमप्रौढिरत्र रुढयैव दर्शिता ।

क्षपकस्य यतः श्रेण्यारोहे भावो हि कारणम् ॥५९॥ गुणस्थानक्रमारोहः

scriptures have not generally understood them, otherwise they would not have found them to be so "meaningless". They may be bad or they may be good but they have a meaning. Men are not such fools as to believe in what is meaningless. To them perhaps it had no meaning. For otherwise they would not define Mantra as "mystical words"; Mudra as "mystical gestures" and Yantra as "mystical diagrams".)

It does not imply knowledge. Those who speak of 'mummery', 'gibberish', and 'superstition' betray both their incapacity and ignorance.

NECESSITY FOR PRACTICAL METHOD IN RELIGION

Religion is a practical activity; just as the body requires exercise training and gymnastic, so does the mind. This may be of a merely intellectual or spiritual kind (The means employed are called Sādhanā which comes from the root "Sādh" to exert. Sādhanā is that which leads to Siddhi.) Some practical ritualistic Method is necessary for realisation if religion is not to be barren of result. Tantra Shāstra gives that practical method. The mere statement of religious truths is not sufficient. What is necessary is a practical method of realisation. Further ordinary people cannot apprehend nor can they derive satisfaction from mere metaphysical concepts. For them ritualistic methods of self realisation are useful. These people are impressed if one can appeal to the personal principle. Be it Devī or Deva, Shiva or Vishnu, or Buddha or Jina, or for the matter of that any other deity. Further these people require guidance of a preceptor. It is not enough for them to meditate and to uplift their mind in homage to the supreme deity. They need a definite representation of their object of worship as is detailed in the Dhyāna of the Devatās or in their image or Yantra. A ritualistic and pictorial religion can hold their attention.)

RITUAL AND ITS UTILITY

(Ritual is an art, the art of religion.) Art is the outward material expression of ideas intellectually held and emotionally felt (Ritual art is concerned with the expression of those ideas and feeling which are specifically called religious.) It is a mode by which religious truth is presented, and made intelligible in material forms and symbols to the mind. It appeals to all natures passionately sensible of that

Beauty in which, to some, God most manifests Himself. But it is more than this. For it is the means by which the mind is transformed and purified. In particular according to Indian principles it is the instrument whereby the consciousness of the worshipper (Sādhaka) is shaped in actual fact into forms of experience which embody the truths which Scripture teaches.”)

It is true that in course of time all these tendencies become accentuated and superstition, mechanical devotion, lifeless formalism and other abuses result. Buddhism in its origin has been a reaction against excessive and barren ritualism yet it could not rest with a mere statement of truths and the eight-fold path. Something practical was needed. The Mahāyāna was produced. (Nāgārjuna in the second century A. D. is said to have promulgated ideas to be found in the Tantras.) Theistic notions as also Yoga came to be adopted in the Buddhist systems. The worship of the Shaktis spread. The Buddhist Mantrayāna and Vajrayāna found acceptance. Thus Tantrik Buddhism became fully developed.

ATTITUDE OF ENGLISH-EDUCATED INDIANS

(Tantra Shāstra governs the household and temple ritual of every Hindu. Sir John Woodroffe asks how is it that such a Shāstra has fallen into complete neglect and disrepute amongst the larger body of the English-educated community. And he answers:— “ In the first place the English-educated people of this country were formerly almost exclusively, and later to a considerable extent, under the entire sway of their English educators. In fact they were in a sense their creation. They were, and some of them still are, the Mānasaputra of the English. For them what was English and Western was the mode. Hindu religion, philosophy and art were only, it was supposed, for the so-called “uneducated” women and peasants and for native Pandits who, though learned in their futile way, had not received the illuminating advantages of a western training.” “ Their mind has been so dominated and moulded to a Western manner of thinking (philosophical, religious, artistic, social and political) that they have scarcely any greater capacity to appreciate their own cultural inheri-

ance than their teachers, be that capacity in any particular case more or less. Some of them care nothing for their Shāstra. Others do not understand it. × × × The Indian who has lost his Indian soul must regain it if he would retain that independence in his thought and in the ordering of his life which is the mark of a man, that is of one who seeks Svarājyasiddhi.

“Again the cause of this ignorance is the fact that the Tantra Shāstra is a Sādhana Shāstra, the greater part of which becomes intelligible only by Sādhanā.”

IMPARTIAL CRITICISM OF TANTRAS

An impartial criticism of Tantras may be summed up in the few words that together with what has value, it contains some practices which are not approved and which have led to abuse (for these see post).

TANTRAS THEIR CONTENTS AND CHARACTERISTICS

We have mentioned in the beginning that “Śrī Bhairava Padmāvati Kalpa”, the work here published, is a Tantra. We would, therefore, consider the characteristics and contents of Tantras. We do not propose to enter into a learned discussion about the etymology of the word ‘Tantra’. Readers interested in such discussion will find it in the beginning of chapter II of ‘Shakti and Shakta’ by Sir John Woodroffe. According to the said chapter (Tantra means a particular kind of religious scripture. Kāmika Āgama there quoted gives the following definition:—

तनेति विपुलानर्थान् तत्त्वमन्त्रसमन्वितान् ।
त्राणं च कुहते यस्मात् तन्त्रमित्यभिधीयते ॥

“ It is called Tantra because it promulgates great knowledge concerning Tattva and Mantra and because it saves. ”

CONTENTS

“ The Tantra deals with all matters of common belief and interest from the doctrine of the origin of the world to the laws which govern kings and societies which they have been divinely appointed to rule, medicine and science generally. The Tantra is not

only the basis of popular Hindu practice, on which account it is known as the Sādhana-Śāstra, but is the repository of esoteric belief and practices, particularly those relating to Yoga and mantra-tattva. Indeed, as regards the last which is one of the most peculiar, and at the same time, most profound aspects of Hindu teaching, the Tantra is to such an extent the acknowledged repository of this spiritual science that its other name is the mantra-shāstra. Its claims to such a name could not have been made good were there not some ground for its assertion that it is a yoga-shāstra for the Kāli age. As to which Tantras, however, are authoritative there appear to be differences of opinion, such differences being due either to a mistaken Sectarianism, or possibly to real divergences as regards doctrinal thought and historical descent.

“Thus the Tantras are concerned not only with worship, spiritual doctrines and popular Hindu practices Religious, Māntrik or Yaugik, but also Science, Law, Medicine and a variety of other subjects. Indian Chemistry and Medicine in particular are largely indebted to the Tantras.”

“In short, it is considered an error to regard the Tantra as the petty śāstra of any religious sect only, and a still greater mistake to limit its operation to that which is but one only of its particular methods or divisions of worshippers.”
Principles of Tantra, Introduction, P. XXIX.

These Tantras are otherwise known as Āgamas. It is a common misconception that Tantra is the name of the Scripture of the Shāktas or worshippers of Shakti. This is not so. There are Tantras of other sects also. Tantras of Shaivas, Vaishnavas, Sauras and Gānapatyas.

Sir John Woodroffe says that even the Jains and Bauddhas have their own Tantras (See Shakti and Shakta p. 78). Similarly in Shakti-Sangama-Tantra, Kāli-Khanda, 8th Patala (See p. 92 vv. 12 to 14) Jains also are classed among the Tāntrikas.

SCHOOLS AND DIVISIONS

There are various divisions and sub-divisions of these Āgamas such as Vaidic and Non-Vaidic. Then again the Āgamas are divided according as the Ishtadevatā worshipped is: Shakti, Shiva, Vishnu,

Sūrya or Ganapati. The large extent of Tantra literature can be seen from the fact that “ the Sammohana Tantra (Chapter VI) mentions 64 Tantras, 327 Upatantras as also Yāmalas, Dāmaras, Samhitās and other Scriptures of the Shākta class; 32 Tantras, 125 Upatantras, as also Yāmalas, Dāmaras, Purānas and other Scriptures of the Shaiva class; 75 Tantras, 205 Upatantras, as also Yāmalas, Dāmaras, Samhitās of the Vaishnava class; numerous tantras and other scriptures of the Gānapatya and Saura classes, and a number of Purānas, Upapurānas and other variously named Scriptures of the Bauddha class. It then (chapter VII) mentions over 500 Tantras and nearly the same amount of Upatantras, of some 22 Āgamas, Chināgamas (see chapter IV post) Bauddhāgama, Jaina, Pāshupata, Kāpālika, Pancharātra, Bhairava and others. There is thus a vast mass of Tantras in the Āgamas belonging to differing schools of doctrine and practice.”² The characteristics of Āgama are summed up as follows:

सृष्टिश्च प्रलयश्चैव देवतानां तथार्चनम् ।

साधनं चैव सर्वेषां पुरश्चरणमेव च ॥ ✓

षट्कर्मसाधनं चैव ध्यानयोगश्चतुर्विधः ।

सप्तभिर्लक्षणै युक्तमागमं तद्विदुर्बुधाः ॥ —वाराहीतंत्रे आगमलक्षणम्

COMMON CHARACTERISTICS

In all these, however, it will be found on an examination that there are the same general ideas, characteristics and practices. There is emphasis on devotion (Bhakti), provision for all castes and both sexes. “Instances of common practices are for example Mantra, Bīja, Yantra, Mudrā, Nyāsa, Bhūtaśuddhi, Kundalīyoga construction and consecration of temples and images (Kriyā) religious and social observations (Charyā) such as Āhnikā, Varnāśramadharmā, Utsava; and practical magic (māyāyoga).” “To my mind, one of the most distinctive marks of the Tāntrik system is its profound application of psychology to worship, and the manner in which it not only teaches through symbols, but actually *creates*, through its ritual methods, the states of mind which are set forth as the end of its teachings.”³ P. XVI Introduction to Shri Chakra Sambhāra.

(Where there is Mantra, Yantra, Nyāsa, Dīksha, Guru, and the like there is Tantra Shāstra. In fact one of the names of the latter is Mantra Shāstra. With these similarities there are certain variations of doctrine and practice between the different schools.")

(There is only one important matter in which there is difference worth noting i. e. division of the practices of the worshippers into Dakshināchāra and Vāmāchara. The secret Sādhanā of some of the latter has acquired such notoriety that to some 'Tantra' connotes this particular worship and its abuses and nothing else. One cannot, however, identify Tantra with the particular practices of a section of worshippers only.)

SIX AMNĀYAS AND FOUR SAMPRADĀYAS

Tantras mention six Amnāyas which are in order of their origin revealed by the six faces of Shiva looking East (Pūrvāmnāya), South (Dakshināmnāya), West (Paschimāmnāya), North (Uttarāmnāya) the Upper (Ūrdhvāmnāya) and the Lower and concealed (Adhāmnāya) According to the Devyāgama (1) The Eastern face revealed Shrī Bhuvaneshvari, Tripurā, Lalitā, Padmā, Shūlinī, Sarasvatī, Tvaritā, Nityā, Vajraprastārinī, Annapūrnā, Mahālakshmi, Lakshmi, Vāgvādinī with all their rites and Mantras. (2) The Southern face revealed Prasādasadāshiva, Dakshināmūrti, Batuka, Manjughosha, Bhairava, Mritasanjīvanīvidyā and Mrityunjaya with all their rites and Mantras. (3) The Western face revealed Vāsudeva, Vishnu, Rāmchandra, Ganesha, Agni, Sūrya, Vidhu (Chandra), Dikpālas, Hanumān and others their rites and Mantras. (4) The Northern face revealed Devīs Dakshinākālikā, Mahākālī, Guhyakālī, Smashānakālikā, Bhadrakālī, Ekajatā ugratārā, Tārini, Kātyāyanī, Chhinnamastā, Nilasarasvatī, Durgā, Jayadurgā, Navadurgā, Vashuli, Dhūmavati, Vishalākshī, Gaurī, Bagalāmukhī, Pratyangirā, Mātangi Mahishamardinī, their rites and Mantras. (5) The upper face revealed Tripurasundarī, Tripureshī, Bhairavī, Tripurabhairavī, Smashānabhairavī, Bhuvaneshībhairavī, Shatkutabhairavī, Annapūrnābhairavī, Panchamī, Shodashī, Mālinī, Balābalā with

their rites and Mantras. (6) The lower face revealed Devatāsthāna, Āsana, Yantra, Mālā, Naivedya, Balidāna, Sādhanā, Purashcharana and Mantrasiddhi. It is called Īshānāmnāya.

According to Niruttara Tantra the Pūrvāmnāya and Dakshināmnāya rites are for Pashu sādhakas. The Pashchimāmnāya is for Pashu and Vīra, the Uttrarāmnāya is for Vīra and Divya and the Ūrdhvāmnāya is for Divya. There are four Sampradāyas amongst the Shāktas viz. Kerala, Kāshmira Gauda and Vilāsa. In each of these there are Pad-dhatis such as Shuddha, Gupta and Ugra. There is variance of De-
vatās and rituals. The connection between these Sampradāyas and Āmnāyas is shown in the following verse.

ऊर्ध्वान्नायः केरलः स्यात् काश्मीरः पश्चिमो भवेत् ॥ ६७ ॥

विलासाख्यो वैष्णवाख्यो दक्षिणान्नाय एव च ।

पूर्वे चैतन्य आख्यातस्तूतरे गौड एव च ॥ ६८ ॥

—शक्तिसंगमतन्त्रे कालीखण्डे चतुर्थः पटलः पृ. ४६

THREE KRĀNTAS

There are again three Krāntas—geographical divisions of India viz, Vishnu Krānta, Ratha Krānta and As'va Krānta being respectively the North-Eastern, North-Western and Southern divisions of India each of which has a separate set of 64 Tantras.

THREE MATAS

There are three main Matas viz, Kādi, Hādi and Kahādi. The first has Kālī as the Devatā, the second Tripurasundarī and the third Tārā i. e. Nīlasarasvatī, Gauda Sampradāya considers Kādi the highest Mata, whilst Kāshmira and Kerala worship Tripurā and Tārā. Out of 56 Deshas 18 follow Gauda extending from Nepala to Kalinga and 19 follow Kerala extending from Vindhyāchala to the Southern sea and the remaining Deshas Kāshmira Sampradāya.

SEVEN TĀNTRIK ĀCHĀRAS

According to Kulārnavā Tantra there are seven Āchāras viz, Veda, Vaishnava, Shaiva, Dakshina, Vāma, Siddhānta and Kaula. The first four are considered Pashvāchāra. In the fifth and the sixth, a gra-

dual approach is made to the seventh considered the highest. The main divisions of Āchāra however are Vedāchāra, Dakshināchāra and Vāmāchāra. Vedāchāra is not Vaidikāchāra. The latter is outside the sevenfold Tāntrik division of Āchāra. Tāntrik Vedāchāra is Tāntrik Upāsana with Vaidik rites and Mantras with Agni as Devatā, Vedāchāra is the lowest and Kaulāchāra as stated above the highest. According to Vishvasāra Tantra in Vedāchāra the Sādhaka should not worship the Deva at night and should be celibate except in the period following the courses of the wife, and should not eat meat and fish on the Parva days. Vaishnavāchāra is much stricter. Complete celibacy and Ahimsā (non-killing) are to be observed. It is marked by worship of Vishnu Tapascharyā and contemplation of the Supreme. Shaivāchāra is Vedāchāra with the difference that Ahimsā is to be observed and meditation is on Shiva. Dakshināchāra is so called because of Rishi Dakshināmūrti who is said to have practised it. This is preparatory for the Vīra and Divya Bhāvas. Meditation is on the supreme Ishvarī after taking Vijayā (Bhāng). Japa of Mantra is done at night. Siddhi is attained by using a rosary of human bone (Mahāshangkha) at certain places including a Shaktipītha. Dakshināchāra does not mean “right hand worship” but is the Āchāra favourable for the worship of Dakshinā Kālikā who is a Devī of the Uttara Āmnāya. Approach is here made to Vīra rituals. The Sādhaka here starts on Nivrittimārga, worships not merely an aspect of Deva but Deva-whole i.e. Ādyāshakti in whom are united the three Shaktis of Brahman viz, Icchā, Kriyā and Jnāna. Vāmāchāra also does not mean “Left-hand worship”. It is so called because it is adverse to the popular Pravrittīmārga or because Vāmā (woman) enters into the Āchāra. What is commenced here is completed in Siddhāntāchāra and Kaulāchāra. Kaulas are aptly described in the following verse.

अन्तः शक्ता बहिः शैवाः सभायां वैष्णवा मताः ।

नामरूपधराः कौला विचरन्ति महीतले ॥

“At heart a Shākta, outwardly a Shaiva, in gatherings a Vaishnava—in thus many a guise the Kaulas wander on earth.”)

ANTIQUITY OF TANTRAS

On the antiquity of the Tantra literature, Sir John Woodroffe, in his introduction to Principles of Tantra, says as follows:—

“Whatever be the date of the first appearance of specifically Tantric doctrines, which, owing to the progressive nature of its developments, may never be ascertained, it will be probably found, upon a profounder inquiry into the subject than has been hitherto made, that the antiquity of the Tantra has been much underestimated. This however, does not mean that all the current Tantras, or all their contents, are of great antiquity. Comparatively modern Tantras may, however, be based on older versions now lost.

“The following remarks of Professor Hayman Wilson have a bearing on this point, both on the general question of the antiquity of the Hindu śāstras and that of the Tantra, if, as is commonly done, the date of the latter is to be fixed with reference to the alleged date of the Paurānic period, which, according to general European views precedes them. ‘It is’, therefore, ‘as idle as it is irrational to dispute the antiquity or authenticity of the great portion of the contents of the Purānas in the face of abundant positive and circumstantial evidence of the prevalence of the doctrines which they teach, the currency of the legends which they narrate, and the integrity of the institutions which they describe at least three centuries before the Christian Era. But the origin and development of these doctrines, traditions and institutions were not the work of a day, and the testimony which establishes their existence three centuries before Christianity carries it back to a much more remote antiquity—to an antiquity that is probably not surpassed by any of the prevailing fictions, institutions, or beliefs of the ancient world’.

Sir John Woodroffe has also given expression to a generally accepted view according to which “the Āgamas did not come into being earlier than a date later than the first and chief Upanishads and perhaps at the close of what is generally called the Aupnishadik age.”

The Purānas are replete with Tāntrik rituals and Sādhanā. Agni Purāna contains worship of several Tāntrik deities and shows that the Tāntrik worship had made considerable progress and was developed to an extent. Shiva Purāna V Samhitā, L Adhyāya V. 28–29 actually names the ten Mahāvidyās as emanating from Durgā. The general opinion therefore above cited gives a correct indication of the age of Tantras.

VALUE OF TANTRA

Speaking about the intrinsic value of Tantra Shāstra Sir John

Woodroffe at page 41 of "Shakti and Shakta" 2nd edition, says:

"Thus it (Tantra Shāstra) is the storehouse of Indian occultism. This occult side of the Tantras is of scientific importance, the more particularly having regard to the present revived interest in occultist study in the West. "New thought" as it is called and kindred movements are a form of Mantravidyā. Vashīkaranam is hypnotism, fascination. There is "Spiritualism" and "Powers" in the Tantras and so forth. For myself, however, the philosophical and religious aspect of the Scripture is more important still. The Main question for the generality of men is not Power (Siddhi). Indeed the study of occultism and its practice has its dangers; and the pursuit of these powers is considered an obstacle to the attainment of that true Siddhi which is the end of every Shāstra."

Sir John Woodroffe says further that although worship of Shakti is in some of its essential features very ancient, it is yet, in its essentials, and in its developed form as known to-day, harmonious with some of the teachings of modern philosophy and science. It may be noted here that a large number of publications particularly in America and England on 'New Thought', 'Will Power', 'Vitalism', 'Creative Thought', 'Right Thought', 'Self Unfoldment', 'Secret of Achievement', 'Mental Therapeutics' and the like, embody principles which are essentially those of some forms of Shakti Sādhanā both higher and lower. There are also books of disguised magic as how to control others (Vashikarana) by making them buy what they do not want, how to secure 'affection' and so forth which are in certain respects on the same level as Shābara Tantra a lower class of book on Mantras, Shabara meaning Chāndāla the lowest of men.

MAIN OBJECTIONS AGAINST TANTRAS

There are two main objections on which it is said that the Tantras are unVaidic. The first objection is 'Panchatattva' worship or worship with meat, wine, fish, grain and woman. The second is that they contain magic. Taking up the second objection first Sir John Woodroffe says:—

"Magic is not peculiar to the Tantras. It is to be found in plenty in the Atharvaveda. In fact the definition of Abhichāra is 'the Karma described in the Tantras and Atharvaveda'.

“It has been the subject of debate whether the Tāntrik Panchatattva ritual with wine and so forth is a product of Buddhism, and whether it is opposed to Vaidik Dharma. Some have supposed that these rites originally came from yellow Asia, penetrated into India where they received its impress, and again made their way to the north to encounter earlier original forms. I have elsewhere put forward some facts which suggest that these rites may be a continuance, though in another form, of ancient Vaidik usage in which Soma, Meat, Fish and Purodasha formed a part. Though there are some Maithuna rites in the Vedas it is possible that the Shākta ritual in this respect has its origin in Chīnāchāra. Possibly the whole ritual comes therefrom.”

We would here refer to 17th Patala (chapter) of Rudrayāmala where Atharvaveda is very much praised so much so that it is stated that Sāmaveda arose from Atharvaveda; Yajurveda from Samaveda and Ṛgveda from Yajurveda the very opposite of the order in which Vedas are usually taken to have originated. It is stated that all Vidyās and all deities live in Atharvaveda. It is also stated that the principle underlying Atharvaveda transcends all Bhāvās i.e. Pashu, Vīra and Divya. Kundalī is stated to be the supreme deity of Atharvaveda. It is said to be:-

सर्वदेवमयी देवि सर्वमन्त्रस्वरूपिणी ॥११॥

सर्वमन्त्रात्मिका विद्या वेदविद्याप्रकाशिनी ॥१२॥

It also contains the account of Vas'īṣtha's visit to Mahāchīna and his worshipping according to Chīnachāra. Similar account is to be found in the first Patala of Brahmayāmala. For the same purpose may be perused the quotation from Shakti Sangama Tantra contained in the Principles of Tantra by Sir John woodroffe. There it is stated “Go to Mahāchina (Tibet) and the country of Bauddhas and always follow Atharvaveda. ”

बौद्धदेशेऽथर्ववेदे महाचीने सदा व्रज ॥

PANCHATATTVA.

We shall now deal with the Panchatattva. “ It is not uncommonly thought that Vāmāchāra is that Āchāra into which Vāmā or woman enters.” This is only partially true that is to say true of the Sādhakas who worship with Shakti according to Vāmāchāra rites;

but amongst that class also there are Brahmachārīs.) They are Aghoras and Pāshupatas (though they do take wine and eat meat). Some Vāmāchārīs never cease to be chaste (Brahmachārī), such as Oghada Sadhus, worshippers of Batuka Bhairava, Kanthādhāri and followers of the Nāthas, such as Gorakshanātha, Sītanātha and Matsyendranātha. In Nīlakrama there is no Maithuna. Others comprised in the Vāmāchāra class are Kāpālikas, Kālamukhas, Bhāndikeras, Digambaras, Kaulas, and followers of Chīnāchāra. There are different practices in some sects. Amongst the Kālamukhas the Kālavīras are said to be worshipping Kumarīs upto the age of 9 and Kāmamohanas worshipping with adult Shaktis. Some advanced members of Vāmāchārī class refrain from wine and meat also. They may be Brahmakaulas. Further according to the account given in Mahānirvāna Tantra of the Bhāiravīchakra and Tattvachakra “ the Panchatattvas are either real (Pratyaksha, “Idealising” —statements to the contrary are, when not due to ignorance, false), substitutional (Anukalapa) and esoteric (Divyatattva). As regards the second, even a vegetarian would not object to “ meat ” which is in fact ginger, nor the abstainer to “ wine ” which is cocoanut water in a bellmetal vessel. As for the Esoteric Tattvas they are not material articles or practices, but the symbols for Yogic processes ”. It must be said, however, that in some cases there are more unrestrained practices and the accounts given in the Bhairavī and Tattva Chakras may be compared with them.

It would appear that this kind of worship is restricted to one section of the Vāmāchārīs, namely Vīra class where also it is further restricted to the Svabhāvavīras and Mantrasiddhavīras, the other Vīras as well as the Pashu and Divya classes are prohibited from practising the particular kind of worship. There are still further restrictions that a Sādhaka should perform this sort of worship with his own wife (Svakīyāshakti) and it is only when a Sādhaka has no wife or she is incompetent (Anadhikārīnī) that he may take some other Shakti but it is for the purpose of ritual worship only, and that also only during actual worship. Sir John Woodroffe says that the particular

ritual practice is generally of historical interest only. Such practice, to-day is under the influence of the time being transformed. The only thing which can be said about this practice, says Sir John woodroffe, is that it is not a modern invention but seems to be a continuation of ancient Vaidik usage. The argument advanced by the Tantrikas in favour of Panchatattva Sādhakas is:— “ It is irrational to accept one portion of Shāstra as valuable and reject another as worthless. The principle underlying the Sādhana is thus enunciated.

८ यैरेव पतनं द्रव्यैः सिद्धिस्तैरेव चोदिता ।

श्रीकौलदर्शने चैव भैरवेण महात्मना ॥ —कुलार्णवे पंचमोह्लासे श्लो० ४८

The Great Bhairava has ordained in the Kaula doctrine that Siddhi (spiritual advancement) must be achieved by means of those very things which are the causes of man's downfall. ८

The Tantras themselves contain injunctions against unrestrained indulgence in flesh, wine and woman. ८

Kulārṇava Tantra says:—

मद्यपानेन मनुजो यदि सिद्धिं लभेत वै ।

मद्यपानरताः सर्वे सिद्धिं गच्छन्तु पामराः ॥

मांसभक्षणमात्रेण यदि पुण्यमतिर्भवेत् ।

लोके मांसाशिनः सर्वे पुण्यभाजो भवन्निवह ॥

स्त्रीसम्भोगेन देवेशि यदि मोक्षं व्रजन्ति वै ।

सर्वेऽपि जन्तवो लोके मुक्ताः स्युः स्त्रीनिषेवणात् ॥ ८

If a man can obtain Liberation by drinking, all given to drinking would attain Liberation. If one can be meritorious merely by eating meat, all meat-eaters would be meritorious. If they attain salvation by sexual enjoyment with women, all the creatures would be emancipated by sexual intercourse with women.

८ Sir John Woodroffe says that the usage of wine, meat and so forth is itself very old.

“If the subject be studied it will, I think, be found that in this matter those worshippers are the continuators of very ancient practices which had their counterparts in the earlier Vaidikāchāra, but were subsequently abandoned, possibly under the influence of Jainism and Buddhism. In Vaidikāchāra Soma used to be taken instead

of wine. "Meat" was offered in Māngsāshtaka Shrāddha; fish in the Ashtakashrāddha and Pretashrāddha and Maithuna as a recognised rite will be found in the Vāmadevyā Vrata and Mahāvratā of universally recognised Vaidik texts. Possibly however this element of Maithuna may be foreign and imported by Chināchāra" Shakti and Shakta (Ch. V).)

JAINA AND BAUDDHA INFLUENCE

Sir John Woodroffe says ('Shakti and Shakta' p. 60) " that the present day general prohibition against the use of wine, and the generally prevalent avoidance, or limitation of an animal diet, are due to the influence of Jainism and Buddhism which arose after, and in opposition to Vaidik usage. Their influence is most marked of course in Vaishnavism but has not been without effect elsewhere. "

NO PANCHATATTVA WORSHIP IN JAIN TANTRA

It is clear, therefore, that it is due to Jain influence that indulgence in flesh, wine etc, is generally controlled. Accordingly there cannot be and there is not anything in Jain Tantra to favour directly or indirectly any element of Panchatattva worship. Jain Māntrikas have always emphasized on the absolute necessity of Brahmacharya-celibacy in all the Sādhanās. All thoughts of sex are considered the greatest impediments to attainment of success in Mantras by the Jains. Fasting is also recommended for attaining success in the various Anusthānas. Where complete fast is not possible restriction is placed on even the ordinary vegetarian food which Jains always take and meals are recommended to be cut down to single meal per day during such practices with recommendation to exclude sweets, spices, milk and ghee etc. also if possible. This is with a view to control passions and shut out worldly thoughts and bring about pure contemplation by the action of the soul freed to an extent from the bodily bonds. For this very reason worship is recommended to be performed in lonely places, gardens, banks of rivers, temples, or holy places of pilgrimage. It is due to this that ordinary Jains do not like to be classed amongst Tāntrikas whom they consider practitioners of rites with wine and women. The general features of Tāntrik worship will, however, be

noted to exist amongst the Jains by the careful reader of the Tantra here published.

MANTRA AND VAIDIK LITERATURE

The learned editor of *Sādhanmālā*, Dr. Benoytosh Bhattāchāryya though considering magic to be mere superstition says: "If materials were available it could be traceable right upto the beginning of creation, and superstition exists now in more or less aggravated form in almost all civilised countries."

"India is, therefore, not exception and three principal religions of ancient India, Buddhism, Jainism and Hinduism alike shared belief in magic. In India, the course of the development of magical conception can be traced through a continuous literature without a break for over three thousand years, and the different phases of development find expression in the *Ṛgveda*, the *Brāhmanas*, *Atharvaveda*, *Kalpasūtras*, *Dharmasūtras*, *Purānas*, the *Tantras* and the *Pancarātras*."

This will convince the reader of the connection of Mantras with the ancient Vaidik literature. "Even Kautilya the famous author of *Arthashāstra* and the famous Minister of the Emperor Chandragupta recommends to the King to seek the help of magicians to avoid calamities to the State."

TANTRAS AND VEDAS

☪ Hinduism reveals as it were a double framework. on the one hand there are the four Vedas with their *Samhitās*, *Brāhmanas*, and *Upanishads* and on the other what has been called the "Fifth Veda" that is *Nigama*, *Āgama* and kindred *shāstras* and certain especially 'Tāntrik' *Upanishads* attached to the *Saubhagya Kānda* of the *Atharvaveda* such as *Advāitabhāva*, *Kaula*, *Kālikā Upanishads*. "There are Vaidik and Tāntrik *Kalpa Sūtras* and *Sūktas* such as the *Tāntrika Devī* and *Matsya Sūktas*. As a counter-part of the *Brahmasūtras* we have the *Shakti Sūtras* of *Agastya*. There is both Vaidik and Tāntrik ritual such as Vaidik ten *Sangskāras* and the Tāntrik *Sangskāras*, such

as Abhisheka; Vaidik and Tāntrik initiation (Upanayana and Dīkshā); Vaidik and Tāntrik Gāyatrī; the Vaidik Om, the so-called "Tāntrik " Bijas such as Hring; Vaidik Guru and Deshika Guru and so forth. This dualism may be found carried into other matters as well such as medicine, law, writing. So whilst the Vaidik Āyurveda employed vegetable drugs, the " Tāntrikas " used metallic substances. " This indicates that there must have been two sources of religion one of which (possibly in some respects the older) incorporated parts of, and in time largely superseded, the other." Some of the A vaidika cults must have in course of time adopted certain Vaidik rites such as Homa; the Vaidikas in their turn taking up some of the A vaidika practices. It is not possible to sketch here the development of Tantras through all the stages and compare all the salient features thereof with those of the Vedas. For details we would refer the readers to Appendix II to "Shakti and Shakta." It is shown in the said appendix what was the counterpart of the Tāntrik details and rituals in the Vedas. In the Yajnas, Vaidik people principally worshipped the female deity named Sarasvatī who is the same as Vāk or Vāgdevi and who became a lioness and went over to the Devtās on their undertaking that offerings should be made to her before they were made to Agni. For the purpose of attaining eternal bliss they worshipped Rātridevī. Rātri is substantially the same as, but in form different from Vāgdevī; but they are sometimes worshipped as one and the same. Rātri Sūkta describes her as black. It calls Rātridevī by the name of Durgā. Brihad-devatā (II. 79) mentions that Aditi, Vāk, Sarasvatī and Durgā are one and the same. Taking these ideas with that of Sāma-Vidhāna Brahmana we have almost the complete form of Devī who is called at the present day by the name of Kālī. Another devī whose worship is very popular at the present day is Durgā, who has a lion for her carrier. We have mentioned how Durgā is identified with Vāk and how Vāk is identified with lion and this explains how Durgā has a lion to carry her. Shiva Purāna cited above says from Durgā emanated the Tāntrik ten Mahāvidyās. The worship of Rātri is to be performed at night

and the worship of Kālī must also therefore be a night performance. The principal male devatā of Tantras is Mahādeva who is admittedly a Vaidik God. Then again the serpent twining round devas or devīs is foreshadowed by Sarparājnī, the Serpent Queen, who is the same as Vāk. It will be interesting to the Jain readers here to compare the fact that Lord Pārs'vanātha has the king of serpents twining round his body and spreading his hood over him and Devī Padmāvatī who is the Lord's attendant deity and the serpent-queen raising upon her hood the Lord in contemplation in the flood due to heavy rains, as also the fact that there are certain Mantras set forth in the present work relating to S'rīPadmāvatī for acquiring learning which means that her worship is as Vāk. The mysterious Kundalinī is also supposed to confer knowledge (Jñāna) to the yogi worshipper. Kundalinī is the *serpentine force* in the body which when roused passes through the six Chakras or the centres in the spinal cord and goes upto the lotus with a thousand petals namely Sahasrāra and the highest bliss is obtained. Practically every Tāntrik school has adopted this Kundalī Yoga for realisation. There is thus identification of Śrī Padmāvatī with Sarparājnī, Vāgdevī and Kundalinī.

There is identification of Śrī Padmāvatī with various Tāntrik Deities also. Sir John Woodroffe states at P. 93 'Shakti and Shakta': "It is said that the Hangsatārā Mahāvidyā is the Sovereign Lady of Yoga whom Jainas call Padmāvatī, Shaktas Shakti, Bauddhas Tārā, Chīna Sādhakas Mahogrā, and Kaulas Chakreshvarī. The Kādīs call her Kālī, the Hādīs Shrīsundarī and the Kādi-Hādīs Hangsā."

TANTRIK SĀDHANĀ *

AIM AND MEANS

We have given a general indication of the nature and character of Tantras. We shall now describe only the most important features

* अन्यान्यशास्त्रेषु विनोदमात्रम् । न तेषु किञ्चिद्भुवि दृष्टमस्ति ॥
चिकित्सितज्योतिषतन्त्रवादाः । पदे पदे प्रत्ययमावहन्ति ॥

of the Sādhanā—the particular worship prescribed by them. (The aim is the realisation of the pure nature of Ātmā whose light is veiled by the body.) The means employed are many such as worship (Pūjā) exterior or mental, daily, occasional or special, Shāstric learning, austerities (Tapas), Japa or recitation of Mantra, hymns (Stava), sacrifice (Homa), § Prānāyāma, Kundalīyoga, meditation and so forth. Of all these Japa of Dīksha-mantra is the most powerful, because in it the Sādhanā-shakti of the Sādhaka works in conjunction with Mantra Shakti which has the force of fire; in other modes of Upāsana Sādhaka's Sādhanā-shakti alone works. The Sādhanā necessarily varies with the character of the object desired. Thus the Sādhanā of the ordinary householder differs from the higher Sādhanā of the ascetics which consists of Dama or external control over the ten senses, Shama or internal control over the mind (Buddhi, Ahamkāra, Manas), discrimination between the transitory and the eternal and renunciation of both this world and the heaven (Svarga); and both are different from that prescribed for the practitioners of malevolent magic (Abhichāra). * It again varies with different Sādhakas according to their grades. The Sādhakas are divided into three classes viz, Divya, Vīra and Pashu according as the quality of Sattva, Rajas or Tamas predominates in their temperaments.

§ Homa is an ancient Vaidik rite incorporated with other in the General Tāntrik ritual.

* That Kāmya Karma (Rite to achieve a particular object whether good or bad) is not approved and that in it careful performance of various Nyāsas and Ātmarakṣā is necessary appears from the following verses:

सम्यक् कृत्वा न्यासजातमात्मरक्षां विधाय च ।
 काम्यं कर्म प्रकर्तव्यमन्यथाभिभवो भवेत् ॥
 शुभं वाऽशुभं वाऽपि काम्यं कर्म करोति यः ।
 तस्यारित्वं ब्रजेन्मन्त्रो न तस्मात्तत्परो भवेत् ॥
 काम्यकर्मप्रसक्तानां तावन्मात्रं भवेत्फलम् ॥
 निष्कामं भजतां देवमखिलाभीष्टसिद्धयः ॥

—मन्त्रमहोदधी, २५ तरंगे

GURU AND DIKṢĀ

Until a Sādhaka is Siddha he has to practise under the direction of a Guru or spiritual teacher. "It is the Guru who initiates and helps, and the relationship between him and the disciple (Shishya) continues until the attainment of spiritual Siddhi.* It is only from him that Sādhana and Yoga are learnt and not (as it is commonly said) from a thousand Shāstras. Shatkarma Dīpikā says:—

पुस्तके लिखिता विद्या येन सुन्दरि जप्यते ।
सिद्धिर्न जायते तस्य कल्पकोटिशतैरपि ॥

There is no difference between Guru, Mantra and Deva. "Guru is the root (Mūla) of initiation (Dīkshā). Dīkshā is the root of Mantra. Mantra is the root of Devatā, and Devatā is the root of Siddhi." Initiation (Dīkshā) is the giving of Mantra by the Guru. The latter first establishes the vital power (Prāna Shakti) of the Parama Guru in Sahasrāra, (the thousand-petalled lotus) in his own body. Then "as one lamp is lit at the flame of another, so the divine Shakti consisting of Mantra is communicated from the Guru's body to that of the Shishya." Without initiation, Japa Pūjā etc. are useless. * The Tāntrik initiation is for all castes and both sexes. The suitability of a Mantra is ascertained from the Kula-chakra described in Tantras. Initiation by a woman is considered efficacious and that by a mother is eightfold so. Besides the preliminary initiation there are a number of other initiations or consecrations (Abhisheka) marking the stages of advance of the Sādhaka called Pūrnadīkshābhisheka and Mahāpūrnadīkshābhisheka also called Virajā-Grahanābhisheka until Jivana Mukti is attained as a Paramahansa.)

COMMON ELEMENTS OF SĀDHANĀ

We should state here that the main elements of Sādhana are

× उपासनाशतेनापि यां विना नैव सिद्यति ।

तां वीक्षामाश्रयेद्यत्नात् श्रीगुरोर्मन्त्रसिद्धये ॥ कुलार्णवे, १८ उल्लासे, श्लो० ८८

* अवीक्षिता ये कुर्वन्ति जपपूजादिका क्रियाः ।

न भवन्ति प्रियं तेषां शिलायामुत्तबीजवत् ॥ रुद्रयामले, ३ पटले, श्लो० १३

common to all the schools and divisions of Tāntrikas: (such as Pūjā* (inner and outer), Pratimā (idol) or other emblems, Upachāra, obligatory daily-worship, Homa or sacrifice, Vrata (vows), Tapas (Austerities), Mudrā, Mandala, Yantra, Mantra, Japa, Hymns, Purashcharana, Nyāsa, Bhūdashuddhi, Dhyāna and so forth. We must take this opportunity to contradict Sir John Woodroffe, as far as Jains are concerned, when he says that Vāmāchāra ritual is a common ritual and is or was followed by members of all sampradāyas including Jains (see p. 274 Shakti and Shakta). There never was nor is Vāmāchāra ritual amongst the Jains, as Jains have always considered Brahmacharya or celibacy absolutely necessary in all Mantrasādhanās, and as they are strict vegetarians—Ahimsā being their most sacred and inviolable principle. We have already made this quite clear in the foregoing portion of this Introduction dealing with Panchatattva.)

(PSYCHOLOGICAL PRINCIPLES OF TĀNTRIK SĀDHANĀ

We would now give a summary of psychological principles on which Tāntrik Sādhanā is based from the chapter entitled 'Shākta Sādhanā' in Sir John Woodroffe's famous work 'Shakti and Shakta' to enable the reader to appreciate the great complexity and variety of Tāntrik ritual in its proper light. It is well known that mind and body react mutually upon one another. The Sādhanā must therefore be both physical as well as mental. It is admitted now on all hands that not only physical health but mental as well as moral well-being much depends upon the nourishment exercise and the general fitness of the body. It is on moral ground that meat and strong drink are prohibited, as they encourage animal passions. The reader would

* Pūjā has several synonyms such as Ijyā, Archā, Archanā, Vandanā, Bhajanā, Namasyā, Saparyya etc. emphasizing different aspects of the same. It is again Nişkāma or Kāmya. When it is latter, it is preceded by 'Samkalpa' i. e. a state of the resolve to worship and the object with which it is done. Thus the attention and the will of the Sādhaka is focussed on the result to be achieved by the particular worship undertaken by him.

naturally question why then such things are permitted in the secret worship of the Tāntrikas. He would find the answer in the foregoing portion hereof dealing with Panchatattva. Tāntrik Hatha Yoga lays down methods for bodily cleanliness, recommends moderation in food, sexual continence and physical exercise. Periodical fasts are enjoined and during certain worship 'Havishyānnam' (consisting of fruit, vegetable and rice) is prescribed. There are injunctions, though less strict, even for a householder. There are also rules for regulating his sexual life. The aim of preliminary Sādhanā is to secure purity of body and mind by restraining the natural appetites, controlling the senses and all excessive selfishness which transgresses the bounds of Dharma.

The mind is never for a moment unoccupied. The worldly objects continually seek to influence it.

"The object therefore of Sādhanā is firstly to take the attention away from undesirable objects and then to place a desirable object in their stead. For the mind must feed on something. The object is the Ishtadevatā. When a Sādhaka fully, sincerely and deeply contemplates and worships his Ishtadevatā his mind is formed into a Vritti in the form of the Devata. As the latter is all Purity, the mind which contemplates it, is during, and to the depth of, such contemplation pure. By prolonged and repeated worship the mind becomes naturally pure and of itself tends to reject all impure notions. * * * Things are not impure. It is the impure mind which makes them so. He learns to see that everything and act are manifestations of the Divine. He who realises Consciousness in all objects no longer has desire therefor. In this way a good Bhāva, as it is called, is attained which ripens into Devatābhāva. This is the principle on which all Sādhanā as well as what is called specifically Mantrayoga, is based."

The next principle to be noted is that the objects used to fix in the mind the thought of the Devatā are images, pictures, emblems or Yantras. All these are not meant merely for instruction or for visualising the Devatā in the mind, but for actual worship as soon as they are duly consecrated by Prānapratiṣṭhā ceremony. To the superficial persons invocation (Āvāhana) of deity and its dismissal (Visarjana) appear absurd. "That which in fact moves is the mind of the Sādhaka in which, if pure, Spirit manifests Itself." * * * When the Sādhaka's mind fully realises its presence in the Image, the latter as the manifestation

of that Spirit is a fitting object of worship." Yantra worship as herein after explained is meant for advanced sādhakas. ✓

Not only is the object of worship subtle or gross but so also is the ritual with which it is worshipped. " * * * In ordinary worship there is the offer of flowers, light, incense and the like Upachāra. In the subtle inner or mental worship (Antar Pujā) these are but symbols." There is the offering of 'flowers of feeling' for instance in Antar Pūjā.

"Much ignorant talk takes place as to the supposed worship of the Formless. Worship implies an object of worship and every object has some form. But that form and the ritual vary to meet the needs of differing capacities and temperaments: commencing with the more or less anthropomorphic image (or Doll; Puttalī, as those who dislike such worship call it) with its material service reproducing the ways of daily life, passing through pictures, emblems, yantras, and mental worship to adoration of the Point of Light (Jyotirbindu) in which at length, consciousness being merged, all worship ceases." Meditation also is, therefore, gross (sthūla) or subtle (sūkṣma).

Another principle to be noted is the part which the body is made to take in the Tāntrik ritual. Over and above the bodily movement necessary to carry out the ritual all physical action is so prescribed as to aid and emphasise the mental operation. In addition certain suggestive manual gestures (Mudrās) are prescribed. All this is based on the wellknown natural tendency to adopt appropriate movements of the body and gestures of the hands when one speaks with conviction and intensity of feeling.

✓ Like Mudrā Nyāsa also is peculiar to the Tantras. In employing the Nyāsa "the object of the Sādhaka is to identify himself with the Devatā he contemplates and thus to attain Devatābhāva for which it is, in its many forms, a most powerful means.* Regarding the body of the Devatā as composed of Bīja Mantras he not merely imagines that his own body is so composed but he actually places (Nyāsa means placing), these Bījas with the tips of his fingers on the various parts of his own

* The Gandharva Tantra says, "Bhūdashuddhi (i. e., Purification of the elements constituting in their Mahābhūta form the gross body) Rishyādinyāsa, Pithashaktinyāsa, Karanyāsa, Anganyāsa, Mātrikānyāsa, and Vidyānyāsa, O Maheshvaril by means of these Nyāsas a Sādhaka becomes himself full of Devatā". These Nyāsas are said to be for the attainment of some particular object.

body. The Abhīṣhta Devatā is thus in imagination (expressed by outward acts) placed in each of the parts and members of the Sādhakā's body and then with the motion of his arms, he, by Vyāpaka Nyāsa, as it were, spreads the presence of the Devatā all over his body. He thus feels himself permeated in every part by the presence of Devatā and identified with the Divine self in that its form."

Mudrā accompanies some of the ritual acts. Mudrā may be said to be a kind of manual shorthand to express the thought of the worshipper.

Another point to be noted is that the strengthening of the mental Vritti in Tāntrik Sādhanā is by accompanying physical action as also by repetition of words and ideas. Japa of Mantra is an instance. Such repetition has the effect of fixing the idea in the mind. "If the same essential thought can be presented in varied forms the effect is more powerful and at the same time less calculated to tire." "That man is a poor psychologist who does not know the effect of repetition when done with faith and devotion. The inner kingdom yields to nothing but the strong will of the Sādhaka, for it is that will in its purest and fullest strength. The mind of the Sādhaka being thus purified by insistent effort, becomes a fit medium for the manifestation of a Divine Consciousness (Devatābhāva)."

"Much superficial criticism is levelled at this or other ritual, its variety, complexity, its lengthy character and so forth. If it is performed mechanically and without attention doubtless it is mere waste of time. But if it is done with will attention faith and devotion it must necessarily achieve the result intended. The reiteration of the same idea under varying forms brings home with emphasis to the consciousness of the Sādhaka the doctrine, his Scripture teaches him viz, that in his essence he is spirit. The object of this and all the other ritual is to make that statement real experience for the Sādhaka."

"Even when in devotion, complete understanding and feeling are not attained the intention to gain both will achieve success by quickening the worshipper's interest and strengthening the forces of the will."

The Tantra Shāstra is full of symbolism of all kinds—form, colour, language, number, action; and Tāntrik Sādhanā utilises all these to present the essential principle in full variety.)

NĪLA SĀDHANĀ-SHAVA SĀDHANĀ.

We may here mention a peculiar Sādhanā of very limited application being practised by only some Vīra Sādhakas in the cremation ground. It is called Nīla Sādhanā or Black Sādhanā. There are terrifying things in these rituals and therefore only the fearless practise

them. The Vīra trains himself to be indifferent and above all fear. A leading rite is that called Shava Sādhana which is done with the means of a human corpse. The corpse is laid with its face to the ground. The Sādhaka sits on the back of the body of the dead man on which he draws a Yantra and then worships. If the rite is successful it is said that the head of the corpse turns round and asks the Sādhaka what is the boon he craves, be it liberation or some material benefit. It is said that the Devī speaks through the mouth of the corpse which is thus the material medium by which She manifests Her presence.

YANTRA PŪJĀ

“A marked feature of the Tantra Shāstras is the use of Yantra in worship.” It takes the place of idol or emblem when the Sādhaka is sufficiently advanced to worship with the Yantra. Yantra in worship means that by which mind is fixed upon its object of worship i. e. Devatā. It is a diagram drawn or painted on Bhūrja leaf, paper or other substances, engraved on metal, cut on crystal or stone. There are extraordinary Yantras* mentioned as drawn on leopard’s and donkey’s skin, human bones and so forth. The Yantras have different shapes and designs according to the Devatā to be worshipped therein. They also vary according to the object of worship. The devatās are not depicted in the metal or stone Yantras, though in Yantras drawn or painted on Bhūrja leaf or paper, they do appear with their appropriate Mantras. All Yantras have a common edging called Bhūpura a quadrangular figure with four “doors” which encloses and separates the Yantra from the outside world.+ The distinction between the

* शांती वश्ये लिखेद्भूर्जे स्तंभने द्वीपिचर्मणि ।

खरचर्मणि विद्वेषे उच्चाटे ध्वजवाससि ॥

नरास्थिनि लिखेद्यंत्रं मारणे मंत्रवित्तमः ॥—मंत्रमहोदधौ २६ तरंगे श्लो० ५८-५९.

Pens and writing materials also vary in accordance with the object desired to be achieved. (See Mantra-Mahodadhi XXV Taranga VV. 62 to 65 and 55-56).

+The Yantra of śrī Jina is usually a representation of Him as seated in a ‘Samavasarana’ with triple forts and four doors surrounded by ‘Devas,’ ‘Manuṣyas’ and ‘Tiryanchas.’

Yantra and Devatā is that between the body and the self. Mantra is Devatā; and Yantra is Mantra, in that it is the body of the Devatā who is Mantra. Yantras again vary as they are Pūjā or Dhāraṇa Yantras. Although represented generally by a drawing on the flat Yantras are three-dimensional.

“As in the case of the image certain preliminaries precede the worship of Yantra. The worshipper first meditates upon the Devatā and then arouses Him or Her in himself. He then communicates the Divine Presence thus aroused to the Yantra. When the Devatā has by the appropriate Mantra been invoked into the Yantra, the vital airs (Prāna) of the Devatā are infused therein by the Prānapratishthā ceremony, Mantra and Mudrā (see for ritual Mahānirvāna VI, 63 *et seq.*). The Devatā is thereby installed in the Yantra which is no longer mere gross matter veiling the spirit which has always been there, but instinct with its aroused presence which the Sādhaka first welcomes and then worships.”

MANDALA

“The difference between a Mandala (which is also a figure, marked generally on the ground) and a Yantra is that whilst a Mandala may be used in the case of any Devatā, a Yantra is appropriate to a specific Devatā only.” Sarvatobhadra-Mandala is a Mandala commonly used in the worship of any Devatā. Agni Purāna, as well as Nirvānakalikā, the latter an ancient Jain work on Daily worship, Initiation and Installation ceremonies by Śrī Pādaliptasūri (edited with an Introduction by the present writer) mention it. Nirvānakalikā also mentions a Nandāvarta Mandala. There are also mandalas appropriate to each of the five Mahabhūtas* viz, Prithivī, Ap, Tejas, Vāyu and Ākās'a or the four Pīthas.× The

* अर्द्धचंद्रनिभं पार्श्वद्वये पद्मद्वयांकितम् ॥

जलस्य मंडलं प्रोक्तं प्रशस्तं शांतिकर्मणि ।

त्रिकोणं स्वस्तिकोपेतं वश्ये वह्नेस्तु मंडलम् ।

वृत्तं दिवस्तद्विद्वेषे बिंदुषट्कंकितं तु तत् ॥

वायुमंडलमुच्चाटे मारणे वह्निमंडलम् ॥—मंत्रमहोदधौ २५ तरंगे श्लो० २३-२६

× उड्डीयानं चतुरस्रं कामरूपं च वर्तुलम् ।

जालन्धरं च चन्द्रार्द्धं त्र्यस्रः पूर्णगिरिर्भवेत् ॥—कुलार्णवे ६ उल्लासे श्लो० २५

Mandalas also are varied according to the objects sought to be achieved.

MUDRĀ

In Tāntrik Sādhanā the body as well as the mind has to do its part the former being made to follow the latter. This can be seen in bowing, genuflection, Nyāsas, Mudrās, etc. As all else, gesture is here much elaborated.

“Nyāsa, Āsana and other ritual are necessary for the production of the desired state of mind and its purification (Chittashuddhi). The whole aim and end of ritual is Chittashuddhi. Transformation of thought is transformation of being, for particular existence is a projection of thought, and thought is a projection from the Consciousness which is the Root of all.”

THREE MEANINGS OF MUDRĀ

The word Mudra has three meanings. (1) In ordinary worship it means ritual manual gestures, (2) in secret worship it means various kinds of parched cereals, taken with wine and other ingredients, (3) in Yoga it means postures or poses in which not only the hands but the whole body takes part. According to Tantrarāja the Mudrā of Upāsanā is so called because it pleases the Devatās, it being derived from the root ‘Mud’, to please. “It is the outward bodily expression of inner resolve which it at the same time intensifies.” Use of gestures to emphasize or illustrate while speaking is known to all. So in invoking (Āvāhana) the deity an appropriate gesture is made. The Mudrās are numerous. Nirvānakalikā, the Jain work already referred to, has a chapter by itself on Mudrās; so also has Vidhiprapā of Sri Jinaprabhasuri which deals with such as are commonly used in Jain rituals. Sir John Woodroffe says from Shabdakalpadruma and Nirvānatantra chap. 11 that the Mudras are 108—possibly more, of which fiftyfive are in common use.* The Mudrās also vary according to the object

* A work dealing with Mudrās entitled ‘Mudrānighantu’ is published in Tāntrik Texts series together with ‘Tantrābhīdhāna’ and ‘Bījanighantu’ as vol. I with an Introduction by Arthur Avalon.

sought to be achieved. * The present work, 'Śrī Bhairava Padmāvati Kalpa' mentions them in verse 8, Ch. III. Nirvānakalikā actually describes how these Mudrās are formed. Not only Jain Mantrakalpas but the Jain Pratiṣṭhākalpas also mention them for use.

Many of the Mudrās of Hatha Yoga will be found described in works on Yoga such as "Gheranda Samhitā (III Upades'a)", "Hathayoga Pradīpikā" and others. They are in the nature of healthy gymnastics and special positions required for success in Yoga. These Yoga Mudrās produce physical benefits and cure diseases.

The first six Mudrās mentioned above are to be respectively employed in Śānti, Vaśīkarana Stambhana Vidvesa, Uccātana and Mārana. See also the chapter on Mudrā in Nityotsava pp. 90-93. Cf. Śrī Bhairava Padmāvati Kalpa III Adhikāra V. 8

PRELIMINARY RITES

Certain preliminary rites are performed before commencement of Pūjā rites proper. The Sādḥaka on rising in the morning contemplates on Parama Guru in Sahasrāra, performs daily morning duties including ablution and Sandhyā, and after worshipping the deities at the doors of the Pūjāgriha enters the same. "The seat (Āsana) of the worshipper is purified as also the Upachāra (Materials for Worship). Salutation is made to the Shakti of support (Ādhāra-Shakti) the power sustaining all. Obstructive spirits are driven away (Bhūtāpasarpana) and the ten quarters are fenced from their attack by striking the earth three times with the left foot uttering the weapon-mantra (Astrabīja) "Phat" and by snapping the fingers round the head." Other rituals also enter into

* सरोरुहं पाशगदे मुसलं कुलिशं त्वसिः ॥२६॥

षण्मुद्राः कर्मषट्के स्युरथ होमे निगद्यते ।

मृगी हंसी सूकरीति होमे मुद्रात्रयं मतम् ॥२७॥

मध्यमानामिकांगुष्ठयोगे मुद्रा मृगी मता ।

हंसी कनिष्ठाहीनानां सर्वासां योजने मता ॥२८॥

सूकरी करसंकोचे मुद्रालक्षणमीरितम् ।

शांतौ वश्ये मृगी हंसी स्तंभनादिषु सूकरी ॥२९॥ —मन्त्रमहोदधिः २५ तरंगः

the worship besides the offering of Upachāra such as Prānāyama or Breath control, Bhūtashuddhi or purification of the elements of the body, Japa of Mantra, Nyāsa, meditation (Dhyāna) and obeisance (Pranāma).

OBJECTS OF DIFFERENT RITES

The object of Bhūtashuddhi is to purify the mind of its good and evil tendencies which have rendered the Ego a body-bound, selfish small thing.

The object of Nyāsa is to render the body spiritualized by the sound and Mantra Powers.

Prānāyāma, Dhyāna and Japa are essential to withdraw the mind from external attractions and repulsions and to consecrate it to the deity-worship.

FIVE KINDS OF WORSHIP

In the Seventh chapter of the Gautamīya Tantra it is said: "Worship is of five kinds, namely Abhigamana, Upādāna, Ijyā, Svādhyāya and Yoga."

'Abhigamana' is going to the place of worship cleansing the place where Devatā is seated and removing from the image the pastes, flowers, garlands, etc. 'Upādāna' is collecting materials for worship such as flowers, incense, sandal, etc. 'Ijyā' is the name given to worship proper of Ishtadevatā with offerings (Upachāras) and with Mantras after Bhūtashuddhi, Prānāyāma, Nyāsa and Mental worship. 'Svādhyāya' is doing of Japa and recitation of hymns. 'Yoga' is the meditation of Ishtadevatā in one's mind. 'Abhigamana' and 'Upādāna' grant 'Sāmīpya.' 'Ijyā' grants 'Sādṛṣya' (similarity), 'Svādhyāya' grants 'Sārūpya' (Identity of form), and Yoga grants 'Sāyujya' (Union) as their respective fruits. (See Principles of Tantra Vol. II). The nineteen matters one should know before performing 'Shatkarma' are enumerated in the 4th and 5th verses of 25th Taranga of Mantra Mahodadhi given below:

देवता देवतावर्णा ऋतुदिग्दिवसासनम् ।

विन्यासा मंडलं मुद्राक्षरं भूतोदयः समित् ॥

मालामिलेखनं द्रव्यं कुंडलुकुसुवलेखनी ।

षट्कर्माणि प्रयुंजीत ज्ञात्वैतानि यथातथम् ॥—मन्त्रमहोदधौ २५ तरंगे श्लो० ४-५

PLACES FOR WORSHIP

The best places are holy grounds, river-sides, caves, Tīrthas, summits of mountains, confluences of rivers, holy forests, solitary gardens, at the foot of bael tree, valleys, places overgrown with Tulasī plants, pasture lands, temples of Shiva without a bull, at the foot of Asvattha or Āmalakī trees, cowsheds, islands, temples, seashore, one's own house, the abode of Guru, places which naturally lend to generate single-pointedness of mind and places free of animals and solitary.

TIME FOR WORSHIP

“He who desires to reap a full crop of fruits from his rites should begin them in the morning and finish them all by noon.”

According to Nigamakalpalatā “The daily worship should be begun after the passing of the half of the first Prahara and finished at the end of ten Dandas (Ghatis)” i. e. 1½ hours after sun-rise and before expiry of 4 hours after sun-rise. “If Japa and so forth are performed in the morning, it is not improper to perform worship at noon.” The appropriate time for performance of each of the ‘Shatkarma’ is indicated in the following verses:

ऋतुषट्कं वसंताद्यमहोरात्रं भवेत् क्रमात् ॥
 एकैकस्य ऋतोर्मानं घटिकादशकं मतम् ।
 हेमन्तं च वसंताख्यं शिशिरं प्रीष्मतोयदौ ॥
 शरदं कर्मणां षट्के योजयेत्कमतः सुधीः ।

—मन्त्रमहोदधौ २५ तरंगे श्लो० ७-९

पूर्वाह्णे वश्यकर्माणि मध्याह्णे प्रीतिनाशनम् ।
 उच्चाटनं चापराह्णे संध्यायां मारणं तथा ।
 शान्तिकं अर्धरात्रे च पौष्टिकं प्रातरेव हि ॥

—ज्ञानार्णवतन्त्रे २० पटले श्लो० १६६-१६७

Compare the above verses with verses 6 and 7 III Adhikāra, Srī Bhairava Padmāvatī Kalpa and note the practical identity of phraseology.

DIRECTION OF WORSHIP

According to Bhāvachūdāmani “one should perform worship and other ritual acts at night, facing the north” and while worshipping Shiva

always by day as well as night facing the north; while worshipping Vishnu facing east, but facing north is not considered improper; while worshipping Shakti it is best to face north but not improper to face east. Worshipping Śrī Krishna facing east during day and north during night, worshipping Kālī or Chandikā facing north is the best. Worship of Devas should be performed facing east and Devīs facing north. Different directions for 'Shatkarma' are prescribed as in the following verse:

शिवसोमैर्द्रनिर्ऋतिपवनाग्निदिशः क्रमात् ॥
तत्तत्कर्माणि कुर्वीत जपस्तत्तद्दिशामुखः ।

—मंत्रमहोदधौ २५ तरंगे श्लो० ९-१०

Compare Verse 5 III Adhikāra of Śrī Bhairava Padmāvati Kalpa and note the difference.

SEATS AND POSTURES*

Rāghava Bhatta says: Japa, worship, and so forth should be performed sitting in postures, such as Padma, Svastika, Vīra, and so forth otherwise they will be ineffectual.

Sitting with a straight back putting feet within the folds of one's knees is Svastika seat. Placing right foot on the left thigh is Vīrāsana.

ROSARIES

“Rosaries made of beads of Rudrāksha, conchshell, lotus-seed, wild olive (Putranjīva), pearls, crystals, gems, gold, coral, silver, or roots of the Kusha-gross, are prescribed for house-holders.”

It is said that Japa may be done with hands except in Kāmya Karma in which case suitable rosary is necessary. It varies also with the object sought to be achieved. §

* पद्मं स्वस्तिकविकटे कुक्कुटं वज्रमद्रके ॥

शांत्यादिषु प्रकुर्वीत क्रमादासनमुत्तमम् ॥—मन्त्रमहोदधौ २५ तरंगे श्लो० १५-१६

Compare Śrī Bhairava Padmāvati Kalpa III Adhikāra, V. 9.

§ See Śaradātilaka XXIII Patala Verses 116 to 120.

अक्षमालां समाश्रित्य मातृकावर्णरूपिणीम् ।

अथ मुक्ताफलमयी वाङ्मोक्षफलदायिनी ॥

PURIFICATION OF THE " FIVE "

The purificatory rites are five and are preliminary to actual worship.

In the Kulārnava Tantra (VI Ullasa vv. 16-22) it is said:-

"O Devi so long as a Sādhaka does not carry out the five forms of purification, how can he perform worship of a Devatā? These are purification of self (Ātmashuddhi) of place (Sthānashuddhi), of Mantra (Mantrashuddhi), of articles for worship (Dravyashuddhi), and of Devatā (Devashuddhi). Worship without purification of the five is intended only for abhichāra.

"1. Purification of the self of the Sādhaka consists of proper bathing, purification of the elements (Bhūdashuddhi), breath-exercises (Pranāyāma), and so forth, and Nyāsa of six parts of the body (Shadanganyāsa), and all other forms of Nyāsa.

सर्वसिद्धिप्रदा नित्यं सर्वराजवशंकरी ।
यथा मुक्ताफलमयी तथा स्फटिकनिर्मिता ॥
रुद्राक्षमालिका मोक्षे सर्वसंपत्समृद्धिदा ।
प्रवालमाला वश्ये तु सर्वकार्यार्थसाधिका ॥
माणिक्यमाला फलदा साम्राज्यफलदायिनी ।
पुत्रजीवकमाला तु विद्यालक्ष्मीप्रदा सताम् ॥
पद्माक्षमालया लक्ष्मीर्जायते च महती परा ।

रक्तचन्दनमाला तु सर्वभोगप्रदायिनी ॥—ज्ञानार्णवे १७ पटले श्लो० ७-१०

Compare Verse 11 Adhikāra III, Śrī Bhairava Padmāvati Kalpa. Mantra-Mahodadhi, XXV Taranga describes the different rosaries, and different fingers of the hand to be used in counting beads of the rosary, in accordance with the different objects to be achieved :

शंखजा पद्मबीजोत्था निवारिष्ठफलोद्भवा ।
प्रेतदन्तभवा वा हरदोत्था खरदंतजा ॥४०॥
जपमालाः क्रमाज्ज्ञेयाः शान्तिमुख्येषु कर्मसु ।
मध्यमायां स्थितां मालां ज्येष्ठेनावर्तयेत्सुधीः ॥४१॥
शान्तौ वश्ये तथा पुष्टौ भोगमोक्षार्थकै जपे ।
अनामांगुष्ठयोगेन स्तंभनादौ जपेत्सुधीः ॥४२॥
तर्जन्यंगुष्ठयोगेन द्वेषोच्चाटनयोः पुनः ।
कनिष्ठांगुष्ठसंयोगान्मारणे प्रजपेत्सुधीः ॥४३॥

The beads of a rosary for an auspicious or approved object may be 108, 54 or 27 and should be 15 in case of an unapprovable object (Abhichāra)

“2. Purification of place is making the house of worship as clean as the centre of a mirror by dusting, wiping, and so forth, and adorning it with auspicious ornaments, such as powders of five colours, with seat, canopy, incense, lamp, flowers, garlands, and so forth.

3. Purification of Mantra is the performance of Japa of the letters of the alphabet which compose the Mātrikāmantra, once in their regular order (anuloma), and once again in the opposite order (viloma), by linking the letters of the Mūlamantra with them.

4. Purification of articles is the sprinkling on articles of worship of water sanctified by a recital of the Mūlamantra and the weapon Mantra, and then displaying the Dhenumudrā (cow-mudrā) over them.

5. Purification of Devatā is the placing of the image of the Devatā on the Pītha, invoking the Shakti of the Devatā into it by means of Astramantra Prānamantra and so forth, then bathing it (at least) thrice along with recital of Mūlamantra, and finally adorning it with garments, ornaments, and the like, and offering incense, light and so forth. These five forms of purification must be performed first, and then the worship should be commenced.” (From Principles of Tantra Vol. II)

BHŪTASHUDDHI

Bhūtashuddhi, * which is a part of Ātmashuddhi, is an important Tāntrik rite and means purification of five ‘elements’ of which the body is composed. These elements are not to be understood to be gross ‘earth,’ ‘water,’ ‘fire,’ ‘air’ and ‘ether’ but the five forms in which Prakriti manifests Herself. These have centres of operation in the five Chakras Mūlādhāra to Vishuddha in the spinal cord in the human body. We have described above Kundaḷīyoga and mentioned Kundalinī ordinarily remaining coiled in the lowest Chakra viz, Mūlādhāra. She is considered a form of the Saguna Brahman and is also identified with the presiding deity of the Mantra i. e. Ishtadevatā. “In Kundalīyoga she is aroused and brought up through the five centres, absorbing as She passes through each the Bhūta of that centre, the subtle Tanmātrā from which it derives and the connected organ of sense (Indriya). Having absorbed all these, She is led to the sixth or mind centre (Ājnā) between the eyebrows where the last Bhūta or ether is absorbed in mind, and the

* देवार्चायोग्यताप्राप्त्यै भूतशुद्धिं समाचरेत् ॥—मन्त्रमहोदधिः प्रथमस्तरंगः

latter in the Subtle Prakriti. The last in the form of Kundalī Shakti then unites with Shiva in the upper brain called the thousand petalled lotus (Sahasrāra). In Yoga this involution actually takes place with the result that ecstasy (Samādhi) is attained. But very few are successful Yogis. Therefore Bhūtashuddhi in the case of the ordinary worshipper is an imaginary process only. The Sādhaka imagines Kundalī, that She is roused, that one element is absorbed into the other and so on, until all is absorbed in Brahman.

He then thinks of the 'black man of sin', in his body. He inhales meditating on 'Yam' the Vāyu-Bīja for 16 instants and dries up the sinful body; holds breath meditating on 'Ram' the AgniBīja for 64 instants and burns the same with all sinful inclinations;* exhales meditating on 'Vam' the VarunaBīja for 32 instants and bathes the burnt-body with the nectar-like water from head to feet. The Sādhaka then thinks that a new Deva-body has come into being. Then meditating on 'Lam' the Prithvī Bīja in the Mūlādhāra and by divine gaze he strengthens the same. Then placing his hand on his heart and uttering Mantra 'Āng, Hrīng, Krong, Hangsah, So'ham he infuses into the new body the Prānas of the Devī (i. e. Ishtadevatā). Thus performing Bhūtashuddhi the Sādhaka should think that he is one with the Devī.

NYĀSA

Nyāsas should be performed after first purifying the materials of worship (द्रव्य शुद्धि) and so forth.

Nyāsa is a very important and powerful Tāntrik rite. It is performed by placing the tips of the fingers and palm of the right hand on various parts of the body accompanied by recitation of Mantra. It is of many kinds, e. g. Jīva-nyāsa, Mātrikā or Lipi-nyāsa, Rishi-

*Cf. Kalmaṣa-dahana rite in Jain Mantra-kalpas which is performed by touching the middle of the left arm and thrice reciting the Mantra:

“ॐ विद्युत्सफुलिगे महाविद्ये सर्वकल्मषं दह २ स्वाहा ॥”

The detailed Jain Bhūtashuddhi rite is given at p. 2A of Nirvānakalikā. Its similarity to the rite above described may be noted.

nyāsa, Shadanga-nyāsa on the body (Hridayādi-shadanga-nyāsa) and with the hands (Angushthādi-shadanga-nyāsa) Pītha-nyāsa and so on. The Kulārṇava (IV-20) mentions six kinds. Each of these might come under one or the other of the four general heads.

“Nyāsa also has certain physical effects for these are dependant on the state of mind. The pure restful state of meditation is reflected in the body of the worshipper. The actions of Nyāsa are said to stimulate the nerve centres and to effect the proper distribution of the Shaktis of the human frame according to their disposition and relations, preventing discord and distraction during worship, which itself holds steady the state thus induced” pp. 292-293 ‘Shakti and Shākta.’

JIVA-NYĀSA

Jiva-nyāsa is infusion into the Sādhaka's body purified by Bhū-tashuddhi rite of the life-Prāna of the Ishtadevatā accompanied by recital of Mantra. By this the body is thought to become that of Devatā.

MĀTRIKĀ-NYĀSA

Mātrikā-nyāsa is the placing the fifty letters of the Sanskrit alphabet, which are considered Mantra-bodies of the Devatā on the body of the Sādhaka. They are so placed, mentally saying ‘Om Ham Namah’ etc., in the six inner centres (Chakra) in case of Antarmātrikā-nyāsa; and externally on the body in case of Bahyamātrikā-nyāsa. This Mātrikā-nyāsa again is Sṛsti Mātrikā Nyāsa (i. e. Creative) or SanghāraMātrika Nyāsa (Dissolving).

VIDYĀ-NYASA

Nyāsa of Vidyā should be done on the head, Mūlādhāra, heart, three eyes, two ears, mouth, two arms, back, knees, and navel.”

RISHI-NYĀSA

Rishi-nyāsa consists of salutation on the head to Rishi of the particular Māntra and salutation in the mouth to the particular meter of the verse of the Mantra and in the heart to the Devatā and in the hidden part (Guhya) to the Bīja and also on the two feet and on the whole of the body.

SHADANGA-NYĀSA*

In Shadanga-nyāsa certain letters are placed with the Mantras Namah, Svāhā, Vashat, Vaushat, Hūm, Phat, on the heart, head, crown-lock (Sikha), eyes, middle of arms and the front and back of the palms.

KARA-NYĀSA

In Kara-nyāsa the Mantras are assigned to the thumbs, index fingers, middle fingers, fourth fingers, little fingers, and the front and back of the palms. The meaning of Nyāsa thus becomes clear. By associating the Divine with every part of the body and with the whole of it, the mind and body are sought to be made divine to the consciousness of the Sādhaka. They are that already but the mind is made so to regard them.

SHODHĀ-NYĀSAS‡

In Mantramahodadhi (XI Taranga) V. 48 it is stated that Shodhānyāsas and other Nyāsas should be performed for good luck, but are not described for fear of lengthening (of the work) and because they are not compulsory. They consist of Ganesha, Graha (Planet), Nakṣatra (Asterism), Yoginī, Rāshi (Zodiacal sign) and Pītha Mātrika Nyāsas. They are described fully in the commentary of the said verse 48 of XI Taranga of Mantra-Mahodadhi.

“In the Vīra Tantra it is said:

“All the sins of a Sādhaka are destroyed if the Shodhā-Nyāsa which is the principal of all Nyāsas, is performed. Shodhā-Nyāsa overcomes the poison of snakes, prevents death from accidents, and destroys evil Grahas and diseases. All harmful things are destroyed by the force of Shodhā-Nyāsa, and enemies are made thereby friendly.

The poems of a Sādhaka who performs Shodhā-Nyāsa sweetly flow in waves like streams of grape-juice. The eight forms of Siddhi, namely Animā and so forth, lie within the hollow of his hands. Contemplation in the performance of Shodhā-Nyāsa destroys all sins of body, speech, and mind. All lesser sins are destroyed by recourse to Shodhā-Nyāsa. A Sādhaka who has attained Siddhi in Shodhā-Nyāsa can, if he

* Amongst Jains Shadanga-Nyāsa and Kara-Nyāsa appear to be usually employed. Matrikā-Nyāsa is sometimes employed but the other Nyāsas are scarcely employed.

‡ For Mahāshodhā-Nyāsa see Kulārūpa Tantra IV Ullasa.

desires, enter into whatever form he sees. The life of him to whom a Sādhaka who has done Shodhā-Nyāsa bows is shortened. Even Devatās, not to speak of men, tremble with fear at the sight of a Sādhaka who performs Shodhā-Nyāsa." P. 375 Principles of Tantra Vol. II.

DHYĀNA*

In 'Dhyāna' or meditation the form of the deity which is being worshipped is contemplated on with such vivid imagination, concentration of thought and devotion that the image becomes vivified and remains before the mind's eye throughout the course of worship. This 'Dhyāna' however is 'Sthūla' or gross. The 'Sūkṣma' or subtle 'Dhyāna' is contemplation of the deity in its subtle aspect as formless or as 'Light'. We have already referred to this (See ante pages 33 and 45). The deity in 'Sthūla' or gross Dhyāna is contemplated on in its natural complexion or colour and with usual ornaments and vehicle.

यस्य देवस्य यद्रूपं यथाभूषणवाहनम् ।

तद्रूपं ध्यायते नित्यं स्थूलध्यानमिदं विदुः ॥ घेरण्डसंहिता, उपदेश ६ श्लो० ८

Such is the contemplation in Niṣkāma worship whether daily (Nitya), occasional (Naimittika) or special (Mahāpūjā). The Dhyāna is the same in 'Puraṣcarana' also; because 'Puraṣcarana' by itself is not 'Kāmya' i. e. performed with a particular desire. Puraṣcarana is only a preliminary to Kāmya Karma. When the worship is Kāmya' as in Shatkarma, Dhyāna varies in colour. (See ante section entitled 'Contemplation Colours and Emotions' page 23 et seq.) The 'Dhyāna' in case of 'Sānti' (Peace of body or mind) is contemplation of the deity, its ornaments and apparels as white; in case of Vashīkarana (Fascination) or Ākarṣana (Attraction) it is red; in case of 'Stambhana' (Paralysing or stopping any person, thing, feeling or activity) it is yellow; in case of Vidveṣana (Creating enmity between friends) it is of smoke colour; in case of 'Uccātana' (Driving away a person) also it is of smoke colour; and in case of Mārana (killing) it is of black colour.

*See the present writer's articles on 'Yogīśvara Śrī Hemacandrāchārya and Dhyāna - Nirūpana' in Gujarati in 'Suvāsa' (a magazine published at Baroda) Vol. I, 12 & Vol. II, 2 for further information on Dhyāna.

श्वेतं ध्यानं भवेच्छान्त्यै पीतं स्तम्भनकारकम् ।
 वश्याकर्षणयो रक्तं क्षोभणार्थं प्रियावहम् ॥
 कृष्णं च मारणे प्रोक्तं धूममुच्चाटनादिके ॥

—ज्ञानार्णवतन्त्रे, २० पटले श्लो० १७०-१७१

Dhyāna is again said to be of three kinds. 'Sātvika', 'Rājasa', and 'Tāmasa' and employed for different objects.

शान्तिके सात्त्विकं देवि श्वेतवर्णं विचिन्तयेत् ॥
 वश्ये तु राजसं देवि रक्तवर्णं विचिन्तयेत् ।
 तामसं क्रूरकार्येषु कृष्णवर्णं विचिन्तयेत् ।
 आत्मरक्षां पुरा कृत्वा पश्चात् कर्माणि साधयेत् ।
 योऽन्यथा कुरुते मोहात् स भवेद्देवतापशुः ॥

—कुलार्णवे, १७ उल्लासे श्लो० १२५-१२७

See also V. 6, Appendix 30 to the present work; V. 31 Chapter VIII Yogashastra by Hemachandrāchārya and VV. 40 and 47 XI Ullasa, Vivekavilāsa.

JAPA

Japa is of three kinds viz. Vāchika or Bhāṣya, Upāngshu and Mānasa.* The first is the lowest and the last the highest form. In the first Mantra is distinctly and audibly recited. In the second which is less gross and therefore superior to the first the Mantra is not uttered. There is a movement of the lips and tongue without any articulate sound being heard. In the highest form which is mental utterance there is neither articulate sound nor movement. There is merely meditation on the letters of the Mantra.

“Certain conditions (See Nityotsava pages 171-172) are prescribed as those under which Japa should be done, relating to physical cleanliness the dressing of the hair, garments worn, the seated posture (Āsana), the avoidance of certain states of mind and actions, and the nature of the recitation. Japa is done specified number of times, in lakhs by great Sādhakas. If the mind is really centred and not distracted throughout these long and repeated exercises the result must be successful.”

* Nirvānakalikā (page 4 B) also says so.

HOMA, TARPANA, BRĀHMANA-BHOJANA ETC.

Puraṣcarana is comprised of five parts: (1) Worship three times a day (ii) Japa (above described) (iii) Homa (Sacrifice) (iv) Tarpana (satisfying the deity with water) (v) Brāhmana-Bhojana (Feasting of Brāhmanas):

पूजा त्रैकालिकी नित्यं जपस्तर्पणमेव च ।

होमो ब्राह्मणभुक्तिश्च पुरश्चरणमुच्यते ॥—कुलार्णवे १५ उल्लासे श्लो० ८

Then there is the rule for substituting at least double Japa instead of the part which cannot be performed:

यद् यदङ्गं विहीयेत तत्संख्याद्विगुणो जपः ।

कुर्याद् द्वित्रिचतुःपञ्चसंख्यां वा साधकः प्रिये ॥—कुलार्णवे १५ उल्लासे श्लो० ९

'Kundas' or the Sacrificial pits for performance of Homa are of different shapes according to the object desired to be achieved:

योनिकुण्डं वाक्प्रदं स्यादाकृष्टिकरणं भगम् ।

लक्ष्मीप्रदं वर्तुलं स्याच्चन्द्रार्धे हि त्रयं भवेत् ॥

नवत्रिकोणकुण्डं तु खेचरीसिद्धिदायकम् ।

चतुरस्रं शान्तिलक्ष्मीपुष्टिवृध्यम्बुकारणम् ॥

षट्सं सर्वसंपत्तिधनसौभाग्यवर्धनम् ।

पद्मांकं सर्वसंपत्तिकारणं सुरवन्दिते ॥

अष्टपत्रं वरारोहे समीहितफलप्रदम् ।

एतानि सर्वकार्याणि चतुरस्रे भवन्ति हि ।—ज्ञानार्णवतन्त्रे, २० पटले श्लो० २४-२७

वृत्तं पद्मं चतुष्कोणं त्रिषट्कोणं दलेदुवत् ।

तोयेशसोमशक्राणां यातुवाय्वोर्यमस्य च ॥

आशासु क्रमतः कुण्डं शान्तिमुख्येषु कर्मसु ॥—मंत्रमहोदधौ, २५ तरंगे श्लो० ६०-६१

'Samidhs' (Chips of wood), oil, fire and materials for sacrifice also vary according to the object to be achieved. (See Mantramahodadhi XXV Taranga, Jnānārṇava Tantra XX Patala and Nityotsava pp. 170-171.)

Usually the number of 'Āhutis' or oblations to fire in Homa is one tenth of the number of Japa, the number of Tarpana is one-tenth of the number of Āhutis; and the minimum number of Brāhmanas to be feasted is one tenth of the number of Tarpana. Sometimes 'Suvāsinīs'

(Married women) and 'Kumarīs' (Virgins) are also feasted. If one cannot afford to feast the number of Brāhmanas stated above, 'Abhiṣeka' or 'Mārjana' should be performed with Kusha grass dipped in water one tenth of the number of Tarpana, and one tenth of the number of 'Abhiṣeka' or 'Mārjana' should be the number of Brāhmanas to be feasted.

SIDDHI

If success is not attained after completion of one Puraṣcarana two or even three puraṣcaranas should be performed. If success is not even then attained well known methods of obtaining 'Siddhi' should be employed, because if complete success be attained in respect of a single Mantra, success would be attained in respect of all Mantras and nothing would be impossible to be performed by such a 'Siddha' worshipper:

सम्यक्सिद्धैकमन्त्रस्य पंचांगोपासनेन हि ।

सर्वे मन्त्राश्च सिध्यन्ति तत्रभावात् कुलेश्वरि ॥

सम्यक्सिद्धैकमन्त्रस्य नासाध्यं विद्यते क्वचित् ।

बहुमन्त्रवतः पुंसः का कथा शिव एव सः ॥—नित्योत्सवः पृ. १६१

UPACHĀRA

In Tāntrik worship the materials used or rites performed are called Upachāras. Commonly they are sixteen in number but sometimes they are more and sometimes less. In the Sanatkumāra Tantra it is said "The Ishtadevatā should be worshipped daily with sixteen Upachāras, or with ten if it is not possible to worship with sixteen, or with five Upachāras if it is not possible to worship with even Ten". Mahānirvānatantra 13th Ullāsa gives the sixteen, ten and five Upachāras in the following verses:

आसनं स्वागतं पाद्यमर्घ्यमान्चमनीयकम् ।

मधुपर्कस्तथाचम्यं स्नानीयं वस्त्रभूषणे ॥२०३॥

गन्धपुष्पे धूपदीपौ नैवेद्यं वन्दनं तथा ।

देवार्चनासु निर्दिष्टा उपचाराश्च षोडश ॥२०४॥

(1) A seat, (2) welcome, (3) water to wash the feet, (4) offering (of rice, flower, sandal paste, Durvā grass and water in the vessel of kushi), (5) water for rinsing the mouth, (6) Madhuparka (Honey, ghee,

milk and curd), (7) water for sipping, (8) water for bathing, (9) clothes (10) ornaments, (11) gandha (scent), (12) flowers, (13) incense, (14) light, (15) edibles, (16) and Vandana (obeisance), are the sixteen offerings prescribed in the worship of Devas.

पायमर्ध्यञ्चाचमनं मधुपर्कचमौ तथा ।

गन्धादिपञ्चकं चैते उपचारा दश स्मृताः ॥२०५॥

(1) water to wash the feet, (2) offering (of rice, sandal paste, flower, water and Durvā), (3) water (for rinsing the mouth), (4) Madhuparka, (5) water (for sipping), (6) gandha, (7) flowers, (8) incense, (9) light, and (10) edibles. These are known as the ten upachāras.

गन्धपुष्पे धूपदीपौ नैवेद्यं चापि कालिके ।

पञ्चोपचाराः कथिता देवतायाः प्रपूजने ॥२०६॥

(1) Gandha, (2) flowers, (3) incense, (4) light, and (5) edibles, O Kālikā ! are called Panchopachāra in the worship of a deity.

The five upachāras according to the present work however, are set forth in the following verse of the third chapter.

आह्वानं स्थापनं देव्याः सन्निधीकरणं तथा ।

पूजां विसर्जनं प्राहुर्बुधाः पञ्चोपचारकम् ॥२४॥

(1) Invocation, (2) installation of the goddess, (3) bringing her near to oneself (i. e. one's consciousness), (4) worship and (5) giving her a send off are called by the wise Panchopachāra. Jain Māntrik works generally mention such Panchopachāra Pūjā. Here it must be remembered that word Pūjā here stands for a composite rite in which are offered water for bath, sandal-paste 'Attar' etc. as 'Gandha', flowers, incense, light, rice, edibles and fruits. Amongst the Jains the minimum things offered in Pūjā are these eight from which the Pūjā is called Aṣṭa-Prakāri i. e. eight fold. The Jains have also Pūjās which have either seventeen or twentyone varieties. Really speaking these varieties of Pūjā correspond to the main items in Ṣoḍashopachāra worship excluding of course the seat, welcome and obeisance. The Jain rite of offering water and giving bath is preceded by Pancāmṛtsuāna in which are included milk, ghee, curd, sugar-candy or sugar-cane-juice and water.

MĀHĀPŪJĀ

“The Gandharva Tantra says: ” A Mahāpūjā, with all the various articles therefor and complete in all parts, should be performed every month of every year on auspicious days. Besides this, worship of Ishtadevatā is a daily work. A Sādhaka may perform occasional rites when he is capable of thoroughly carrying out those of daily obligation. When he thus becomes an adept in the performance of both the daily and occasional rites, then he may think of performing those which are done for the attainment of a particular end (Kāmya).”

“A great Pūjā, with abundance of materials therefore should be performed on a fourteenth lunar day, or an eighth lunar day, or a full moon day, or between two months (the day between two months or the last day of a month), or on a Mahābhūta day. If the fourteenth day of a dark fortnight be a Tuesday, that day is called a Mahābhūta day. Any special performance on this day causes Bhūtas (beings and things) to come within the control of the Sādhaka. Again if there is a conjunction of the Pushya * Nakshatra on that day, performance on that day is productive of countless fruits.”
(p. 321 Principles of Tantra Vol. II) ✓

* One of the twenty-seven “lunar mansions”.

Mantrayana-Vajrayana And Tantrism Amongst Buddhists

IN course of the foregoing discussion, we have dealt generally with the Hindu Tantras of all sects of worshippers. We shall now deal with the Buddhist Tantras in particular as they are equally important in the History of Tantras and Mysticism and shall then describe Mysticism amongst Darvishes in a separate section. Finally we shall treat of Mantravāda amongst Jains in comparatively greater details and then in a separate part the contents of the work here published and notes and comments on the works in the appendices and the biographies of the authors thereof.

The Buddhists are divided into two principal sects viz, Mahāyāna and Hīnayāna. The Northern Buddhists of Tibet, China and Japan belong to the former sect and they term those of the South i. e. Ceylon, Burma and other places 'Hīnayānists' which term is not of a complimentary character. The Mahāyānists i. e. the followers of the Greater Vehicle are so called because they strive for the enlightenment of the whole universe, while the Hīnayānists, i. e. the followers of the Lesser Vehicle are so called, because each of the followers seeks Nirvāna and Arhatship for himself only. Vajrayāna or Mantrayāna is a development and a branch of the Mahāyāna. Vajrayāna is a form of Tāntric Northern Buddhism. At first Buddhism was divided into three Yānas viz, (1) Shrāvakayāna (2) Pratyeka-BuddhaYāna and (3) Bodhisattvayāna. With the advent of Padma-Sambhava (the son of the famous Indrabhūti who flourished in circa 717 A. D.) who was the founder of the Mantrayāna school in Tibet, Bodhisattvayāna developed according to Kazi Dawa-Samdub into Vajrayāna and Mantrayāna the same being divided further into the following main divisions: (1) Kriyātantra-Yāna, (2) Charyā or Upāya-tantra-Yāna (3) Yoga-Tantra-Yāna, the last being further subdivided into three (4) Mahā-Yoga-tantra—Yāna, (5) Anuttara-Yoga-tantra-Yāna, (6) Ati-Yoga-tantra—

Yāna. The Yogāchāra school* which evolved out of Sūnyavāda of the Mādhyamakas did to an extent contribute to the development of Tantras, but it was the Vajrayāna which was the chief contributor.

Vajrayāna literally means 'adamantine vehicle' but really 'Sūnya vehicle'. Sūnyatā is called Vajra, because it is firm and sound, cannot be changed, cut or pierced, cannot be burnt, and cannot be destroyed. According to the Mādhyamakas Nirvāṇa is Sūnya; according to Yogāchāra which is a later development of Sūnyavāda, besides Sūnya Vijnāna, a positive element, is present. While according to Vajrayāna, besides the two, the element of Mahāsukha 'eternal bliss' is also present. This Vajrayāna further introduces the theory of five Dhyāni Buddhas,* presiding over five Skandhas, and families of the five Dhyāni Buddhas who come forth when needed. Five Bodhisattvas and their Śaktis are the first to emanate. It also introduced the worship of various deities with their Śaktis and a large number of gods or goddesses and their Sādhanās, Stutis etc. Vajrayāna§ can be said to be direct development of the Yogācāra school and the Vijnānavāda it inculcates rather than the Mādhyamaka school.

Asaṅga, brother of the famous Vasubandhu, who flourished in the fourth century of the Christian era is said to have introduced

*The five Dhyāni Buddhas are Akṣobhya presiding over Vijnāna Skandha, Vairocana over Rūpa Skandha, Ratnasambhava over Vedanā Skandha, Amitābha over Samjñā Skandha, and Amoghasiddhi over Samskāra Skandha. Their colours are given below. Vajradhara embodies in Himself all the five Dhyāni Buddhas, is of blue colour and has two hands crossed on his breast, the right holding an adamant (Vajra) and the left a bell. He is supposed to be over all the Dhyāni Buddhas and is called the Sixth.

जिनो वैरोचनो ह्यातो रत्नसम्भव एव च ।

अमिताभोऽमोघसिद्धिरक्षोभ्यश्च प्रकीर्तितः ॥

वर्णा अमीषां सितः पीतो रक्तो हरितमेचकौ ॥-साधनमाला पृ. ५६८-६९

§ The writer acknowledges his indebtedness for much of the information about Mantrayāna and Vajrayāna given here to the learned authors of the Introduction to Sādhanamālā, Shāktasampradāya (Gujarati) and Introduction to Shri Chakrasambhāra.

Tāntrism amongst the Buddhists which was transmitted from preceptor to pupil in the most secret manner upto the time of Dharmakīrti. The first to openly a vow and preach this doctrine were Saraha, Nāgārjuna, Luipāda, Padmavajra, Anaṅgavajra and Indrabhūti.

Guhyasamāja alias Śrīsamāja is probably the most authoritative and original work from which Tāntrism drew its inspiration. It is written in the form of a Sangīti and believed to have been delivered in an assembly of the faithful by the Sarvatathāgatakāyavākitta. Dr. B. Bhattāchāryya, the learned editor of Sādhanamālā says in his Introduction about this work:—

“This is probably the first work of the Tantra school, and Asaṅga quite conceivably may have had something to do with it, as it is commonly believed that the Tantras were introduced by him from the Tuṣita heaven where he was initiated in mysticism by Maitreya. But of course, this view cannot be said to be definite, or to be based on sufficiently strong evidence, and it is very doubtful whether we will ever be in a position to trace the origin of the Tantra in the most precise manner possible.”

“Vajrayāna incorporated many leading tenets of Mantrayāna which was a form of Mahāyāna Buddhism, where Mantras, Mudrās, Mandalas, and gods were given the greatest prominence for the attainment of Siddhis or else Nirvāṇa or omniscience.”

The earliest work of Mantrayāna viz. Vidyādharapītaka—forming part of the canonical literature of the Mahāsaṅghikas is not now available; another work of Mantrayāna however viz. Mañjushrīmūlakalpa is available. It is in the style of Mahāyāna Sūtras in the Sangīti form. Dr. B. Bhattāchāryya considers the date of the work to be about 200 A. D.* Mantras and Mudrās therein are not systematised as in the later Vajrayāna works. There is no mention therein of Panchatattva worship. The Mūlakalpa mentions Mantrayāna but not Vajrayāna which is for the first time mentioned in “Guhyasamāja”. Dr. B. Bhattāchāryya surmises that there is a history of development of several centuries behind that work and says that if Tantrayāna could be traced to the root probably “the opinion of Śāntarakṣhita and Kamalaṣīla that instructions of Tan-

* Winternitz however says: “But his arguments are by no means convincing”, that is, to fix the date so early as 200 A. D. See P. 635 History of Indian Literature.

tras, Mantras, Mudrās and Mandalas were delivered by Buddha himself for the benefit of such of his followers who cared more for the material prosperity than the spiritual” would be found to be correct.

On the authority of *Pag Sam Jon Zan* he also says that Tāntrism was first developed in Uddiyāna and thence transmitted to the other Pīṭhas, Kāmākhyā, Srihaṭṭa and Pūrṇagiri and the rest of India.

We have mentioned above some of the earliest prominent promulgators of Buddhist Tāntrism. Of them Saraha (633 A. D.) according to both Tārānāth and author of *Pag Sam Jon Zan* as also Cakrasamvara succession list was one of the earliest promulgator of Buddhist Tāntrism. He was also known as Sarahabhadra and Rahulabhadra. Tāntrism got publicity with him and therefore its commencement is taken to be seventh century A. D. He introduced Buddhakapāla Tantra and Luipā the first Siddhācārya (669 A. D.) the Yoginī Sañcaryā, Kambala and Padmavajra (693 A. D.) introduced the Hevajratantra, Kṛṣṇācāryya (717 A. D.) the Sampuṭatilaka, Lalitavajra (693 A. D.) the three divisions of Kṛṣṇayamāritantra, and Dārikapā (753 A. D.) the Kālacakra. We may mention here that the great Tāntrika Nāgārjuna flourished in 645 A. D. and was different from Nāgārjuna the founder of the Mādhyamaka school who flourished about 150 A. D. The Tāntrika Nāgārjuna was a prolific writer of Tantras and is said to have imported the worship of Ekajaṭā* from Bhota i. e. Tibet. Śavarīpā (657 A. D.) is another interesting historical figure noted for his magical prowess and can be easily identified as the author of the collection of Mantras distinctly known as Śābara Mantras. He belonged to the hill tribe called the Śavaras or huntsmen in Bengal.

*Dr. B. Bhattāchāryya's inference—that India knew of no deity as Ekajaṭā before Nāgārjuna's time—however is unwarranted. The colophon of Ekajaṭā's Sādhanā, in Sādhnamāla, does not say so. It only means that the Sādhanā was rescued or restored and not that the deity was imported. Besides Nāradiyapurāna Adh. 85 v. 123 actually mentions Ekajaṭā. Ekajaṭā is also mentioned in Guhyasamāja at p. 88. Tārā in Nāradiya purāna Adh. 85 is not described with Akṣobhya on the crown, nor decked with Mudrās. Kālī, Sarasvatī and Bhadrakālī cannot therefore be rightly said to be Buddhist in origin.

He composed a Sādhanā of Kurukullā and was the originator of Vajrayoginī cult where the deity worshipped is of red colour. The Sābara Mantras are referred to by the famous Jain Ācharya Haribhadrasūri in his work Śāstravārtāsamuccaya:-

मन्त्रादीनां च सामर्थ्यं शाबराणामपि स्फुटम् ।

प्रतीतं सर्वलोकेऽपि न चाप्यव्यभिचारि तत् ॥—श्लो० ६२३ ॥

Padmavajra mentioned above also wrote a work named Guhyasiddhi which seems to have been much popular in Tibet. He advocates there in objectionable rites and practices specially relating to the Mahāmudrā or Śakti. According to him all these rites and practices originated from Buddha himself and were recorded in the work Guhyasamāja alias Śrīsamāja. The goal preached by him in the said work is stated as not possible to be reached without the Śakti. It would seem the Panchatattva worship gathered strength from Padmavajra's said work although it must have started about the time of Guhyasamāja. His pupil Anaṅgavajra* (705 A. D.) wrote several works on 'Hevajratānta' introduced by his preceptor. He wrote Prajñopāyaviniscayasiddhi also.

Indrabhūti who flourished about 717 A. D. wrote several works on Tantras and was considered an authority on Vajrayāna and Tantra, long after his time. The Sādhanamālā includes the Sādhanās composed by him named Kurukullā Sādhanā. One of his important works viz, Jnānasiddhi describing shortly the principal Vajrayānist doctrines and rites has been discovered and published in the Gaekwad's Oriental Series. This work also preaches that if the kind of knowledge there described is obtained Bodhi can be attained even if one indulges in immoral actions or takes animal food or strong drinks.

Kṛṣṇāchāryya who flourished about 717 A. D. is said to have introduced Tantras in which the male and female deities sit clasping

*Dr. B. Bhattāchāryya in his article 'Glimpses of Vajrayāna' says that Anaṅgavajra renounced Buddhism in his later life and became one of the saints of the Nāthapantha, and that he is identified with Gorakṣanātha.

each other. He may be identified with Kṛṣṇarāja who introduced worship of Vajrasarasvatī. Lakṣmīkarā belonged to the royal family of Uddiyāna and was the sister of the famous Indrabhūti. She wrote an interesting work named 'Advayasiddhi'+ in which she preached certain novel doctrines such as worship of one's own body where all the Gods reside. She said once the truth was known there was no restriction for the worshipper. He may eat or drink anything. He may violate any law and that there was no need to undergo any suffering or to fast or to bathe. She however stated that women of all castes should be respected as they were embodiments of Prajnā. Since her time this new teaching won many adherents who came to be known as Sahajayānists. It would appear that Sahajayāna started with her. We would now mention Ḍombīheruka (777 A. D.) who is recognised as one of the 84 Siddhas and who wrote on Sahajayāna as well as Vajrayāna. In his work 'Sahajasiddhi' he formulates Kula worship from which come the words Kaulika and Kulācāra. Explaining the word Kula he says that Kulas* are five and originate from the five Dhyāni Buddhas and that the latter are called Kuleshas. This would suggest that Kaulas are Buddhists. The Kaulas declare themselves to be Tāntric Hindus. The meaning of Kula and Kaulas in Hindu Tantras is not definite. Although it may be an interesting inquiry whether the Kaulas are Hindus or Buddhists, yet there is practically no difference between the Kaulāchāra and the Tāntric Buddhāchāra.

+ The commingling of Śūnyatā with 'Karuṇā' is 'Advaya' in Vajrayāna. It is the foundation of Śakti worship amongst Buddhists. It is also deified. Heruka and Prajnā are the two deities in whom Śūnyatā and Karuṇā are personified. They are in embrace in the Yuganaddha or the Yab-Yum form.

* अक्षोभ्यो वज्रमित्युक्तं अमिताभः पद्ममेव च ।

रत्नसंभवो भावरत्नः वैरोचनस्तथागतः ॥

अमोघः कर्ममित्युक्तं कुलान्येतानि संक्षिपेत् ॥

Akṣobhya, Vairocana, Amitābha, Rātnasambhava and Amoghasiddhi are the five Dhyāni Buddhas called Kuleśas who started Thunderbolt, Lotus, Jewel, Disc (Cakra) and Action families.

Dombīheruka writes about Mahāsukha which can be had from one's experience. It has four successive stages viz. Ānanda, Paramānanda, Viramānanda and Sahajānanda. During the reign of king Mahīpāla 1st who flourished between 978 A. D. to 1030 A. D. there arose a group of powerful writers on Tantra, like Dipaṅkara, Advayavajra and others and that was the next period of Buddhist Tāntric development. The readers who are interested to know the aims and objects of Buddhist Tāntrics may refer to the learned introduction of Dr. B. Bhattāchāryya to Sādhanamālā.

We would here note that of the five kinds of Siddhis described in Pātanjalayogasūtrā: (जन्मौषधिमन्त्रतपः समाधिजाः सिद्धयः ॥४-१॥ the Siddhis aimed at by the Tāntrics are those obtained through the Mantras.) The eight great Siddhis of the Buddhists are different from those mentioned in the Yogashāstra.* The Buddhist's Siddhis are (1) Khadga, (2) Añjana, (3) Pādalepa, (4) Antardhāna, (5) Rasa-Rasāyaṇa, (6) Khecara, (7) Bhūcara, (8) Pātāla. The six rites or Ṣaṭkarma according to Buddhist Tantras are:— Śānti, Vashīkaraṇa, Stambhana, Vidveṣaṇa, Uccāṭana and Māraṇa, practically the same as mentioned in other classes of Tantras.

The Sādhanā of Śuklakurukullā at page 368 ff, mentions the different mental conditions and the dates of the month and the directions to be faced for the due performance of Ṣaṭkarma. The deity worshipped for the different rites though same will have different forms, colours and weapons according to the rules regulating the same. Appropriate directions, time, manual gestures (Mudrās) seats and modes of applications of Mantras for the different rites are prescribed also in the work here published.

According to Dr. B. Bhattāchāryya, the Mantras of Vajrayāna seem to be a development of the Dhāranīs contained in the Vidyā-dharapīṭaka mentioned above. The Dhāranīs existed in Buddhism from very ancient times and seem to have been devised for those Buddhists

* The eight Siddhis of Yoga viz, Añimā and others are covered by the Vaikriya Labdhi (i. e. Siddhi) of the Jains. See 'Senaprasāna' p. 76 Answer to question 276.

who cared more for their material welfare than Nirvaṇa. They could not read the Sūtras and so they were shortened into Dhāranīs for being memorised. When further shortened the Dhārnīs were reduced to Mantras which were sometimes reduced to a single syllable in the form of Bīja * as in the case of Prajnāpāramitā.

HINDU MANTRIC SYSTEM

(Dr. B. Bhattāchāryya infers Hindu Māntric system to be later than the Buddhist Vajrayāna and even that it was incorporated bodily into Hinduism from Buddhism, because he thinks Tāntric Mantras make abrupt appearance in Hindu Tāntric literature without showing even a faint trace of the earlier and crude stages of development. We beg to differ and point out that Hindu Tāntric literature has gradually developed from the Vedas specially the Atharvaveda. Besides what has been stated in the previous section hereof regarding Atharvaveda being the original source of Mantra as well as Tantra we beg to refer the readers to Āsurīkalpa in which according to the Mantra and Dhyāna there given the principal deity Durgā is addressed as 'Atharvaṇasya Duhite' and 'Turyavedasya Putrī' i. e. daughter of Atharvan. §

It is not only according to Hindu tradition or belief of Hindu Tāntrics that Atharvaveda is considered to be the original source from which Tāntrism is considered to have developed but also according to Jain authorities. We shall show this by references from two ancient Jain works viz. Vasudeva Hīndi by Vāchaka Śrī Sanghadāsa and

*Buddhist Mantras are of four kinds:--(1) Bīja Mantra being monosyllabic (2) Mūla-mantras are long and may be compared to Hindu Tāntrika's Mālāmantras (3) Hṛdaya Mantra being short Mantra for Japa of the principal deity i. e. Ishtadevatā (4) Āvaraṇadevatā Mantras being generally short Mantras of the deities surrounding the chief deity.

§ बालेन्दुभ्रुवेतवर्णां विकसितनयनां वामहस्तत्रिशूलाम् ।
दक्षे स्थाल्यंकुशाढ्यां हृदरुणवदनां नागयज्ञोपवीताम् ॥
नानालंकारयुक्तां सुललितवदनां तुर्यवेदस्य पुत्रीम् ।
दुर्गा पद्मासनस्थामखिलवशाकरीमासुरीं त्वां नमामि ॥

Sūtrakṛtāṅga Tīkā by Śīlānkāchārya. This Sanghadāsa is a Bhāshyakāra and is older than even the great Bhāshyakāra Shri Jinabhadraganikṣamāshramaṇa the author of Viśeshāvasyaka Bhāshya and Viśeṣaṇavatī. In his latter work he has mentioned the said Vasudeva Hiṇḍi calling it Vasudeva charita. We can therefore emphatically state that Sanghadāsa flourished prior to 6th century A. D. In his said work Vasudeva Hiṇḍi at p. 151 he has mentioned 'Mantra Niyogas' of Atharvaveda. (2) Similarly Śīlānka the commentator of Sūtrakṛtāṅga refers to Māntric practices of Atharvaveda meant for Abhichāra. See page 169 commentary Sūtrakṛtāṅga, Āgamodayasamiti Edition.

Not only the Vedas but also the subsequent Hindu literature comprised of Brāhmanas, Āranyakas, Upanishads and Purānas appears to have contributed to the development of Tantras.* We would first refer the readers to what Dr. B. Bhattāchāryya says about Vajrayāna at p. XXXVI of his Introduction to Sādhanamāla:—

“We can thus see that the Vajrayāna took into account all the good things, tenets, philosophical notions and theories, and *incorporated* all that was best in Buddhism and probably in Hinduism also, and it was owing to this that it attained great popularity.”

We would then refer the readers to the several quotations above showing the connection of Tantra and Mantra with Atharvaveda etc. and also the appendix II to 'Shakti and Shakta' by Sir John Woodroffe. We would also refer them then to the work in Gujarati by late D. B. Narmadashankar Mehta entitled “Shākta Sampradāya” which traces the Shakti worship through the different classes of literature beginning from the Vedas. The learned writer quotes the following 'Ṛik' in praise of Sarasvatī from Ṛigveda at the very start to show the existence of Goddess Sarasvatī in Vedic times: प्रणोदेवी सरस्वती वाजेभिर्वाजिनीवती । धीनामविभ्यस्तु ॥ (Ṛig. 10, 61,21). He states that the whole of the Vedas may be summarised in two words, 'Yajna' and 'Brahma'. 'Yajna' requires Anuṣṭhāna,

*Winternitz also says :—“On the other hand, some essential traits of the Tantras can be found as far back as in Atharvaveda, as well as in the Brāhmaṇas and Upaniṣads.” P. 605 History of Indian Literature.

while 'Brahma' thinking. He then states that Śaktivāda is connected with the Vedic Upāsanā Kānda. He then refers to the various Sūktas in praise of Aditi. She is said to be the mother of Gandharvas, Manushyas, Pitaras, Asuras and all Bhūtas. Śakti is here worshipped as Mother. She is also called Mahī or Prithvī, Sāvitrī, Gāyatrī and Sarasvatī. Aditi in short is also called Devatāmayī. In the Sūkta of Uṣādevī, Śakti is praised in the form of Virgin while Śakti in the form of Wife is praised in the Sūkta of Sūrya. Vāksūkta, (Ṛig. 10-26) and Laksmīsūkta in the appendix to Ṛigveda established worship of Śakti. Further references from Agnirahasyakānda of Yajurveda, Mantropanishad of the Śvetāshvatara branch, Chhāndogya Upanishad of Sāmaveda, Tāṇḍi branch, and Kāṭhaka Upanishad to Sūrya's wife, Prajnā alias Sphuraṇā, Parā and Devatāmayī Aditi respectively are given by the said writer in the first chapter of the said work. Vājasaneyī Saṃhitā refers to Ambikā (III-57) and Śiva (XVI-1). Then the said author traces Śaktivāda through Brāhmanas, Āranyakas, Upanishads and Vedāngas.

In Brāhmanas and Āranyakas, Śakti of Brahma is known by the name of Gāyatrī, Sāvitrī, and Sarasvatī. Gāyatrī is said to be Bhargamayī, Tejomayī and Jyotirmayī. She is called Sāvitrī as she gives birth to the universe. She is Sarasvatī as the current of joy (Ānanda) of Brahma flows from her. For full exposition of Gāyatrī, Gopatha Brāhmana (1-30-38), Brihad Āranyaka (7-14) and Maitrāyaṇī (Prapāthaka 5) are referred to by the said learned author. He further gives the information given below in Chapter II of his said work. He says that the roots of the technical Tāntric terms 'Bindu', 'Bīja' and 'Nāda' are to be found in the upāsanā portion of the Āranyakas. They are derived from 'Īkṣaṇa', 'Tapa', and 'Sarjana', of the Vedic literature, and are known as 'Icchā', 'Jnāna' and 'Kriyā' in Vedānta. This trio of 'Bindu' 'Bīja' and 'Nāda' is represented by a triangle with a dot in its centre and is known as 'Traipuradhāma'. Here 'Bindu' is first divided into 'Parabindu' and 'Aparabindu' and the latter is subdivided into the said 'Trio'. The central dot is the 'Para Bindu' and the

three points by joining which the triangle is formed are the said 'Trio'. The deity presiding over this 'Traipuradhāma' is 'Tripurā' and the detailed and complete representation of it is 'Śrīchakra' and the Vidyā relating to it is 'Śrīvidyā'. The other names given to Tripurā in the Āranyakas are 'Subhagā' 'Sundarī' and 'Ambikā'. Kanyā, Kumārī, Kātyāyanī and Durgā are mentioned in Taṭṭirīya Āranyaka. Umā Haimavatī and Gaurī are equally well-known. The worship of this deity is set forth in Saubhāgyakānda which is considered to be a part of Atharvaveda. Some of the Mantras of this Kānda are to be found in Āranyakas in the rites relating to Yajna. Literally their meaning is applicable to the Yajnas, while in reality they relate to the worship of the deity. At page 158 of the said work the learned author says Buddhist Tāntrism is evidence of Buddhism having risen from Hinduism and having been ultimately mixed up with it. He also says that apart from Buddhistic Philosophy the Buddhistic literature relating to Vyahāra-dharma and ordinary rules of conduct was based on the Hindu Tāntric literature as the Hindu Tāntrics were not particular about Varnāshrama-dharma. Referring to the Buddhist Tantra Śrīchakra Sambhāra he says that worship of Śakti including Mandalas, Bija-Nyāsas, Mantras, Mudrās, Upachāras Abhiṣeka and Dhyāna as therein described follows Hindu Tantrashāstra, the difference being only in the name of the deities. He says that it would be clear to every critical person that a thing is not changed by being differently named. He further says that as there is extensive Brāhmanic Tāntric literature relating to Kālī and Śrīvidyā, there is extensive Buddhist Tāntric literature relating to Tārā. He says that among the Hīnayānistis also Maṇimekhalā is worshipped as the deity presiding over the sea and that there is reference to this deity in 'Mahānipāta' and 'Dasanipāta'. We may here translate the verse, rendered in Gujarāti by the said learned writer from a Tantra at page 81 of the said work, to show that worship of Śakti is universal:—
 "Maheshvaras call her Śakti, Sānkhyas Parā Prakriti, worshippers of the Sun Mahārājnī, Buddhists Tārā, Chārvākas Āshā, Pāshupatas Śantā, Jainas Śrī, followers of Brahma Śraddhā, Vaidikas Gāyatrī, and the ignorant

people Mohinī. Referring to the ten Siddha Vidyās, (all of whom are named as emanations of Durgā in Sivapurāna as already shown) the learned writer says that Kālī or Śyāmā is much worshipped in the Eastern India, Sundarī or Śrī in the Southern India, Bhuvaneshvarī in Utkala i. e. Orissa, Tripurā in the Western India but more known under the name of Ambikā and Tārā mainly amongst the Buddhists.

He mentions the fourteen following Upanishads to show the worship of Śakti in the Upanishad period: 1 Tripurā, 2 Tripurātāpinī, 3 Devī, 4 Bahvṛcā, 5 Bhāvanā, 6 Sarasvatīhṛdaya, 7 Sītā, 8 Saubhāgyalakṣmī, 9 Kālī, 10 Tārā, 11 Advaitabhāva, 12 Aruṇā, 13 Kaula, and 14 Śrīvidyātāraka. He, however, states that Kālī, Tārā, Kaula and Śrīvidyātāraka Upanishads are not traced to the Vedic literature and are later than the rise of Tāntrism. Of the Vedāngas he refers to Vyākaraṇa and its philosophy of 'Sphoṭa' which is Śakti of Brahma and says that the grammarians accept Vāk as Śakti of the soul.

Dr. B. Bhattācharyya states (p. XVIII Introduction to Sādhanamālā):

"The conception of Gods and Goddesses in the Pauranic literature was so very attractive that the Buddhists in later times could not help incorporating the idea of godhead in their religion; and when they actually did this they deified all important personalities of Buddhism together with the deification of a large number of Buddhist ideas and philosophical concepts along with a few purely Hindu gods such as Gaṇeśa, Sarasvatī etc."

Further Dr. Bhattāchāryya himself (at p. XII of his Introduction to Sādhanmālā) states, that the magical conception in India can be traced continuously through Ṛgveda, the Brāhmanas, Atharvaveda, Kalpasūtras, Dharmasūtras, Purānas, the Tantras, and the Pāncharātras.

We have already traced the development of Hindu Māntric system from Vedas downwards. We would now show its existence in Purānas which would show that when the Buddhists admittedly borrowed from Purānas some of the Hindu Gods and Goddesses and incorporated the idea of godhead in their religion, they could also draw upon the Hindu Māntric system contained therein. Further we would show by

references from the earliest available work of Buddhist Mantrayāna viz, Āryamañjushrīmūlakalpa itself the existence of extensive non-Buddhist Māntric literature and particularly the Hindu Mantras and Tantras. We leave it to be judged by the readers whether the evidence adduced proves the existence of ancient Hindu Māntric system or merely a magical conception and also whether it would be correct to state that “Tāntric Hinduism drew its *inspiration almost* wholly from Tāntric Buddhism.”

Dr. B. Bhattāchāryya in his Introduction to Guhyasamāja at p. XXXIV defining Tantra says:

“Now for the Tantra to be called a real Tantra there must be the element of Śakti in it. Without Śakti there cannot be a true Tantra or a Tantra *par excellence*.”

We may state, however, that even Manjushrīkalpa does not restrict the meaning of the term ‘Tantra’ in this manner. There it means only a systematised Mantrashāstra. Dr. B. Bhattāchāryya having not made matters clear in his Introduction to Sādhanamālā as to the connotation of the term ‘Tantra’ as used by him, there is likely to be some confusion. He seems to make a distinction between Tantras of Yoga and Yogatantra classes and others in his Introduction to Guhyasamāja at p. XXXII. He seems therefore to be aware of works which are termed Tantras but do not fall within his above definition.

PURĀNAS

Even if the term ‘Tantra’ is used in the special sense, references to such Tāntric deities with their Śaktis are found for instance in Kūrmapurāna. In the first Adhyāya Viṣṇu calls Śrī his Śakti.

इयं सा परमाशक्तिर्मन्मयी ब्रह्मरूपिणी ।

माया मम प्रियानन्ता ययेदंधार्यते जगत् ॥ श्लो० ३४

In Adhyāya 12 Shivā calls herself Śakti of Maheshvara. Not

मां विद्धि परमां शक्तिं महेश्वरसमाश्रयाम् ॥ श्लो० ४८

only that but in verse 88 of the same chapter Himvān describes her as being half the body of Sankara (Śankarārdhasharīnī). The same Adhyāya 12 includes Sahasranāma of Sivā which is one of the five

parts of a Tāntric Panchānga. The said hymn includes names of many of the Tāntric deities known at present. A very important reference is to be found in the same Adhyāya 12 verse 262 which mentions inter alia Kāpāla Bhairava Yāmala and Vāma shastras which are meant for deluding people, being of Tāmasī nature and opposed to Śruti and Smṛiti.

कापालं भैरवं ः त्रैव यामलं वाममार्हतम् ।

एवंविधानि चान्यानि मोहनार्थानि तानि तु ॥ श्लो० २६२

Similarly Garudapurāna describes Gārudavidyā in Adhyāyas 19 and 197 and worship of Tāntric deities such as Viṣṇu, Śiva, Sūrya, Ganesha, Hayagrīva, Durgā and Tripurā with Mandalas, Mudrās and Nyāsas. It also gives a Sahasranāmastotra and a Kavacha of Viṣṇu both being parts of a Tāntric Panchānga. It also gives Panchatattvas and Chakra worship though Panchatattvas known to the later Tāntrikas are not described.

Agnipurāna itself says that it contains all the Vidyās:— आग्नेये हि पुराणेऽस्मिन् सर्वविद्याः प्रदर्शिताः ॥ Adh. 383 v. 51. What is most important, however, for the present discussion is the fact, that 39th Adhyāya of Agnipurāna enumerates 25 Tantras, which conclusively establishes the existence of Hindu Tantras, contemporaneously with if not prior to Agnipurāna. The limitation of space at our disposal does not allow us to reproduce the said list or the other references given below. The 26th Adhyāya gives Mudrās and the 29th, 30th and 320th Adhyāyas describe Sarvatobhadra and other Mandalas. The 30th Adhyāya further describes 3 kinds of Dhyāna. Adhyāyas 42 to 68 describe characteristics of temples and idols of various Tāntric deities, their installation ceremonies including 'Utsava' as also Jīrnoddhāra vidhi i. e. repairing or reinstating idols. Then two kinds of Dikṣā are described: Samayadikṣā (Adh. 81) and Nirvāṇadikṣā (Adhs. 83 to 88). Ṣatkarmas

* पञ्चरात्रं च—इति पाठांतरम् ।

1 All references to Purānas are from the publications by Śrī Venkateshvara press, Bombay.

are described in Adhyāyas 137 and 138 and various Nyāsas in Adhyāya 145. It is significant that one whole chapter 293 is taken up in the description of the technical terms of Mantra (Mantraparibhāṣā). The 325th Adhyāya gives a Chakra called 'Siddhādyañshakathana' to ascertain whether a particular Mantra will be fruitful or not.

Nāradiyapurāna expressly mentions 'Tāntrikas' and Agamokta-vidhāna' (Adh. 88 v. 24 and 69). It calls the Māntric portion 'Mahā-tantra' in its contents (Adh. 97) as also at other places (Adh. 92 v. 21) and gives Mantras, their purification, Dikṣā rite and Kavacha and Sahasranāma stotras of Ganesha, Sūrya, Viṣṇu, Śiva and Śakti. Adhyāya 66 v. 59 mentions Tāntric Sandhyā. Adh. 91, vv. 37-38 contain Dhyāna of Umāpati i. e. Mahesha with Umā in embrace. In course of worship of Śri Ganesha Adh. 68 v. 17 mentions his Dhyāna in which he is accompanied by his Śakti and further on vv. 43-44 mention 'Tarpaṇa' of couples of deities. In Adh. 84 in course of worship of Bhuvaneshī worship of couples of deities is mentioned. Adhyāyas 64 to 91 are taken up with descriptions of Mantras, Kavachas (protective hymns), Sahasranāmas and Stotras of various Tāntric deities, and Mandalas, Mudrās, Nyāsas and Bhūta-shuddhi. It is very important that Adhs. 85 to 87 derive ten Mahāvidyās (8 of them being common with those in the current list of Mahāvidyās) thus: Vāk or Vāṇī, Kālī and Tārā as emanations of Sarasvatī; Bālā Tripurā, Annapurnā and Bagalāmukhī of Mahalakṣmī, and Chinnamastā, Tripurabhairavī, Mātangī and Dhūmāvātī of Durgā. This furnishes us with a link in the development of ten Mahāvidyās from 3 Śaktis viz, Brāhmī, Vaiṣṇavī and Raudrī. Taking this with the reference from Sivapurāna given in the previous part hereof showing that 10 Mahāvidyās emanated from Durgā and with three forms of Durgā in Durgāsaptashati we are able to infer oneness of Śakti in the beginning. It also shows how Vedic literature has contributed to the development of Śakti worship. The readers will also see that Tārā Chinnamastā and Kālī were not originally Buddhist but Hindu Tāntric deities. Finally we would mention Mārkaṇḍeya Purāna which contains the

famous Durgāsaptashati and state that the antiquarians consider it very ancient and its text untampered by interpolators.

Whatever view as to the date of each of these purānas may be taken it is certain that they are prior to the date when Buddhist Tantras according to Dr. B. Bhattāchāryya became known i. e. about 700 A. D.

NĀGĀRJUNA'S KAKṢAPUṬA

Dr. B. Bhattāchāryya says that Saraha, Nāgārjuna and others were chief masters to boldly and publicly preach the Tāntric doctrines. Now Nāgārjuna is said to have flourished cir. 645 A. D. He wrote a work named Kakṣapuṭa. This work is published in Calcutta in a collection named Indrajālavidyāsangraha and the above work is called there Siddhanāgārjunakakṣapuṭam. At p. 265 of the said work occurs the following passage which speaks for itself and shows the indebtedness of Nāgārjuna to Hindu Tantras styled Āgamas. It may be noted that it also includes Ātharvaṇa Mahāveda amongst the Āgamas consulted by him for composition of his said work Kakṣapuṭa. He also mentions Śankara as having described in times of yore various modes of attaining success in 'Vidyās' when asked by Pārvatī.

संसारे बहु विस्तीर्णे विद्यासिद्धिरनेकधा ।
 प्रोक्तवाञ्छङ्करः पूर्वं यदि पृच्छति पार्वती ॥
 अन्यैर्देवगणैः सिद्धैर्मुनिदेशिकसाधकैः ।
 यद्यदुक्तं हि शास्त्रेषु तत्सर्वमवलोकितम् ॥
 शाम्भवे यामले शास्त्रे (शाक्ते v.l.) मौले कौल्यडामरे ।
 स्वच्छन्दे वाकुले (लाकुले v.l.) शौचे (शैवे v.l.) राजतन्त्रेऽमृतेश्वरे ॥
 उद्गीशे वातुले तंत्रे उच्छिष्टे सिद्धशाबरे ।
 किंकिणी मेरुतंत्रे च काकचंडीश्वरीमते ॥
 शाकिनीडाकिनीतंत्रे रौद्रेऽनुग्रहनिग्रहे ।
 कौतुके शक्तितंत्रे² च निराकार³ गुणोत्तरे ॥
 हरमेखलके तंत्रे इंद्रजाले रसार्णवे ।

1 v.l. कालचंडेश्वरे 2 v.l. शाल्यतंत्रे 3 v.l. क्रियाकाल०

आथर्वणे महावेदे चाविके गरुडेऽपि च ॥
 इत्येतदागमोक्तं च वक्रत्राद्वक्त्रेण यच्छ्रुतम् ॥
 तत्सर्वं समुद्धृत्य दध्नी घृतमिवादरात् ।
 साधकानां हितार्थाय मन्त्रखण्डमिहोच्यते ॥

If the work *Kakṣapuṭa* said to have been composed by *Nāgārjuna* is the same as the one published—and there is none other known—the evidence seems to be conclusive as to the priority of Hindu *Tāntrikas* and the indebtedness of Buddhist *Tāntrikas* to the former.

MANJUŚRĪMŪLAKALPA

✓ Even stronger evidence is furnished by *Manjūshrīmūlakalpa* of the ancientness of the Hindu Tantras and Mantras.

Dr. B. Bhattāchāryya says about this work in his Introduction to *Guhyasamāja* that it treats of the Māntric texts of *Manjushrī Kumārabhūta* several times designated therein as *Kārttikeya*. He is introduced with 'several Śaiva but non-Tāntric deities'. It contains practices for obtaining long life, health and happiness and all desired objects. It is in the form of a *Sangīti* and includes dialogues between *Śākyamuni* and *Kumāra Manjushrī* interspersed with queries by the Assembly of the Faithful. He further says:

"This work is very important for the history of the development of Tāntric ideals, tenets and practices, and provides a landmark in the process of their developments. In this work which has been rightly styled by Dr. Winternitz as a Tāntric work we find mention of a large number of gods and goddesses, several ancient works a large number of *Mudrās*, and descriptions of *Mandalas* with special directions for painting them and innumerable rites for attaining *Siddhis* or perfections."

"The names of *Amitāyus*, *Amitābha*, *Locanā*, *Ratnaketu*, *Vajrapāṇi*, *Avalokiteśvara*, *Māmakī*, *Ratnapāṇi*, etc. are mentioned but not in a systematic form,"

He considers the date of this work to be cir. 200 A. D. It is the earliest available work of Buddhist Mantrayāna.

We do not know why the Śaiva deities found in the work are said to be non-Tāntric. *Kārttikeya* alias *Skanda* himself is a Tāntric deity and so is *Śiva*.

Further there are specific references to Śaiva Vaiṣṇava and

Gāruḍa Tantra and Mantras of Śiva, Viṣṇu, Brahmā, Āditya, Gāruḍa, Mahalākṣmī and other deities of Hindu pantheon. There are references also to Laukika (popular) Mantras. This means that Mantras other than those of Buddhist origin called Laukika were prevalent amongst the masses. These must have had their origin in the Vedic literature.* Some time the author of the said work claims that even Laukika Mantras and those of Gāruḍa Tantra and others were promulgated by Bodhisattva. The reader will consider for himself what value should be attached to such claim. The description as Mantrasiddhas of a number of historical and illustrious Hindu personages, such as Arjuna and Asvatthāmā son of the famous Droṇāchārya of Mahābhārata fame amongst others (see P. 604 ff.) who flourished long prior to the birth of Lord Buddha, proves the existence and practice of the Hindu Mantras even in ancient times. The author of Manjūshrīkalpa, however, says that they practised one or the other of the Buddhist Mantras. It will be interesting to note that the said work contains a reference to Jain illustrious personages such as Ṛṣabha (first Tīrthankara of the Jains) his father Nābhi and son Bharata as Mantrasiddhas (see P. 609). The fact that this work calls itself a Tantra is of great importance in fixing the date of the origin of the Buddhist Tantras which will be about 200 A. D. or later if a later date is fixed for the composition of Manjūshrīmūlakalpa. Of course if one accepts Dr. B. Bhattāchāryya's definition of 'Tantra' this work may not in that sense be called a 'Tantra' but we prefer the evidence of the work itself and consider that 'Tantra' really means a systematised Mantrashāstra and not merely a work in which deities are accompanied by their Śaktis or where man and woman join in the worship of a deity. We do not consider it a necessary feature of a Tantra. It is only a peculiar

* "The great importance of the Atharvaveda-Saṃhitā lies in the very fact that it is an invaluable source of knowledge of the real popular belief as yet uninfluenced by the priestly religion, of the faith in numberless spirits, imps, ghosts and demons of every kind, and of the witchcraft." P. 129 History of Indian Literature by Winternitz.

feature of most of the Buddhist works since the time of Guhyasamāja.

Here are the references mentioned above:—

सर्वस्मिं (sic.) शैवतन्त्रे वै सर्वलौकिकचेष्टितैः ॥ पृ. ४६८
 य एव वैष्णवे तन्त्रे कथिताः कल्पविस्तराः ।
 उपाय वैनेयसत्त्वानां मञ्जुघोषेण भाषिताः ॥ पृ. ३४
 यावन्तः गारुडेतन्त्रे कथिताः कल्पविस्तराः ।
 ते मयैवोदिताः सर्वे सत्त्वानां हितकारणात् ॥ पृ. ३४
 मन्त्रा सिद्धिं न गच्छेयुः ब्रह्मस्यापि महात्मनः ।
 अनभियुक्ता तन्त्रेऽस्मिन् अदृष्टसमयोदिते ॥ पृ. ३६
 चर्या बोधिसत्त्वानां अचिन्त्या परिकीर्तिता ।
 सर्वमन्त्रेषु तन्त्रोऽयं अचिन्त्यतत्प्रभावतः ॥ पृ. ५५९
 रुद्रेण भाषिता ये मन्त्रा विष्णुना ब्रह्मणा स्वयम् ।
 तां (sic.) विच्छेद मन्त्रज्ञो विधिदृष्टेन कर्मणा ॥ पृ. ३६६
 आदित्यभाषिता ये मन्त्राः सौम्याश्चैव प्रकीर्तिताः ।
 ऐन्द्रा मन्त्रा प्रसिध्यन्ते पश्चिमे दिशि शोभने ॥ पृ. ३२६
 धनेन बद्ध्वा मन्त्रेण कार्तिकेयस्य युक्तितः ।
 यावन्तो लौकिका मुद्रा शैवाश्चैव सवासवाः ॥ पृ. ४९४
 त्वदीय कल्पराजे सर्वलौकिक लोकोत्तराणि च मन्त्रतन्त्राणि साधयितव्यानि ॥ पृ. १३०
 यावन्तो लौकिका मन्त्रा शैवाश्चापि सुपूजिता ।
 मन्त्रा गरुत्मने चापि सिद्धिहोमफलोन्मुखम् ॥
 सर्वलौकिकमन्त्रास्तु इन्द्ररुद्रोद्भवोद्भवा ।
 तेषु मन्त्रराट् सर्वे निबद्धा विधिहेतुतः ॥ पृ. ४६७

CONCLUSION

In view of the foregoing it would be clear to the readers that Dr. B. Bhattāchāryya is not right in saying that the Hindus readily incorporated many ideas, doctrines and gods originally conceived by the Buddhists in their religion and literature or that the Hindu Tantras arose only after the Buddhist ideas had established themselves.*

*“ It is, however, quite contrary to facts, when B. Bhattāchāryya (Sādhanamālā, pp. IXVI ff., IXXVIII) assumes that the Tantras first came into existence in Buddhism, and went over into Hinduism afterwards.” P. 401 History of Indian Literature by Winternitz.

Even the Tāntric Bīja Mantras such as "Om" "Hrīm," "Śrīm" "Bloom" "Aīm," "Klīm," "Saum" etc, are found in Sarasvatīrahasya Upanishad, as well as Tripurātāpinī Upanishad. The latter further contains Śrī-vidyā and many other Vidyās, Mantras, Mudrās, as also chakras (Yantras), the several rites for which they are prescribed and also over and above the Shāktamantras, the Mantras of Śiva, Viṣṇu, Sūrya and Ganesha. This will convince the reader about the antiquity of the Hindu Māntric system. We would cite here from Arthur Avalon's preface to the Buddhist Tantra Śhrī Chakrasambhāra, p. XXX :—

"With each fresh acquirement of knowledge as to Buddhism, it seems more difficult to separate it from the Hinduism out of which it emerged, and into which it relapsed."

This however should not be taken to mean that the Buddhist Tantras had no influence whatever on the Hindu Tantras. ‡ It is quite possible that Panchatattva worship originated in Tibet (known as Mahachīna) and was imported into India and influenced the practices of the Hindu Tāntrics. We are however not prepared to concede that because Vajrayāna has Yab-yum deities (i. e. deities in embrace), the worship of Kālī may have been of Buddhist origin. The reason is that worship of Kālī is very ancient in India and it is connected with deities described in Vedic literature such as Rātri (See Appendix II to Shakti and Shakta). Besides, the worship of Śiva-Śakti in the form of Ardhnārīshvara* or 'Sāmba-Sadāshiva' is to be found amongst Hindus from very ancient times. We have already mentioned the existence of worship of deities with their Śaktis in Purānas. In further support we would cite from the preface of Śhrīchakrasambhāra by Arthur Avalon:—

"The Shākta Tantra is also a form of Advaitavāda presented in a way suitable for its purpose, namely the practical end of worship. Therein Māyā is a Power (Shakti)

‡ "At this late period (when Tārā-rahasya of Brahmānanda was composed) it also occasionally happened that the Hindu Tantras were influenced by the Buddhist ones." History of Indian Literature p. 401.

* अर्द्धनारीश्वरो भूत्वा ययौ देवस्वयं हरः ॥ शिवपुराण, अ० १५ स्तो० ९

of the Supreme Consciousness. In Northern Buddhism, *as in Brahmanism*, the Bodhisattvas and Devatās are accompanied by their energies (nu-ma) in female form, the Deva being called 'Yab' and his Shakti 'Yum'." PP. XV and XVI.

EXAMINATION OF DR. B. BHATTĀCHĀRYYA'S VIEWS

According to Dr. B. Bhattāchāryya, the prefix or suffix 'Vajra' to the names of deities is in ninety cases out of a hundred a certain sign of their originating from Buddhism and where gods and goddesses are described as nude and lustful, they also must have had their origin in Buddhism. This is too sweeping a statement to be true. As regards deities whose existence can be shown to be prior to the rise of Vajrayāna the rule would certainly not apply, so the question always remains to be considered whether a deity having vajra in his or her name existed prior to the rise of Vajrayāna. At page 121 of Shree Ātmānanda centenary commemoration volume in his article entitled "Jain Iconography—a brief survey," following the same line of reasoning, Dr. B. Bhattāchāryya says, about Jain Vidyādevīs Vajrashṛṅkhalā and Vajrānkushi that they are clearly importations from the Vajrayāna school of Buddhism. If the learned writer had taken care to inquire whether these deities are to be found in any works older than the rise of Vajrayāna, he would not have fallen into this error. We would say that the test itself suggested to ascertain the origin of deities is so crude that the conclusions drawn from it are bound to be faulty. The learned writer being rather more familiar with Buddhist deities is easily led away to infer whenever he sees names either identical or similar to Buddhist deities in other pantheons, that the deities of the latter are really Buddhist. Even when he may not feel certain he ventures into such a statement as "Gandhārī also has a peculiar Buddhist odour." Now the names of all the sixteen Vidyādevīs including Vajrashṛṅkhalā, Vajrānkushī and Gandhārī* are to be found amongst other works in Nirvāṇakalikā by Śrī Pādaliptasūri,

*Gandhārī is one of the forty Vidyās named in Sūtrakṛtāṅga II, Sutra 2. We may state that Sūtrakṛtāṅga is one of the oldest Jain canonical works. See p. 164 Vasudeva—Hiṇḍi where also the name of Gandhārī occurs.

edited with an Introduction by the writer, which is a work of the first century of the Christian era according to him, and is taken to be not later than the second century by others. About the names of Māñibhadra and Pūrṇabhadra Dr. Bhattāchāryya has hinted—by saying that they will be familiar to a student of Buddhist Iconography as the two friends of Jambhala, the (Buddhist) God of Wealth—that their origin also must be Buddhist. Now the names of Pūrṇabhadra and Māñibhadra occur in Śrī Bhagvatīsūtra, ^x one of the most ancient and sacred canonical works of the Jains. One should not therefore be led away by similarity of names. Vajrayāna naturally stamped the deities it imported from other pantheons with the term Vajra as in case of Sarasvatī which is admittedly a deity of the Hindu pantheon. If therefore a deity without the term 'Vajra' is found in other pantheons and with the term 'Vajra' is found in Buddhist pantheon the natural inference would be that it is a Buddhist borrowing from one or the other pantheons.

Further the learned writer says Bhṛkutī is Buddhist. Granted that there is a deity named Bhṛkutī in the Buddhist pantheon, does it therefore follow that there cannot be a deity of identical name in any other pantheon unless it is borrowed from the Buddhist. For the matter of that there is a male deity as well as a female deity bearing identical name in the very list of Jain deities given by the said writer in his aforesaid article at pages 116–117. Does the learned writer suggest that although Bhṛkutī is a female deity in the Buddhist pantheon there cannot be even a male deity of identical name in any other pantheon. Now we shall deal with the fact that the said list of Jain deities contains also a female deity named Bhṛkutī. We shall

^xBhagavatī Sūtra, Śataka III, Uddeśa 8 p. 201 A. See also Āvaśyaka Chūrni p. 320 Ratlām Edn. and Trishashṭīśalākāpurushacharitra X Parva 4 Sarga vv 606–607 Āgamodayasamiti Edn. where it is stated that Pūrṇabhadra and Māñibhadra used to worship Śrī Mahāvīra every night during the particular monsoon. See also Vividhatīrthakalpa p. 70 where Māñibhadra Yakṣa is named.

apply the test given at page 142 of his Introduction to *Sādhanamālā* by the said writer himself, viz. similarity or otherwise of the Mantras of the common deities. The Mantra of Buddhist Bhṛkutī in *Sādhanamālā* is “ॐ भृं स्वाहा”. There is no independent worship of the male or female Bhṛkutī in the Jain pantheon and their Mantra as given in *Achāradinakara* is “ॐ नमो भृकुटये स्वाहा.” The Mantras being thus different, it puts a stop to further argument and it must be admitted that except accidental identity of names, there is nothing in common between the Buddhist and the Jain deity. Lastly there being no independent and detailed worship of Bhṛkutī current amongst the Jains there was no charm in borrowing a Buddhist name or deity. Further when a set of 24 deities is uniformly given in a pantheon and 23 of them cannot be even distantly shown to have Buddhist connection, how can it be imagined that merely one of them Bhṛkutī was borrowed. The Mantras and Svarūpas of Vajrashṛṅkhalā, Vajrānkushī, Gandhārī, Bhṛkutī and Māṇibhadra are given in *Nirvāṇakalikā* (pp. 3,28,35, and 37) and *Achāradinakara* Vol II (pp.155,157,162). As they are different from the Mantras and Svarūpas of the respective Buddhist deities of identical names it will convince the reader that there is no case of borrowing here.

We may now refer to two further statements made by Dr. B. Bhattāchāryya, for identification of deities. They are with reference to ornamental Mudrās and bearing of a miniature figure of one of the five Dhyāni Buddhas on the crown by a deity. We have nothing to complain against the statements as they stand. We want only to sound a note of warning that Mudrā, in sculptural Tāntric technique is particular disposition of hand and fingers; as such Mudrā aids to the grace and beauty of appearance, in describing any particular statue or idol, it may be described for instance as Jñānamudrāvibhūṣitā although Jñānamudrā is not an ornament. One should not merely because of the use of the word ‘Vibhūṣitā’ jump to the conclusion that an ornamental Mudrā is meant, and that therefore the deity described must be a Buddhist deity. Similarly if one can identify the miniature deity

borne on the crown of another deity as one of five Dhyānī Buddhas he may rightly infer that the particular deity is Buddhist. But one should not jump to such a conclusion merely because one deity bears another deity on the crown. The obvious reason is that in Jain pantheon also Lord Pārshvanātha is borne on the crown by Padmāvati in many representations and images. There is one other statement of Dr. B. Bhattāchāryya in his Introduction to Sādhanamālā (page 33) which we think is unwarranted. For his statement that the Jains borrowed to a certain extent the worthless and immoral practices enjoined in the Tantras (i. e. Buddhist Tantras) and that they could not throw them off even when Buddhism was stamped out of India, the learned writer has not cited any authority. We have already mentioned that Jain Tāntrism always remained free from Panchatattva worship. The learned writer proceeds further to attack all Sampradāyas calling them organisations for feeding worthless and idle priesthood, and outcome of superstitious belief. He explains that it was so because the Tāntric practices were attractive and the Indian people by nature superstitious. Elsewhere in his said article "Jain Iconography a brief survey" (published in 1936) he has stated:

"Such a varied and rich pantheon must necessarily presuppose the existence of widespread Tāntric practices amongst the Jains."

It would appear therefore that his said statement in Sādhanamālā about Jains borrowing worthless and immoral practices must be only a presumption. There being no such practices prevalent at any time amongst Jains, there is no question of their not being able to throw them off.

EARLIER AND LATER TĀNTRISM

In Sādhanamālā (Vol. I pp. 247 ff.) we would like to note there are Sādhanās of Jāngulī* for removing the effects of or preventing serpent-bites, which are in Dhāranī and Sangīti forms and ascribed

* See Vividha Tīrthakalpa, Śrāvasti Nagarīkalpa p. 70:—See Ibid p. 85.

to Buddha himself. Similarly the Sādhana (page 334 Sādhanamālā) of Vajrasarasvatī is also said to have originated from Buddha himself. It would appear therefore that the Sangītis, and Dhāraṇīs of Vidyā-dharapīṭaka are ancient Buddhist modes of Mantras. They seem to have arisen from the soil of Buddhist sacred literature. We also are inclined to agree with Śāntārakṣita and Kāmalashīla when they say that Mantras were propounded by Buddha himself for certain class of his followers. They must have however been in the form of Sangītis or Dhāraṇīs. † The later Buddhist Tāntric development is probably under the influence of Purānas and Hindu Tāntrikas, the Pancha-tattva worship being probably non-Indian. Later Buddhism developed into three grand divisions: Vajrayāna, Sahajayāna and Kālacakrayāna and several minor yānas such as Tantrayāna Bhadrayāna etc.

While concluding this section we may refer to a mystic practice even now current amongst Buddhists of Tibet as described by Alexandara David-Neel in her book entitled "With Mystics and Magicians in Tibet." It is the creation by concentration effected for months and even years on the tutelary deity-Ishtadevtā (called *Yidam*) of a phantom as a powerful means of protection. This is very similar to 'Dhyāna' prescribed in Mantrasādhana and the appearance of the deity worshipped to the Sādhaka whenever invoked. There also it is considered a creation of the mind of the Sādhaka. The book also refers to Kundalinī Yoga and Telepathy as practised by Tibetans even now.

† Winternitz says, having regard to the Chinese translation of Sukhāvātī (VIII, 33) made in the 2nd Century A. D., that Dhāraṇīs must be assumed to exist as early as that date, but that it is not possible to trace them to the early days of Buddhism, much less to Buddha himself. Ultimately, however, Dhāraṇīs were completely supplanted by Mantras. Amongst the later Mahayānasūtras the major portion of section II of the prose version of the Kāraṇḍa-Vyūha and Suvarṇa-Prabhāsa are in the style of Tantras.

Mysticism of Darvishes

MYSTIC consciousness comes to some naturally, to some sporadically, and to some by special training.

Mystic consciousness has been methodically cultivated by Hindus, Buddhists, Mohammedans and Christians says Prof. William James in his famous work 'The Varieties of Religious Experiences.' He says: "In India, training in mystical insight has been known from time immemorial under the name of Yoga. Yoga means the experimental union of the individual with the divine." The moral discipline and methods employed in the different systems teaching Yoga vary slightly.

Vivekānanda in his 'Rājayoga' says :

"That the mind itself has a higher state of existence, beyond reason, a superconscious state, and that when the mind gets to that higher state, then this knowledge beyond reasoning comes...All the different steps in Yoga are intended to bring us scientifically to the superconscious state or Samādhi...Just as unconscious work is beneath consciousness, so there is another work which is above consciousness, and which, also, is not accompanied with the feeling of egoism...There is no feeling of *I*, and yet the mind works, desireless, free from restlessness, objectless, bodiless. Then the truth shines in full effulgence, and we know ourselves...free, immortal, omnipotent."

"The Vedāntists say that one may stumble into superconsciousness sporadically, without the previous discipline, but it is then impure." Their test is empirical; its fruits must be good for life. When a man comes out of Samādhi, he remains "enlightened, a sage, a prophet, a saint, his whole character changed, his life changed, illumined".

Karl Kellner after carefully comparing the results of Yoga with those of the hypnotic or dreamy states artificially producible by us, says:—

"It makes of its true disciples good, healthy, and happy men By the subjection of his impulses and propensities to his will, and the fixing of the latter upon the ideal of goodness, he becomes a 'personality' hard to influence by others, and thus almost the opposite of what we usually imagine a 'medium' so-called, or 'psychic subject' to be".

Prof. William James says:—

"In the Mohammedan world the Sūfī sect and various darvish bodies are the possessors of the mystical tradition. The Sūfīs have existed in Persia from the earliest times, and as their pantheism is so much at variance with the hot and rigid monotheism of the Arab mind it has been suggested that Sūfism must have been inoculated into Islam by Hindu influences."

Quoting Sir William Jones, Brown the learned author of 'The Darvishes' gives the fundamental tenets of the Sūfīs as follows:—

"Their (Sūfī's) fundamental tenets are, that nothing exists absolutely but God; that the human soul is an emanation from His essence, and though divided for a time from its heavenly source, will be finally reunited with it; that the highest possible happiness will arise from its reunion, and that the chief good of mankind in this transitory world consists in as perfect an *union* with the Eternal Spirit as the incumbrances of a mortal frame will allow; that, for this purpose, they should break all connection (or *taālluk*, as they call it) with extrinsic objects, and pass through life without attachments, as a swimmer in the ocean strikes freely without the impediment of clothes."

Al-ghazzali a Persian philosopher and theologian, who flourished in the eleventh century, and ranks as one of the greatest doctors of the Moslem Church, says in his auto-biography as quoted by Prof. William James:—

"The Science of the Sūfīs aims at detaching the heart from all that is not God, and at giving to it for sole occupation the meditation of the divine being. Theory being more easy for me than practice, I read (certain books) until I understood all that can be learned by study and hearsay. Then I recognized that what pertains most exclusively to their method is just what no study can grasp, but only transport, ecstasy, and the transformation of the soul. How great, for example, is the difference between knowing the definitions of health, of satiety, with their causes and conditions and being really healthy or filled . . .

The first condition for a Sūfī is to purge his heart entirely of all that is not God. The next key of the contemplative life consists in the humble prayers which escape from the fervent soul, and in the meditations on God in which the heart is swallowed up entirely. But in reality this is only the beginning of the Sūfī life, the end of Sūfism being total absorption in God. The intuitions and all that precede are, so to speak, only the threshold for those who enter. . . . The transport which one attains by the method of the Sūfīs is like an immediate perception, as if one touched the objects with one's hand."

The original sects of the Sūfīs, it is stated in Malcom's History of Persia are two: the Hūlūlī or the 'Inspired', and the Ittihādīā or the 'Unionists'. Five branches grew out of these viz. (i) Wusūlīā or the United (ii) the 'Āshiqīā or the 'Loving' (iii) Talqīnīā or the 'Learned' (iv) Zurīqīā (or Zāqīā) or the 'Penetrating' (v) Wāhidīā much resembling the Ittihādīā the Unionists, whose chief principle is belief in the Unity of the Deity. We shall say more about the Sūfī sects and Darvish Orders in the next section specially dealing with the subject.

The beginning of Sūfīsm is nothing else than pantheism as shown in the exclamation of Maulānā Jalāl-ud-dīn, addressed to his spiritual master,

"O my master, you have completed my doctrine by teaching me that you are God, and that all things are God".

The Sūfīs compared the creation and God with the rays of the Sun continuously darted forth and reabsorbed and the Sun and the waves of the sea and the sea or the Alphabet and ink with which it is written. Ahmad-ud-dīn, the disciple of the Shaikh Shublī who was contemporaneous with Murād II, was however condemned by a sentence of the *Ulama* to be skinned alive, for his teaching that the human soul absorbed in God, or mixed with him, just as rain does with the water of the sea.

Bāyazīd of Bustām, the founder of Bustāmis Order of Darvishes identified himself with the Divinity when he cried out "Glory to me! I am above all things!" Caliph Ali however only said: "I am the living and the speaking Qurān."

The spiritualism of the Darvishes having its origin in the religious conceptions of India and Greece differs in many respects from Islamism says John Brown, the learned author of "The Darvishes." He also says that the existence of Spiritual Principles of the Darvish Orders which existed in Arabia previous to the time of the great and talented Prophet of Islam cannot be doubted. He states further that there are some differences amongst writers of note mostly with regard

to the estimate placed by each of these upon the character and influence of the Darvishes in the Mussulman world. Muslim authorities including Iqbal Ali Shah, the learned author of 'Islamic Sūfism' however deny that Sūfism in its origin was in any way connected with or influenced by Aryan or Greek ideas and believe that sūfism is an expansion of the esoteric form of the religion of Islam. M. A. Ubicini in his letters on Turkey says :

"Two things must be distinguished among the Darvishes: doctrine and institution. The first is nothing else than the Sūfism which existed in the East long previous to the coming of Muhammad."

It is suggested by M. A. Ubicini that of the two great primitive sects existing before the Prophet Muhammad the *Meschaiouns* (*Musha'ioons*) or the walkers and the *Ischrachaiouns* (*Ishraqioons*) or the contemplatives the former was continued in *mutakallim*, or metaphysicians, and the latter in the *Sūfīs*. H. A. Rose, the editor of Brown's 'The Darvishes', adds however in a footnote that the *mutakallimūn* cannot be regarded as distinct from the *Sūfīs*, or as a school which taught any one definite doctrine.

Sūfism of the Darvishes has a strange analogy of doctrine with that of Vedānta, says Brown giving main details of similarity some of which are set forth below. The Sūfī doctrines are called 'tarīqats.' Brahma is the source and origin of all the pantheistic doctrines. Brahma is the Absolute Spirit and the Pure Being of Vedānta. It is the Living Being while the Darvishes contemplate "Hai wa Qayyūm" i. e. the "Living and the Eternal." According to Vedānta all except Brahma is Māyā. The Sūfīs speak of the '*alam-i-misāl*' or 'world of reality'—the '*alam-i-khiyāl*', the 'world of illusion'. The Śravaṇa, *manana* and *nididhyāsana* (audition, meditation and contemplation) are the '*Samā' murāqaba*, *tawajjuh* and the *Zikr* of the Darvish *tarīqat*. The *bodha* of the Brahman is the 'ilm' and the *Jnāna* is the *mārifat* of the Darvish, without which it is not possible to emancipate the soul. Brown says that all this points out the source and the origin of whatever is pantheistic and mystical in the doctrines of the Darvish *tarīqats*.

Dr. M. Hafeez Sayyid Mohamed in his Hindi article 'Sūfī's Sādhanā-mārga' in the Sādhanānka of the Hindi magazine Kalyāṇa, 1940 identifies 'Dhāt-e-Bahat' or Pure Essence of the Sūfīs with (Nir-guna) 'Brahma' of the Vedāntist. Just as Brahma manifests in the form of the world because of 'Māyā' which is non-different from 'Brahma'; so also it is through 'Sifāt' or Attributes in the form of the whole creation, which is non-different from 'Dhāt', that 'Dhāt' is experienced or realized. But all the same Māyā is not itself Brahma nor 'Sifāt' itself 'Dhāt'. An opposite illustration is that of fragrance and flower. Fragrance belongs to the flower but is not itself the flower. 'Sifāt' is a manifestation of 'Dhāt.' The soul or 'Rūh' is only a reflection of Amr-e-Rab (Directive energy of God) and therefore there is no difference between the souls.

Pure Dhāt is called by various names viz, Dhāt-e-Sadhaj or uncoloured Dhāt, Wujud-e-bahat or Pure Existence. Ghāib-ul-Ghuyub or the Unseen even in thought, Ghāib-e-Mutluq the Absolute Unseen, La Ta'ayyun or the Unlimited, Munqat'a-ul-Isharāt or the dropping of all indications, 'Ayn-ul-Kafur or the Fountain-Reality of camphor, Majhul-ul-Nath or the Undefined by attributes. The four suppositions in Dhāt viz. ilm (knowledge), nūr (light) wujud (existence) and shuhud (self consciousness) are essence itself and not superimposition on essence, just as Sat, Chid and Ānanda are the nature or essence of Brahma and not its attributes. Everything is a manifestation of the Deity, but not a Deity in itself; just as every beam of light is not the Sun itself, but a manifestation of the Sun. The Sūfīs explain the mystery of the Universe or the origin of things on this theory of Emanation (Tannazzulat or descent). This subject however falls within the province of Haqayiq (Greater Mysteries), and we are chiefly concerned here with Daqayiq (Lesser Mysteries) related to the mystical side of Sūfism.

Sirdar Iqbal Ali Shah says:—

"The Sūfī doctrine does not pretend to teach that provided all its tenets are observed, man becomes as God. On the contrary, this can never be. Man, by purging himself of all earthly desire and lust, rids the Heavenly spark in him of earthly things and is

able thereby to return to God the original nucleus. 'So that naturally man relieved of his earthbound ideas and weaknesses, realizes that the part of him which is God simply returns home.'

"Many of the words and terms used by the Sūfīs are not understood by the uninitiated. Perfume, for instance, is the hope of the Divine afflatus—Sleep, meditation or the perfection of God. Wine signifies devotion. The Sūfīs often speak of having drunk wine to insensibility. This is naturally misunderstood as it means so devout was their devotion to God that they were entirely under His influence. The tavern is the place of prayer. The tavern-keeper is the Spiritual Head or Leader. Beauty is only spoken of in order to show the perfection of God. Inebriation and drunkenness typify the abstraction of the soul for material things."

THE DARVISH ORDERS

According to Von Hammer there were twelve tariqs or orders of Darvishes existing prior to the foundation of the Ottoman empire as set forth below:—

- | | | |
|------------|--------------------------------|-------------|
| 1. Uwaisī | 5. Saqatī | 9. Qubrāwī |
| 2. 'Ilwānī | 6. Qādirī | 10. Shāzili |
| 3. Adhamī | 7. Rifā'ī | 11. Maulavī |
| 4. Bustāmī | 8. Nūrbakhshī or
Suharwardī | 12. Badāwī |

Twenty-four orders have been instituted since the commencement of the 14th down to the middle of 18th century of the Christian era. Of these later orders the Naqshbandīs and the Baqtāshīs and of the earlier orders the Bustāmīs trace their descent from Abu Bakr—us—Siddīq, the first Caliph and all the rest from the fourth Caliph 'Ali. The former are known as Siddīqiā and the latter 'Aliides or Alawīs.

It is said that thirty-seven years after (Hijrā) the 'Flight' or 'Emigration' of the Prophet, Archangel Gabriel or Jibrāil appeared to Uwais, a native of Karn, in Yaman, and commanded him in the name of the Lord to renounce, and to devote himself to a life of penitence. He had never met the Prophet but when in the battle of Uhud the latter lost two teeth, Uwais in his honour had all his teeth extracted. As Uwais had none for his Pīr or spiritual guide, all the Darvishes having no Pīr are said to belong to the order of Uwaisis. Both Abu—

Bakr and 'Ali had the prophet for their Pīr, not so Uwais. The latter was only 'Ashiq'-e-Rasul or the Lover of the Prophet.

The Shaikhs 'Ilwan, Ibrāhīm-ibn-Adham, Bāyazīd of Bustām, Sāri Saqatī and others following the example of Uwais founded the orders which took their names and laid down rules of discipline to be followed by the disciples. The most celebrated of such founders as the Pīr of the Qādirīs, named Shaikh Abdul-Qādir Gilānī (Jilānī) known as Sultan-ul-Auliā or 'the Sovereign of the Saints' and also as Pīr Dastagir.

We may state here that in earlier times the various orders of Darvishes were not known after the names of their founders but were merely explications of their tenets or principles e. g. Hulūlī and Ittihādī etc. We have already mentioned these and others in the foregoing portion of this section. In the footnote by Rose at p. 54 of Brown's 'The Darvishes' a list of 'Approved' (*maqbul*) Sects * and 'Rejected' (*mardūd*) sects is given. The latter mentions Hulūlī and Hallājī as rejected or *mardūd* sects. This sect of Hulūlī has long been extinct.

Sirdar Iqbal Ali Shah in his work 'Islamic Sūfism' says:-

"There are some sects, which are known as Sūfis; but which are removed from their inner Court like the *Mujassamiyyah* (the Corporealists), the *Hulūlīs* (Incarnationists), the *Tanāsukhis* (Transmigrationists)."

The first of these sects traces its origin to Abi Halman of Damascus; and the second, to Munsur Abul Ghayz Hallaj (who lived in Iraq and was a contemporary of Junaid).

Mansur used to say *Anal Haq* (I am the Truth). He simply there by meant that he was a manifestation of the Truth. Although the *fatwa* of Mansur's execution was also signed by Junaid, out of regard for the esoteric Shari'at, Junaid said 'Mansur and I are one and the same thing only madness has saved me, and reason ruined him.'

Husain ibn-e-Mansur, and Abu Bakr Shibli gave preference to *Ghāib* over *Huzur*; and so in their moments of ecstasy they gave out

* A detailed description of most of these sects and others is given at pp. 23-28 'Islamic Sūfism'.

such expression as "I am the Truth" ("*Anal Haq*"). "There is none under my cloak except God" (*Laysafi jubbati siwallah*). Others—and they are the vast majority—gave preference to *Huzur* over *Ghāib*, like Muhasibi, Junaid, Suhail and Mohamed bin Khalif. These latter are those who take care for this world as well as of the next.

"Ahmad ibn-e-Sabit and his disciples Ahmad ibn-e-Yabūs, Abu Muslim of Khorassan, Shaikh-ul-Ishraq and Omar Khayyam were the exponents of the doctrine of reincarnation basing their arguments on Suratul-Baqara 61-92, Suratul Maidah 55, etc. Druses, who were the followers of Darazi were also believers in it".

The Baqtashis, says Brown, believe in the *tanasukh*, a system of *metempsychosis*.

Although originating in Arabia the various tenets or principles of the *tariqs* or orders of the Darvishes gained prominence in Persia and Bukhārā. From thence they travelled into Turkey, Syria and Egypt and even along the shores of the Mediterranean, as far as Morocco, and in the East to India. Brown says:—

"There are many Darvish Orders in Bukhārā, nearly all of the Sunni, or orthodox kind, more closely attached to the dogmas of the Qurān and its Prophet than those of Persia, which are almost all Shī'a, and advocates of the Caliph 'Alī."

The people of Bukhārā have a strong sympathy with 'Othman, but they are, says Brown, particularly fanatic and hostile to all non-Mussulmans. Brown further says:—

"The Eastern idea that the spirit or soul returns to this world and lives again in a new body, long after the decease and decay of its primitive corporeal form, is held as true by many of the modern Shaikhs of Persia. With them the belief in the re-existence of the Imām Mahdī is stronger than among any other Muhammadans."

Amongst the Persian Darvishes there are two sects viz. 'Alī Illāhīs and Ahl-e-haqq. The former (known as Sabā'iyas) believe in the divinity of 'Ali, while the latter consider that every one may, by superior piety and love of God, become joined to Him or even become God. The readers will be able to identify these respectively with the 'Incarnationists' and the followers of Mansur mentioned above.

Of the various orders of Darvishes the most ancient and the greatest like 'Ilwānīs, the Adhamīs, the Qādirīs, the Rifā'īs, the Naqshbandīs, the Khalwatīs, etc. are considered as the cardinals. They call themselves the *usūls*, or 'originals' and call others the *furū'* or 'branches' signifying their emanation from the first. "The order of the Naqshbandīs and Khalwatīs hold however the first rank in the temporal line; the one on account of the conformity of its statutes to the principles of the ten first confraternities, and to the lustre which causes the grandees and principal citizens of the empire to incorporate themselves in it; and the other, because of its being the source of the mother society which gave birth to many others. In the spiritual line, the order of the Qādirīs, Maulavīs, Baqtāshīs, Rifā'īs, and the Sā'dīs, are the most distinguished, especially the three first, on account of the eminent sanctity of their founders, of the multitude of the miracles attributed to them, and of the superabundance of the merit which is deemed especially attached to them."

All these different orders of the anchorites have their convents called *takiās*, *khānqās*. and *Zāwiās*, spread over different parts of the country.

Although considered as mendicant orders, no Darvish is allowed to beg, especially in public. Baqtāshīs are an exception as they deem it meritorious to live by alms. Many however in imitation of Hājī Bektāsh their founder, make it a rule to live only by manual labour.* The surplus of the revenues of endowments to their order is distributed among the poor, or is employed in the establishment of private and charitable buildings. The Shaikhs and Darvishes are scrupulously attached to this inviolable principle of their order.

* The doctrine of *tawakkul* or 'dependence upon God' was carried to excess by the earlier sūfīs, but in later times instead the duty to live by practice of *Kasb* or art or industry was inculcated. Pīr Dastagir of the Qādirīs is considered in India a patron saint of industries in general. In India the chief orders require the darvishes to live by practice of *Kasb*.

Although in no wise bound by any oaths, all being free to change their community or order, and even to return to the world, each one regards it as a sacred duty to end his days in the dress of his order. They are imbued with the spirit of poverty, preserverance, deep humility and perfect submission to their superiors. They are seen moving about with the head bent and the most respectful countenance. "They never salute anyone, particularly the Maulavīs and the Baqtāshīs, except by the name 'Yā Hū' !

Brown says:—

"The adoration of the master replaces also for the Darvishes the worship of the Divinity; the end of the being no longer dwelt in the intimate union of the soul with the Creator, but in an absolute conformity to the thoughts of the Shaikh . . . Such is the first obligation, the only one so to speak, imposed on the Darvish, and expressed by, this species of mental prayer, called *rabūta*, (*rabitā?*) to which he is not less exact in the performance than the ordinary Mussulman is to his *namāz*."

We would here give short particulars of the founders of some of the important orders mentioned above.

Shaikh 'Ilwān died at Jedda in 766 A. D.; founded the 'Ilwānīs.

Ibrāhīm b. Adham died at Damascus in 777 A. D.; founded the Adhamīs.

Bāyazīd Bustāmī died at Jabal Bustām, in Syria, in 874 A. D.; founded the Bustāmīs.

Sarī saqatī died at Baghdād in 907 A. D., founded the Saqatīs.

Shaikh 'Abd-ul-Qādīr Gīlānī died at Baghdād in 1165 A. D. at the age of ninety years founded the Qādirīs.

Sa'id Ahmad Rifā'ī died in the woods between Baghdād and Basra in 1182 A. D.; founded the Rifā'īs.

Shahābud-Dīn Suharwardi died at Baghdād in 1205; founded the Suharwardīs.

Najm-ud-Dīn Qubrā died in Khwarazm in 1220 A. D.; founded the Qubrāwīs.

'Abd-ul-Husain (Hasan b. 'Abd-ul-Jabbār) Shāzilī died at Makka in 1258 A. D.; founded the Shāzilīs.

Jalāl-ud-Dīn ar-Rūmī Maulānā, called the Mullā Khunkār died at Qonia in 1273 A. D.; founded the Maulavīs, generally called the 'Turning' or 'Dancing Darvishes'.

Ahmad Badāwī died at Tanta, in Egypt, in 1276 A.D. founded the Badāwīs.

Pīr Muhammad Bahā-ud-Dīn Naqshband died at Qasr-i'Ārifān, in Persia, in 1319 A. D.; founded the Naqshbandīs. According to Rose the correct date of his death is 1388 A. D. but the order may be older. It is based upon the principles of the two original fraternities and particularly upon that of the Caliph Abū-Bakr.

Sa'd-ud-Dīn Jabrāwī died at Jaba, near Damascus in 1335 A. D.; founded the Sa'dīs.

Hājī Baqtāsh Khurāsānī, called the walī or 'saint' died at Kirshahr, in Asia Minor in 1357 A. D. founded the Baqtāshīs.

'Umar Khalwatī died at Qaisariā in 1397 A. D.; founded the Khalwatīs. It is one of the few orders which admit women.*

We now give particulars of some of the orders mentioned in the next section entitled 'The Darvish orders in India'. Shah Ne'mat-ul-lāh Walī is the title by which Shāh Nūr-ud-Dīn Yazdī is known. He was born in 1330 A. D. He founded the order of Ne'matullāhīs. He travelled widely and possibly visited Afghānistān. He died in 1430 A. D. Tīmūr sent him into an honourable interment at Māhun, in Karmān, says Brown.

Qalandar Yūsuf Andalūsī, a native of Andalusia in Spain, was for a long time a disciple of Hājī Baqtāsh, but having been dismissed from his Order on account of his haughty and arrogant character, he made vain efforts to be admitted into the Maulavīs, and ended by establishing the Order of Darvishes named after him Qalandarīs. × They

*In India all the four main orders viz. the Chistīs, the Qādirīs, the Suharwardīs and the Naqshbandīs admit women as *murīds* but they are not made Khalīfās or successors to *Pīrs* or Shaikhs.

× The Qalandars are not an Order, says Brown. A Qādiri Darvish was named Shābāz-e-Qalandarī, as also a Maulavī Darvish named Shams-ud-Dīn Tabrīzī Qalandarī.

have to be perpetually travelling about living on alms. The Qalandarīs are, in view of the treatment of their founder by the Baqtāshīs and the Maulavīs, antagonistic to them.

The Murādīs seem to be an off-shoot of the Naqshbandīs. The order may have been founded by Murād, 'the Syrian' who died in 1719 A. D., or by Abdāl Murād a companion of Hāji Baqtāsh in the 16th century A. D. In the latter case they may be an offshoot of the Baqtāshīs.

Haidariā were founded by Qutb-ud-Dīn Haidar, of Zaūsh near Nishāpūr in Khurāsān, early in the thirteenth century. They are closely akin to the Rifā'ī, and dance on fires. They also wear iron rings on the hands, neck, ears; and even elsewhere—in token of their vow of chastity.

Lastly we may mention the Gulshanīs founded by Ibrāhīm Gulshanī who died at Cairo in 1533 A. D. They are also called the Roshanīs from Dada 'Umr Roshanī, preceptor of Ibrāhīm Gulshanī. A sect bearing the name 'Roshanīs' had some vogue in North-Western India at or about the same period. Bāyazīd Ansārī an Afghān known as Pīr Roshan born in 1526 A. D. is noted in the Indian History as he and two generations of his descendants headed a formidable resistance to the Mughal power, inflicting at least one grave defeat upon it, and probably succeeding in preventing the complete subjugation of the Afghān hills by the Mughals. Pīr Roshan taught that Pīrs are supreme manifestation of God.

We would refer the readers interested in the details of the lives of the saints mentioned above to Brown's 'The Darvishes', Nicholson's 'The Mystics of Islam' and to 'Tazkirat-ul-Auliā' a Persian work or its Gujarati translation entitled 'Muslim Mahātmās'.

DARVISH ORDERS IN INDIA

Sayyid Mohamed Hafeez considers that the Oldest Darvish Order in India is the Chishti Order which traces its origin to Khwājah Abu Abdāl Chishti who died in 966 A. D. It was introduced into India by Khwājah Mu'in-ud-Din Chishti of Sistan, a southern district of Afghānistān, where he was born in 1142 A. D. He went to Khurāsān and

thence to the neighbourhood of Nishāpūr near Mashhad. There he became a disciple of Khwājah 'Uthman Chishti Hārūni. After twenty years' discipleship he performed a pilgrimage to Mecca and Medina and thence he travelled through Iraq and Persia in course of which he made the acquaintance of many Sūfīs such as Shaikh 'Abd-ul-Qādir Jilāni and Khwājah Qutb-ud-Din Bakhtyar Kaki. The latter became one of his disciples. At Baghdād he became acquainted with Najm-ud-Dīn Qubrā Shiahāb-ud-Dīn Suhrawardī and other famous sūfīs. He was known as Aftāb-e-Mulk-e-Hind. He came back thence to Herat, Balkh and Ghazni. In 1192 A. D. he came to Delhi with the army of Shihāb-ud-Din Ghuri. At the age of 52 in 1195 A. D. he went to Ajamer which became his permanent residence until his death in 1236 A. D.

Akbar's connection with his tomb at Ajamer is historical. He vowed that if he took the fort of Chitor he would walk on foot from Agra to the tomb of the holy man in Ajamer. The fort was taken in 1568 A. D. He made a similar vow before the birth of Jehangir in 1567 A. D. and for ten successive years he made an annual pilgrimage to it. His last pilgrimage seems to have been in 1579 A. D. The spiritual descendants of Khwājah Mu'in-ud-Din Chishti have been among the most famous Saints of India. Hazrat Nizām-ud-din Awliya* of Delhi was his great grand pupil whose spiritual descendants are called Nizāmis. Similarly his another great grand pupil was Hazrat Makhdum, 'Ala-ud-Din 'Ali Ahmad Sabir of Pirankalir (near Ruraki) whose spiritual descendants are called Sabiris.

Qutb Minar at Delhi according to some is named after Kwājah Qutb-ud-Din friend and pupil of Mu'in-ud-Din. Both died in 1236.

*Both Khiljis and Tughlaqs were closely connected with him. The proverb 'Dilhi dūr-hai' i.e. 'Delhi is a long way off' arose out of his reply on being informed of Ghiyāsud-din Tughlaq's coming to get moneys alleged to have been deposited with him. Ghiyāsud-din died on his way by the fall of a house and never reached Delhi. Nizāmuddin died in 1325 A. D.

Nizām-ud-Din died in 1325 A. D., and Mukhdum 'Ala-ud-Din died in 1291 A. D. Nizām-ud-Din Awliya left as his khalīfah Nasir-ud-Din Muhamad, the Lamp of Delhi (Chiragh-e-Dilhi) who died in 1356. A. D. There followed a long line of saints in this order, who became so well known that the Chishtī fraternity spread far and wide. One of the most important of these later saints was Shaikh Salim Chishtī. He exerted a potent influence in the lives of the Mughul emperors and the royal families of his time. The emperor Jehangir was born in his house, and the saint himself lies buried in a beautiful tomb at Fatehpur Sikri.

During the two centuries following the death of Shaikh Salim Chishtī in A. D. 1572, the Chishtī movement experienced a period of decay, which became very marked by the middle of the eighteenth century. Towards the close of that century a revival of the order throughout the Punjab and Sind was led by Khwājah Nūr Muhammad Qiblah-e-'Alam, who was by ancestry a Rajput, and not of Sayyid origin, as had been the case of the former great leaders of the fraternity. Therefore, as Rose points out "it would seem that in a sense the modern rise of the Chishti sect marks an indigenous revival of Islam, under religious leaders of local tribes, instead of the older Sayyid families."

Another order found in India is that of Suhrawardīs. One of the sons or immediate descendant of Abūl Najīb brought his teaching to India. The Nizam of Hyderābād, says Rose, the Editor of Brown's "The Darvishes," claims spiritual descent as a murīd from Shiahāb-ud-Din, who according to Brown founded Suhrawardīs and died in 1206 A. D. According to another authority he was the founder of Nūrbakhshīs who are usually held to be identical with Suhrawardīs.

An offshoot of this Order of Suhrawardīs is the Indian Order of the Jalālīs ascribed to the saint Sayyid Jalāl-ud Dīn, a disciple of Bahā-ul-Haqq, the Suhrawardī of Multan. The Jalālīs have many curious practices. At initiation they shave completely the head, face,

and body, burn their clothes, and are branded on the right shoulder. They also wear glass bracelets like those worn by women. This order is regarded as one of the orthodox fraternities which conform to the Shara' or Shari'at.

Brown states that there is a Takīa at Constantinople for the wandering Darvishes of India which is called Hindīlar Takiasī. He also says that the greater part of the Darvishes visiting Constantinople belong to the orders of the Naqshbandīs, Qādirīs, Chishtīs, Kubrāwīs, Ne'matullāhīs, and Qalandarīs. Dr. M. Hafeez Sayyid Mohamed in his Hindi article on 'Sūfī Sādhanā Mārga' in the 'Sādhanānka' of the Hindi magazine 'Kalyāṇa,' mentions only the four Orders of the Naqshbandīs, Qādirīs, Chishtīs and Suhrawardīs probably because they are the major Orders in India. Even in Bombay over and above the said four Orders of Darvishes there are the orders of Rifā'iyā, Shāziliyā and Qalandariyā, the last however is not considered a distinct or regular Order. (See p.94 'The Darvishes'). Of course the Darvishes of the four orders firstly mentioned above are in majority.

There are also Darvishes belonging to other Orders or offshoots of the main Orders of comparatively lesser importance or without regular silsilā to be found in some parts of India. There are for instance Madāriyāhs who are followers of Zindā Shah Madār of Syria whose shrine is at Makanpur in Oudh. Then there are Sa'dīs Nūrbakshīs,* Murādīs, Shatāriās as well as Haidarīs. The writer is informed that sometimes at some places in India are found Darvishes of other Orders also, but generally they are wandering Darvishes only temporarily there.

It was through the missionaries of various Orders coming from beyond the North—Western frontier and from Iraq from time to time commencing from the close of the twelfth century of the Christian

*It is a branch of the Naqshbandīs and known chiefly in Kashmir. Sayyid 'Alī Hamdāni alias Amīr Kabīr Alī the Second, its founder, came to Kashmir in 1380 A. D. with 700 disciples, and died about 1386 A. D. at Pakhlī. He is known as the apostle of Kashmir. Nūrbakshīs said to be identical with Suhrawardīs are different.

era that Sūfī doctrines and practices have been chiefly introduced into India. Sirdar Iqbal Ali Shah says in his work 'Islamic Sūfism':

"Sūfism with its warm mystical yearning after union and fellowship with God, nowhere found a more suitable soil in which to thrive than India, where the very atmosphere was charged with a deep religious longing to find God, with the result that to-day it is estimated that fully two-thirds of India's Moslem population are under the influence of some one or other of the *darvish* Orders."

During the time of the Sultans of Gujarat many saintly persons came to Gujarat to propagate Islamic faith and settled there. Ten families of Sayyids, who so settled, are mentioned in *Mirat-e-Ahmadi*. Amongst them the Bukharī Sayyids Hazarat-e-Qutb-e-'Alam and his second son Hazarat-e-Shah 'Alam and their descendants became very famous and wielded great influence over the Sultans of Gujarat. The descendants of Shah 'Alam became known as Shāhiya Sayyids and those of his brother as Qutbia Sayyids. Shah 'Alam's title came to be publicly known through Shah Berek Ullah Chistī (the successor or Nizāmuddin Awliā of Delhi) thus:—Shah 'Alam was given by the latter a pot of baked beans to be carried home. On the way a deaf, dumb and blind drummer, who miraculously regained all his senses by Shah 'Alam's touch, announced him out of joy as Shah 'Alam by beating of his drum. The proverb thence became current that "the Chistīs baked and the Bukhāris ate." Sultan Muzaffar, who had several years before he became Sultan became a disciple of Qutb-ul-Aqtab Makhdum-e-Jahanian, grand-father of Qutb-e-'Alam, personally received the latter when he came to Pātan, in Gujarat, in 1399 A. D. at the age of 12 years. Both Qutb-e-'Alam and Shah 'Alam were great mystics. Many miracles are attributed to both of them. Shah 'Alam became particularly famous as visitors to him had their pockets mysteriously filled with money on their return. He was at the age of seventeen appointed the head of Maghrabia Order by Shaikh Ahmad Khattu called Ganj Baksh or Treasure bestower (who died in 1446 A. D.). Qutb-e-'Alam died in 1454 A.D., and Shah 'Alam in 1477 A. D. at the age of 63. Shah 'Alam's beautiful mausoleum can yet be seen at Ahmedabad.

The Sayyid families next mentioned are *Qādariyā* and *Rifā'īā* particulars of which have been already given in the previous section hereof.

Then come four families. Mashhadi Sayyids were sons of Sayyid Sharaf-ud-din, the son-in-law of Makhdum-e-Jahanian; they are buried at Broach. Tirmizi Sayyids were descendants of Makhdum Sayyid Yahya, successor of Makhdum-e-Jahanian. Makhdum Sayyid Yahya was buried outside Baroda. Bhaktari Sayyids were descendants of Sayyid Badr Bhaktari, another successor of Makhdum-e-Jahanian. Zaidia Sayyids were followers of Sayyid Usman, surnamed 'Sham'-e-Burhani', the eldest son of Qutb-e-'Alam.

Then come Idrusia Sayyids sons of Sharif Abu Bakr Idrūs, chief of Hadramaut in Arabia. He was buried in Jhaveri wādā of Ahmedabad. His descendants are found in Broach and Surat to this day.

The remaining two families are Shirazi and Arizi (Uraizi?) Sayyids.

Readers interested in details of the lives of these saints are referred to *Mirat-e-Ahmadi* published in G. O. Series, Baroda.

A number of Darvishes belonging to different religious orders introduced into India became influential guides of sovereigns, not only in spiritual but in political affairs as well. During life they enjoyed popular and royal favour; and after their death their tombs became places of pilgrimage for multitudes of devout Moslems.

"The *khānqāh* (monastery) exercises extensive influence for good or ill in the religious life of the Moslems of India who have elected to follow a spiritual guide, for the various *darvish* fraternities touch all classes, excepting those who have been influenced by modern education or extreme Wahhabi teachings.

"The effort to effect union of man's soul with God, which is deemed the highest bliss, is the chief function of the religious orders. Thus Sūfism has provided the objective or philosophy of life while it remains for the *darvish* orders to apply the philosophy to the every day needs of the man in the street."

One who guides a pupil for the purpose is called *Murshid*, *Shaikh* or *Pir* and the pupil *Murīd*. The pupil is a traveller (*sālik*) on the way (*tarīqah*). He is to be guided by the *Pīr* until he has advanced

through the various stages (*maqamat*) of divine illumination (*khatarāt*). Various orders of Sūfīs differ from one another in respect of the rules of meditation (*fikr*) and ritualistic observance (*dhikr*) prescribed for regulation of the divine illumination.

RELIGIOUS PRACTICES

Of the religious practices *dhikr* (remembering or reciting) has for its object the production of spiritual ecstasy (*Wajd*). It is of two kinds *dhikr-e-jali* (perceptible *dhikr*) and *dhikr-e-khafī* (imperceptible *dhikr*). There is a still further advanced *khafī* form in which the *Sālik* shuts his eyes, closes his lips and fixes his attention on his inhalations and exhalations. With exhalations he says “*Lā ilāha*” (There is no God) ... he annihilates all external objects and with inhalations he thinks he says ‘ill-al-lāh’ (except Allāh). A darvish thinks there is a still more advanced form of *dhikr-e-khafī*. Every person in his breathing consciously or unconsciously utters the name Allāh, the syllable “Al” being the natural sound produced by the incoming breath, and “lāh” being the natural sound of the outgoing breath.

In India the vociferous form of *dhikr* is frequently met with. The technique is uttering “*Lā ilāha*” he throws his head downward towards his right side and then bringing it back he throws it downward towards the left side shouting “ill-al-lāh”. As he proceeds his shouts become louder and his actions grow more violent, until finally, in utter exhaustion, he sinks back in a stupor, which is generally called a state of ecstasy (*wajd*).

Unlike the Naqshbandī Sūfīs Chishtīs enjoin upon their disciples to perform their recitations in a louder tone. Besides this there is a difference of technique between the parent Order of the Naqshbandīs and Chishtīs. Audition or *Samā’* is not only permissible in the practices of the Chishtī Order, but actually recommended.

From another point of view *dhikr* is of two kinds: one is practised alone and the other by a congregation or group. The first kind is already described. For the second kind, in India, meetings are usually

held on Thursday evenings; but there seems to be no such attempt to make public displays of them as is the case in Egypt at the present time, and as used to be the case in Turkey.

According to the early School of Sūfīs the Initiate must pass through our stages before he can gain reunion with God. Four veils obscure his sight one of which is removed at every stage until Perfection is attained. The first stage is humanity called *Hast*. The second is called *Tarīqat*, or the obtaining of potentiality. At this stage the disciple may lay aside all religious observances and think only on the delights of contemplation. The third stage is '*Arāff*' signifying a condition of knowledge akin to inspiration equalling that of the Indian yogi through 'Samādhi' or that of the angels. He now possesses occult powers. The fourth stage is *Haqīqut*-Truth. The utmost degree of purity and spiritual thought makes this possible; the man now becomes a saint. He can now commune direct with God, the Divine Sun of whom he is but a spark.

The Qādirīs, unlike the Naqshbundīs recite in a loud voice the names and attributes of God. There is practically no difference between the Qādirīs and Chishtīs. The method is two-fold; the recitation of God's name and the recitation of negative and affirmative Kalimā viz. confession of Islamic faith as to God's unity.

"The former is divided into four manners, the first being the recitation of the words, Allāh, Allāh, Allāh-God, God, God,—with utmost vigour and zeal, in a loud voice, till he becomes out of breath. Then he should tarry awhile and after regaining his breath the wayfarer should begin the recitation in the same way, and continue the process.

"The second manner is that he should repeat the word "Allāh" once over his right knee and then over his left knee while sitting in a knee-folded attitude of prayer.

"In the third manner he should proclaim the name of Allāh in a loud voice once over his right knee, then over his left knee, and the third time over where his heart is situated, sitting, as he may be, during the process, with his legs folded.

“Finally, in the fourth manner, the wayfarer should recite the name of Allāh once over his right knee, then over his left knee, and again over where his heart is and the fourth *Darb*, or Impact, should be vigorously pronounced just in front of himself.

“In the practice of Negative and Affirmative Recitation, the wayfarer should close his eyes, facing Mecca-ward, then begin the recitation of the sentence: *Lāilāh Illāllāh*- “There is no God except God” by starting the phrase *Lāilāh*- “There is no God-” from the navel bring it up to his right side where *Illal*-except-is to be uttered, and finally *Lāh*, to be carried to the left side where the heart is, and finished at that point. It is necessary, however, to concentrate upon the inner meaning of the Negative of all that is not God and in Affirmative of God’s Existence.

“The recitation in these manners, uttered in a loud voice, is considered to be conducive of concentration so that the voice of the Wayfarer should drown all other external voices and sounds that detract the attention; and it is further recommended that after the prayer of morning and late afternoon, the Brothers of the Order should sit in a circle in order to perform this recitation in a loud voice in the presence of their Spiritual Guide.

“Another spiritual exercise consists of reciting mutely: *Allāho-Samī*,’ *Allāho-Baseer*, *Allāho-’Alleem*-God hears, God sees, God knows all. The Sūfī should commence with the first name at the point of the navel, carrying the next name to the chest upward and finishing towards the sky with his head upraised. The process is to be repeated in its reverse direction and finished at the navel with the order of the names reversed. The spiritual excellence is reached through continual Meditation and Recitation of the above Methods.”

While concluding we shall quote Prof. William James’ remarks on the authoritativeness of the mystic consciousness.

“(1) Mystical states, when well developed, usually are, and have the right to be, absolutely authoritative over the individuals to whom they come.

(2) No authority emanates from them which should make it a duty for those who stand outside of them to accept their revelations uncritically.

(3) They break down the authority of the non-mystical or rationalistic consciousness, based upon the understanding and the senses alone. They show it to be only one kind of consciousness. They open out the possibility of other orders of truth, in which, so far as anything in us vitally responds to them, we may freely continue to have faith."

THE AULIĀ OR SAINTS.

The Darvish orders put full faith in all the grades of spiritually superior men and angelic beings. The former are termed Auliā or saints. They are designated "the friends of God who fear nothing." "They are those who among men are the nearest united to God, and who consequently enjoy His most intimate presence." "They are favoured with spiritual visions and apparitions, and frequent intercourse with angelic visitors, who appear to them in that semi-existence called a state of bodily slumber. In this world the saint hears the will of God, and in the other he understands it."

Khizr is called the chief of all the *awliās*, or saints. It is said that the *tarīqats* or paths, are Ali's, and the *sharī'at* or holy law, is the Prophet's. Sirdar Iqbal Ali Shah, the learned author of Islamic Sūfism says therein:—

"Walīs are those who are annihilated in their selves, and are an eternal in the beatific vision. There are always 4000 *awliya* in the world, who keep it going; of these, in the order of ascendancy, are 300 *akhyar*, and of these latter 40 are *abrar*, of these latter again, seven are *abdals*. Then 4 *autads*, 3 *naqibs*, and the head of them all is Qutub (the pole around which the existence turns), or Ghaus."

There is a *hadīth*, or traditional saying, of the Prophet: "If your hearts be oppressed with sorrow, go, seek consolation at the graves of the holy dead." Mussulmans in general pray at the tombs of those whom they consider reputed saints (Auliā), says Brown. They implore their intercession on their behalf. "Belief is also entertained that the souls of departed saints visit the graves where their material remains were entered: so that the way-farer, by blessing such souls, may receive spiritual guidance from the deceased saints by means of

meditation." "The doctrine of *Baruz*, in which the *rūh* of a departed saint could foster and cherish and guide the *rūh* of a living man was in favour with the Sūfīs. The *rūh* is neither within nor without the body; only its vision is on the body, the *rūh* of a departed "friend of God" could guide the *rūh* of a living man on whom it has fixed its vision."

Prayer is also offered at ordinary graves for the benefit of the soul of the deceased. If the deceased be in Paradise, the prayer is conveyed as an offering to the happy soul, if in hell it aids it out of that place of punishment. The practice, however, should not be confused with Grave Worship; for in Sūfism worship is only intended for One God and to no man excepting the Prophet Mohammed.

Many of the *takiās* of Darvishes are erected at, or even over, the tombs of eminently pious shaikhs, or other holy men. Much reverence is shown to them irrespective of the position the deceased may have held in the world. At many such *Dargāhs* lamps are kept burning as emblems of spiritual light shed around. Costly shawls and embroidered cloth are spread over them. With a view to procure relief, through their saintly intercession, from sickness, mis-fortune, sterility, etc. vows called *Nazr*, are offered up at them by visitors. Miraculous results are declared to have occurred at these tombs. Lights are often seen to float over them, or to lead to them.

MIRACULOUS PRACTICES

The spiritual exercises of those of the Order of the Rifā'īs embrace nearly all those of the other Orders. They excel others in these exercises. The Rifā'īs are the only ones who use fire in their devotions. It is in the last and ecstatic stage of their devotion called *Hālat*. Then they make use of red-hot irons. Even cutlasses and other sharp-pointed iron instruments are stuck by them with fury into their sides, arms and legs. Over the red-hot irons the Shaikh first recites some prayers and invokes the founder of the Order Ahmad-ur-Rifā'i, and breathes over them before delivering same to the Darvishes. The latter transported by frenzy, seize and gloat upon them tenderly, lick them, bite

them, hold them between their teeth, and end by cooling them in their mouths. All stoically bear up against the pain which they experience with apparent gaiety. Some time after this the Shaikh walks round and breathes upon the wounds of each of them, rubs them with saliva, recites prayers over them and promises them speedy cures. It is said that twenty-four hours afterwards nothing is to be seen of their wounds.

After the Rifā'īs, the Sa'dīs have also the reputation of performing miracles, pretty much of the same sort. To them are ascribed powers especially to handle snakes as they please.

Maulānā Jalāl-ud-dīn the founder of the Maulvī Order could through his spiritual power become invisible to ordinary sight, and would, when absorbed in pious and fervid love for Allāh rise upwards in the air and was more than once prevented from entirely disappearing from amongst his devoted companions only by means of music.

MAGIC

E. Rehatsek in a paper entitled 'Magic' published in the Journal of The Royal Asiatic Society, Bombay, 1879 says:—

"Spiritual magic is either licit or illicit, i. e. divine or Satanic; but there is yet a third kind, which, although it does not belong to the former, can nevertheless not be classed with the latter; most of its branches are however considered licit, and it has been called natural magic (or *Sīmya*).

Divine Magic—"There are also prayers, the recitation of which will procure the aid of genii, but everything is accomplished by appropriately uttering the great names of God. The *ineffable* name was engraved on the Seal ring of Solomon* (Sulaimān) and by means of it he subjected to his dominion not only genii and men, but animals and the powers of nature. This greatest name (Ism-e-a'zam) is revealed only to few holy men, and others must content themselves with the lesser ones,

* Muhr-e-Sulaiman i.e. Sulaiman's or Solomon's seal consisted of two inverted triangles forming the Tāntrik Ṣatkoṇa.

or even with those of the Prophet or the angels, which are also written together with verses from the Korān and used as charms in a variety of occasions. * * * Amulets, formulas or recipes against diseases, talismans, and the operations of a magic nature with prayers verses from the Korān, and invocations with great names belong to this branch, and some consider that even sorcery practised for benevolent purposes is a part of divine magic." Such magic is called *Ulwi* and all other magic *Sifli*. § The former derives its power from revealed Scriptures, God, His Prophet, or superior angels, while the latter derives its power from non-revealed texts and lower entities.

Satanic Magic—The 'Black Art' is called *Sehr*, and believed nearly always to depend on the agency of evil spirits. By means of enchantment or Sorcery persons may be afflicted with various kinds of diseases and harassed in various ways.

CHARMS AND TALISMANS

"They (Shaikhs and Darvishes) claim the power of interpreting dreams, and of healing, by means of spiritual remedies, both mental and bodily diseases. These remedies consist in exorcisings, and prayers" written on small rolls of paper and taken generally from the two chapters of the Qurān which refer to the work of malevolence, enchantments, witchcrafts, etc. Some invalids are asked to throw them into a cup of water, and drink the same afterwards, others are asked to carry them on their persons or in their pockets or to hang them around their necks for fifteen thirty or sixty days reciting now and then certain prayers. Some invalids are treated by the Shaikh or Darvish placing his hand on his head, making mysterious breathings on his person and touching the suffering parts. Not only to the sick but also to the healthy, as preservations against physical ailments—and even wounds

§ There are many Mantras current amongst the people generally as also amongst some of the Darvishes in which invocation with the name of God is mixed up with that with the names of Auliās, Pīrs, and other persons as also Hindu deities—such as *Janjī-ras* for self protection and others. All of them are considered *Sifli* by the Muhammedans.

of an enemy—also moral afflictions, are these rolls called *Nuskhās*, or *hamāils* (talismans) given, and the Shaikhs say they possess virtue only when given by their own hands, These often contain magic squares, *wifq*, or figures. They are retained by some on their person all their lives in small trinkets of gold and silver; others fasten them on their arms, or place them on the upper part of their caps or turbans, others again suspend them around their necks with a cord of gold or silk.

DIVINERS

Brown says that there is another class supposed by many to be Darvishes, but not really so-known as *Khavāsjar*. They are diviners though dressed like Darvishes and wearing green turbans. By means of *'ilm-e-ramal* and by cabalistic calculations, (generally of the numerical value of letters comprised in the names of parties concerned) and consultation of the four elements, *'anāsīr-e-'arba'* (to ascertain which of them predominates in the person's system) a *nuskhā* or charm is written out and delivered to the applicant. These *nuskhās* are composed of verses from the *Qurān*, to which is connected a belief of peculiar power in especial cases and are hung about the necks. They are sometimes not from the *Qurān* but are the original handwritings of certain highly reputed holy men. One kind of these writings is called *istikhārā* (seeking good; knowing what is best) and are placed under the pillow to influence the dreams of the sleeper or cause visits from benevolent spirits to the sufferer, and to respond to the wishes of the applicant. *Istikhārā* is according to some divination by means of *tasbīh* or rosary. It is attributed to one of the Prophet's wives. The diviner after repeating *Fātihā* (the opening chapter of the *Qurān*), breathes on the rosary in order to put the magic power of the chapter into the beads. Then he seizes a particular bead and counts towards the 'pointer' saying "God, Muhammad, Abu Jahal" or according to some "Adam, Eve, the Devil." If the count ends with Abu Jahal's name or the Devil's the omen is bad, if it ends with God's or Adam's the omen is good, in other cases doubtful.

ASMĀ-UL-'HUSNA

As amongst Tāntrikas Mantras are recited, so among the Darvishes and Mohammedans generally, the names of God are recited. Miraculous effects are attributed to them. Ninety-nine names of God are generally known, although according to Redhouse they may go upto a thousand and one (See also 'The Darvishes' p. 135). In the latter case they may be compared to 'Sahasranāma' and in the former to 'Śatanāma' well-known amongst the Tāntrikas. These names are called in the Qurān the *Asmā-ul-'husna* or 'excellent names.' These names are used as invocations, or as calls upon Him. The Moslems call them the *Asmā-ul-sifāt* or names expressing attributes. It is believed, these include the famous *Ism-e-Āzam* or His great name which has the most miraculous powers. The names are divided into two groups, the *Asmā-ul-jalāliya*, or 'awe inspiring,' and the *Asmā-ul-jamāliya*, or 'glorious' attributes, the former being the more numerous. Another more common division is into three classes, of wisdom, power, and goodness, each class containing thirty three names. The tasbīh-rosary of ninety-nine beads is also divided into three corresponding sections by oblong separators at which (separators) *Kalima* is repeated. Most people say 'Allāh' at each bead while some say the ninety-nine names or attributes of God one at each bead. The practice has its origin in the following verse of Qurān. "O believers (in the unity of Allāh, and the mission of His Prophet) repeat the name of Allāh, and count His names, night and morning". The rules of almost all darvishes* require them to repeat often during a day the seven first attributes of the Divinity. They call these attributes *asmā-e-Ilāhi* (Names of God). These are as follows:—

*The Qādirīs recite the following seven names:—(1) *La ilāha ill'Allāh*, 100,000 times, light blue (2) *Allāh*, 78,586 times, light yellow (3) *Ism-e-Hū*, 44, 630 times, light red (4) *Ism-e-Hai*, 20,092 times, light white (5) *Wāhid* 93420 times, light green (6) '*Azīz*, 74,644 times, light black (7) *Wadūd* 30,202 times, no light. See p. 106 'The Darvishes' for further information.

1. "Lā ilāh ill' Allāh ! (There is no God but Allāh), a confession of his unity.
2. Yā Allāh ! (O God), an exclamation referring to Him, the Almighty.
3. Yā Hū ! (O Him), He who is. An authentic acknowledgment of His eternal existence.
4. Yā Haqq ! (O just God).
5. Yā Hai ! (Ya Haiyo !) (O living God).
6. Yā Qayyūm ! (O existing God).
7. Yā Qahhār ! (O punishing God).

These seven attributes allude to the seven heavens called the *Sab'āsamā*, and the seven Divine lights, called the *anwār-e-Ilāhī* from which seven principal colours viz, white, black, red, yellow, blue, deep green and light green, are said to emanate. The initiation of Darvishes is generally by means of these mysteries. The Shaikh, that is the chief of the Order breathes thrice into the ear of the pupil each of these attributes in sequel but at interval of days months or years according to the spiritual advancement and disposition of the candidates. The full period is called *Chilla* and extends over several months and sometimes even more. The Shaikh in his capacity as spiritual guide is called *murshid* and the candidate during his novitiate is called *Kāchak* and thereafter *murīd*, (pupil). A reputed saint is commonly called *Shaikh*, *murābit*, or *walī*. The last correctly signifies a favourite of heaven, an eminent and very devout saint, but it is commonly applied to real or pretended idiots also. If he has reached the highest stage of union and is consequently forgetful of this world he is more properly termed *majzūb*, or *maslāb*.

The names of God as also prayers from the Qurān such as the famous Panj (five) Surāhs (chapters) and particularly Surāh-e-yāsin (considered to be the heart of the Qurān) and Āyats (verses) like Āyat-al-Kursi and Daruds like Darud-e-Sharif and others are recited several times and are considered to possess miraculous effects. It is considered that the veil is raised by reciting Darud-e-Sharif and the presence of God is expe-

rienced. The recitation of all *Amals* is preceded by and ends with the recitation of Darud-e-Sharif eleven times.

The 28 letters of the Arabic alphabet are believed to have mystical character. Each of the four elements has seven letters. Each of the letters has again distinct numerical value. This knowledge is used for divination, charms and certain occult practices as also medicine and chemistry. Each of the letters is believed to have a separate spirit attached to it—"a servant appointed by Allāh to attend upon it."

THE NAQSHBANDĪ ZIKR

Zikr is the union of the heart and the tongue in calling upon God's name Allāh. It commences with the recital of Lā-ilāh-ill'-Allāh-wa-Muhammad-ur-Rasūlullāh.

Zikr is recited in two ways: loudly or silently. The former is called *Zikr-e-Jehr* and the latter *Zikr-e-Khafī*. The practice has reference to the command of the Prophet to Abu-Bakr, the first Caliph, whilst concealed together in a cave, 'to recite the *Zikr* in silence,' so as not to be heard by their pursuers, and to 'Alī, the fourth Caliph 'to call loudly God's name without ceasing' to receive Divine assistance. The silent recital is however preferred by the Naqshbandīs. Eyes are closed, the mouth firmly shut, the tongue is pressed against the roof of the mouth, teeth held tight against each other, and retaining breath patiently in one respiration one should say *Zikr* three times with one's heart and not the tongue allowing thus the heart to be impressed with meditative *Zikr*. The object is to keep the heart occupied with the idea of God. It will be filled with awe, love and respect for Him. *Zikr* is said to be perfect if one is able even in the company of a crowd to continue to effect the same. A proper conception of the *tauhīd*, or 'Unity of God' is thus retained. The readers will remember that the Tāntrikas also consider mental Japa or the recitation of Mantras as the best. (See p. 83 ante).

KUNDALINĪ YOGA AND OTHER YOGIC PRACTICES.

Shaikh Ahmad, Naqshbandī mystic and the Mujaddid of the

eleventh century, "is the discoverer of six positions in the part of man's body between the neck and the navel, which he has called the six subtleties (Latayif-e-Sittah), one encircling the other, much after the manner of Kundalinī of Patanjali. The colour of *qulb* (heart) his yellow; of *soul* red; of *sir*, white; of *khafi*, black; and of *ikfa*, green. * * * * Some say that the colour of *nafs* is blue, and of *rūh* ochre. When the *nafs* entirely disappears, whiteness overshadows. The colour of soul often becomes green, the last stage is colourlessness, 'everything disappearing, and leaving the *Sālik* in a state of *fana*, the Transcendental wonder'-spoken of by Tennyson, which Sūfīs call '*Alam-e-Hairat*.* * * * The colour of the cloth, specially the head—dress, is indicative of the stage of the pilgrim's journey, e. g. if this cloth is of ochre colour, it means that his *sulūk* has reached the stage of *rūh*."

The Sūfīs, however, characterize *Nafs* with desire, *Qulb* with knowing, *soul* with sight, and *sir* with contemplating, and *Dhat* with appearing.

Dr. M. Hafeez Sayyid Mohamed in his article 'Sūfī's Sādhanā mārga,' already mentioned describes certain Sūfī practices which very much resemble Yogic practices:

Habs-e-Dam-Chishtīs and Qādirīs specially favour this, not so the Naqshbandīs. The latter do not consider it as absolutely necessary but consider it useful all the same. This is same as Breath-Control or Prāṇāyāma.

Shughl-e-Nasir (Nazr)-This is a meditative exercise specially recommended by Khwājah Mu'in-ud-din Chishtī. It consists in gazing on the tip of the nose without allowing the eyes to twinkle and imagining the 'Infinite Light' while sitting in a knee-folded position. In Yoga this is a Mudrā where Nāsāgra-Dṛṣṭi is kept up throughout Dhyāna.

Shughl-e-Mahmuda-In this exercise the practitioner gazes on the point between the two eye-brows until there is visualization of God in the heart. This is similar to the Yogic Trikuṭi practice in which during contemplation the eyes are turned upwards and gaze in the Trikuṭi.

Shughl-e-Saut-e-Sarmadi:-This exercise is similar to Yogic

practice in which the eyes, nose, ears and mouth are closed with both hands for ascertaining which *Tattva* viz, Earth, Water, Fire, Air or Ether (*Ākāśa*) prevails at any particular time. But here instead the contemplation is on *Ism-e-Dhāt* or the name of God and attempt is made to hear in imagination a sound as of water falling down from a higher place. Then actual internal sound is gradually heard. This sound is called in Yoga *Anāhata Nāda*. There is an exercise called *Sultān-ul-Azkār* (king of recitations) in which *Kumbhaka Prāṇāyāma* is practised; starting from navel saying 'Allāh,' the breath is taken to the head and retained there saying 'Hū' and the eyes are turned internally towards the heart. Another practice called *Zikr-e-Pās-e-Anṣās*, is to recite, with the breath, mentally *Lā ilāh* while inhaling and *Illallāh* while exhaling. This may be compared with Yogic *Ajapā Gāyatrī* in which 'Hamsah' Mantra is recited with breath i. e. 'Ham' while exhaling and 'Sah' while inhaling.

Tawajjuh as also *Zikr-e-Jehr* a special *Chishtī Zikr* and *Murātabā-e-Ism-e-Dhāt* are described by the learned writer. We would refer the curious reader to the original Hindi article.

SPIRITUAL POWERS AND THEIR DEVELOPMENT

"It is through the performance of the *Zikr*, by *Khalwat* (pious retirement for purposes of deep devotion) by the *tawajjuh* (or turning the face or mind devoutly towards God in prayer), by the *murāqaba* (or fearful contemplation of God), the *tasarruf* (or self—abandonment to pious reflection and inspiration,) and the *tasawwuf* (or mystical spiritualism), that the fervent *Darvish* reaches peculiar spiritual powers, called *quwwat-e-rāh-e-bātinī* (a mystical, internal, spiritual power). The life or biography, of every eminent *Shaikh*, or *pīr*, details innumerable evidences of this power exercised in a strange and peculiar manner. This exercise is called the *quwwat-e-irādat*, or the 'Power of the Will'. These powers are acquired by constant practice under the instruction and guidance of the *Murshid-ashāb-e-yaqīn* i. e. the spiritual preceptor (the 'Guru' of the *Tāntrikas*).

MURĀQBAH, INSILĀ AND TAWAJJUH

There are two spiritual conditons resulting from contemplation and prayerfulness: one is called *Murāqabah* and the other *insilā*. The former is an ordinary state of pious contemplation in wakeful moments when the senses are overpowered by the soul-force but the body and the soul are unseparated; the latter is the condition when the soul leaves the body and wanders about without regard to time or space. "It was in this latter (condition) that the Prophet is believd to have ascended in the spirit to heaven, borne there on an imaginary celestial animal, called the *Burāq*"—says Brown. Shaikh Muhyy-ud-Din al-'Arabī describes the *insilā* and also speaks of his having exercised fascination i. e. *habs-e-nazr* (meaning fixing of the gaze) and having arrested another until he obtained an answer from him so that the latter was unable to move at all until permitted to do so by the former. Ibn-' Isāī founder of the Order of 'Isāwīs explains in a work written by him the above phenomenon. *Tālib* signifies the Darvish or the active agent. *Matlāb* is the person desired to appear. *Mulūhaza* is the action of thought of the *Tālib** compelling the *Matlāb** to appear.

Tawajjuh is the producing of the person. *Ahl-e-hāl* is the person having power of making others appear. *Ahl-e-tasarruf* is the holy person possessing the power. *Hāl* is the state of ecstasy into which the person goes who makes the absent appear to him. *Hāl* is the condition of perfect submission of the person thus appearing to the power of the *Hāl*. *Shughl* is operation of the performance of this act of power. *Tasarwūr* is visualizing the *matlāb* in imagination.

Tawajjuh is produced in two manners: firstly by fixing one's gaze upon the heart of the *matlāb* and secondly not by looking at his heart but by praying to the Almighty. One must continue to pray with warmth and fervour until the *matlāb* finally appears. Then the *Tālib* blows as it were in the mouth of the *matlāb* reciting the invocation

* *Tālib* and *Matlūb* are the same as the *Sādhaka* and *Sādhya* of the *Tāntrikas*.

and arrests the *matlūb* by crying out his name simply and looking fixedly at his heart, reciting a prayer. Another *tawajjuh* is when the *Tālib* is desirous of bestowing something upon a *matlūb*, and he can then so influence the latter by his powers as to impress him beneficially. This is generally done to the *Sāliks* or neophytes under instruction by their *murshid*.

These powers are instances of personal magnetism and mesmerism or Thought-force.

SPIRITUAL POWERS

“Among the practices of these powers is the faculty of foreseeing coming events—of predicting their occurrence—of preserving individuals from the harm and evil which would otherwise certainly result for them—of assuring to one person success over the machinations of another, so that he may freely attack him and prevail over him—of restoring harmony of sentiment between those who would otherwise be relentless enemies—of knowing when others have devised harm against themselves, and through certain spells of preserving themselves and causing harm to befall the evil-minded; and even of causing the death of any one against whom they wish to proceed. All this is done as well from a distance as when near.

“In other parts of the world, and among other people, these attainments would have been attributed to sorcery and witchcraft; in modern times they would be ascribed to Spiritism, or magnetic influences, either of the spirit or of the body; but to the instructed Darvish they all derive the origin in the spirit of the holy Shaikh—the special gift of the great Spirit of God, which commences with the spirit of man from which it directly emanated. The condition or disposition necessary for these effects is called *hāl* the (state, or frame), and is much the same as that required by the magnetised, and the object of his operation. The powers of the body are enfeebled by fasting and mental fatigue and prayer, and the imagination kept in a fervid state, fully impressed with the conviction that such powers are really

possessed by the Shaikh, and that he can readily exercise them over the willing mind and body of the disciple. How the Shaikh can produce such strange results on a distant and unconscious person is left to the admiration and imagination of the faithful disciple, as an incentive to exertions in the same true path as that of his Shaikh.

“To exercise the power of the will, it is necessary to contract (concentrate) the thoughts suddenly upon the object designed to be effected, so perfectly as to leave no room for the mind to dwell, possibly, upon any other. The mind must not doubt, for an instant, of the success of this effort, nor the possibility of failure; it must, in fact, be completely absorbed by the one sole idea of performing the determination strongly taken, and firmly relied upon. The persons must, from time to time, practise this; and as they proceed, they will be able to see how much propinquity exists between themselves and the Hazrat-e-Asmā (God?) and how much they are capable of exercising this power,”

As an instance Brown quotes from Rashahāt (3rd maqṣad, 1st faṣl) the miraculous achievements of Maulānā Sa’id-ud-Dīn Kāshgarī and in particular his *taskhīr* or the subduing faculty making powerful princes to conform to his will and his powers to make his protégés victorious against heavy odds. He could “commune with persons widely separated from him, predict coming events, and aid those in whose welfare and success he felt a pious interest for good.” Similar is the instance of ‘Ubaid-Ullah, the Khwājah Aḥrar who caused murrain among Mirza Babur’s horses when he attacked Sultān Abū Sa’id at Samarqand; and caused a typhoon which caused the younger son of Sultān Abū Sa’id to raise the siege of Samarqand which was in charge of his elder brother Sultān Ahmad. The powers of Maulānā Sa’id-ud-Dīn Kāshgarī were connected with his prayers offered up to Allāh, to whose supreme will he attributed his powers. He constantly performed the *Zikr jehr* or ‘audibly called God’s name,’ and the frequent repetition fitted him for holy purposes. He had such mesmeric powers that he could, when he so desired, send an individual into a species

of trance, after which the latter could remember nothing that he had previously known, and continued in this state until the Shaikh chose to restore him to the enjoyment of his ordinary faculties.

The writer acknowledges this indebtedness to several Muslim friends for information on some of the points discussed in this section and to Mr. M. O. Kokil for use of some of his valuable books. The writer's thanks are also due to Mr. M. Y. Hainday, Advocate (O.S.), who was good enough to read through the whole section and make valuable suggestions. It may be stated that even when not expressly mentioned the writer has frequently drawn upon and adapted passages from the two very valuable books viz. 'The Darvishes' and 'Islamic Sūfism' and he acknowledges his indebtedness to the learned authors thereof.

Jain Mantravada and Caityavasis

MANTRAS and Vidyās* are said to have covered the whole of the tenth Pūrva entitled Vidyānupravāda+ of the fourteen Pūrvas forming the major portion of the Jain Canonical literature. These Pūrvas were very huge in volume and encyclopaedic in character. They are all lost now. According to the Jain tradition the whole of the Jain Canonical literature was comprised in twelve Angas× and the whole Pūrva literature was comprised in the twelfth Anga.† Only the first eleven Angas are now available as compiled by Śrī Devardhi Gaṇi Kṣamāśramaṇa 980 or 993 years after the Nirvāṇa of Lord Mahāvīra i. e. 454 or 467 A. D.

ŚRĪ PĀRŚVANĀTHA AND PŪRVA LITERATURE.

'Pūrva' means 'ancient' and the literature going under that name must therefore be considered to be older than the rest. The

*For all practical purposes Mantras and Vidyās are the same. A technical distinction is however drawn between them that in the former the presiding deity is a male and in the latter a female or that Sādhnā is strictly ceremonious in the latter but not so in the former. See Viśeṣāvaśyaka Bhāṣya and Āvaśyaka Nirukti V. 931

+ The commentary on Samavāyānga Adh. XIV explains Vidyānupravāda thus: "यत्रानेकविधा विद्यातिशया वर्ण्यन्ते तद्विद्यानुप्रवादम् । That is, Vidyānupravāda wherein are described many kinds of miracles caused by Vidyās (magic). The contents also of all the fourteen Pūrvas are there described. See also commentary on Nandīsūtra, Sūtra 56. According to the Digambaras the 10th Pūrva contained 500 Mahāvīdyās (great Vidyās) named Rohinī and others, and 700 Alpavidyās (small Vidyās) such as Anṅuṣṭhaprasena (questioning through the thumb) and others, and eight Mahānimittas or great omens or modes of divination. (See Introduction to Ṣaṭkhaṇḍāgama Vol. II p. 52 and Malliṣeṇasūri's Vidyānus'āsana Ch. III vv. 18-79.)

× See Samavāyānga Adh I for enumeration of the twelve Angas.

† Winternitz says the twelfth Anga contained only the remanants of the fourteen Pūrvas collected together at the Council of Pātaliputra about 170 years after Nirvāṇa of śrī Mahāvīra. (P. 432 History of Indian Literature Vol. II). The contents described in commentaries on Samavāyānga and Nandīsūtra however tell a different story.

writer considers that the term 'Pūrva' indicates that the substance of the literature going under that title really belonged to the age of Śrī Pārśvanātha which was prior to the age of Śrī Mahāvīra. Śrī Pārśvanātha was the 23rd Tīrthankara and Śrī Mahāvīra was the 24th Tīrthankara of the Jains. Śrī Pārśvanātha's Nirvāṇa was only 250 years prior to the Nirvāṇa of Śrī Mahāvīra. The parents of Śrī Mahāvīra used to worship Śrī Pārśvanātha.* We would refer those who might be inclined to doubt the very existence of sacred literature of Śrī Pārśvanātha's time to Śrī Mahāvīra's citation of a statement of Śrī Pārśvanātha to convince Śrī Pārśvanātha's pupils of the truth of his own statement as to the universe having innumerable '*Pradesas*' (parts) (See BhagavatīSūtra V Śataka, IX Uddeśa, 226th Sūtra.)⁺ Further it appears that in the Jain Scriptures and specially Śrī Bhagavatī Sūtra many Pārśvāpatyas or spiritual descendants of Śrī Pārśvanātha are described to be well versed in Nimitta Śāstra which belonged to the IX pūrva and some others like Muniandrācārya and Nandiṣeṇācārya are said to be 'Bahuśruta' i. e. possessing much sacred knowledge.× This goes definitely to prove the existence of sacred literature and specially Pūrva literature of the age of Śrī Pārśvanātha in the time of Śrī Mahāvīra. It may be noted that when the said Pārśvāpatyas are so described, Śrī Mahāvīra had not even commenced preaching having then not attained Kaivalyajñāna or omniscience. A most convincing proof of the existence of sacred literature including Pūrvas of the age of Śrī Pārśvanātha is furnished by the fact that

* See Āchārāṅga II śrutaskandha, Cūlā 3 Sūtra 401 "समणस्त णं भगवओ महावीरस्स भम्मा-पियरो पासावच्चिज्जा समणोवासगा याविहुत्था ।"

+ " से नूनं भंते अज्जो ! पासेणं भरहया पुरिसादाणीएणं सासए लोए बुइए अणादीए अणवदग्गे परित्ते परिकुडे इत्यादि " । पृ. २४८ भगवतीसूत्र

× It is believed that Rṣibhāṣita contains discourses by 20 Rṣis who flourished in the time of the 22nd Tīrthankara Śrī Ariṣṭanemi, by 15 Rṣis who flourished in Śrī Pārśvanāthā's time, and by 10 Rṣis who flourished in Śrī Mahāvīra's time. This is also evidence of the existence of older sacred literature.

Śrī Keśi Kumārasramaṇa a Pārsvāpatya (or a pupil of Śrī Pārsvanātha according to Uttarādhyayana) is described in Raypaseni an Upānga (See Sūtra 53, p. 118) as possessing knowledge of 14 pūrvas as also being prominent in the knowledge of Vidyās and Mantras. In Uttarādhyayana Adh. XXIII he is described as having reached the end of Vidyā i. e. sacred knowledge and possessing Avadhijnāna i. e. supersensual knowledge. Thus the Jain Māntric literature comprised in Vidyānupravāda may reasonably be supposed to belong to the age of Śrī Pārsvanātha.* This may perhaps explain the fact that amongst Jain Māntrikas Śrī Pārsvanātha is principally worshipped and invoked.

Several other facts showing the great popularity of Śrī Pārsvanātha's worship are set forth in the section hereof entitled 'Antiquity of Jain Mantras and Māntric literature'. These facts would also explain the popularity of worship of Śrī Pārsvanātha's attendant deities and particularly of Śrī Padmāvati with which the present work is concerned. One has only to consider the literary activities of the age of Śrī Pārsvanātha to find out an explanation for the fact that one whole Pūrva was devoted entirely to Vidyās. He lived from about 876 B. C. to 776 B. C. This was the period when many of the later Mantras of Atharvaveda are supposed to have been composed.* This

* According to the Jain tradition the sacred literature was substantially the same in the times of all Tīrthankaras. According to the following statement in Jnātādharma-kathāṅga the fourteen Pūrvas appear to have been studied also in the times of Śrī Ariṣṭanemi the 22nd Tīrthankara "तते णं से थावचापुत्ते अरहतो अरिदुनेमिस्स येराणं अंतिए सामा-इयमाइयाति चोइसपूव्वाइं अहिज्जति ॥" Jnātā V Sūtra 54. Kalpasūtra mentions that there were Sādhus knowing fourteen Pūrvas in the fold of Śrī Rṣabhdeva the 1st Tīrthankara as well as that of Śrī Ariṣṭanemi, Śrī Pārsvanātha and Śrī Mahāvīra.

* "The Surest evidence in this respect (for the age of the Veda) is still the fact that Pārśva, Mahāvīra and Buddha pre-suppose the entire Veda as a literature to all intents and purposes completed, and this is a limit which we must not exceed x x x we shall probably have to date the beginning of this development (of Vedic literature) about 2000 to 2500 B. C. and the end of it between 750 & 500 B. C. " P. 310 History of Indian Literature Vol. I Winterniz.

was therefore an age when Mantras were very popular. It is natural to suppose that being the heir apparent to the Kingdom of Kāśī, the ancient centre of Brāhamanic learning, he was influenced by his surroundings and contemporary literary activities and dealt with subjects of popular interest in the Jain literature composed by him or under his direction. Thus the whole of the tenth Pūrva came to be exclusively devoted to Vidyās and Mantras. That such a supposition is not far-fetched or fanciful can be seen from the fact that as mentioned in Kalpasūtra I, Sūtra 9 all the four Vedas including Atharvaveda Vedāngas etc. in brief the entire Brahmanical learning, it was prophesied by Śrī Ṛṣabhadatta, would be learnt by Śrī Mahāvīra. It means that Atharvaveda was not then considered as fit to be discarded as we see a tendency generally in the works of Vedic Hindus. This is also supported by the fact that the Brahmana ascetic Ārya Śkandaka is also described in Śrī Bhagavatīsūtra (II Śātaka, 1 Uddeśaka) as knowing all the four Vedas etc. including Atharvaveda; and, the said Śrī Ṛṣabhadatta is described as knowing the same in Śrī Bhagavatīsūtra, 1X Śātaka, 33 Uddeśaka.

UVASAGGAHARAM

Even Śrī Bhadrabāhu, the sixth pontiff, who died only 170 years after the Nirvāṇa of Śrī Mahāvīra, invokes Śrī Pārśvanātha in the hymn named '*Uvasaggaharam*' or Remover of calamities, and praises the Mantra * sacred to Śrī Pārśvanātha. This hymn is available and well known amongst the Jains and is considered a 'Smarāṇa' i. e. a hymn for daily recital. We may point out that the present work relates to the worship of Śrī Padmāvati who is an attendant deity of Śrī Pārśvanātha.

*The commentary on '*Uvasaggaharam*' of Śrī Pārśvadevagaṇi alias Śrī Candrācārya written in or about s. y. 1203 describes the said Mantra. It is "Namiūṇa Pāsa visahara vasaha jiṇa fulinga" It is therefore called '*Visahara fulinga*' Mantra in the 2nd verse of the said hymn.

MIRACULOUS WORKS

The following works which are with some variations enumerated in Ṭhaṇāṅga (X, 3, 755) Nandīsūtra (Sūtra 43, p. 202) and Vyavahārasūtra (X, 27-28) and Pakkhisūtra are said to be such that, when properly recited once twice or thrice, they cause, without the least desire on the part of the reciter, the deity described in the particular work to appear before the Sādhu reciting the same. The deity would then desire the saint to ask for a boon, which being not desired by him (he having renounced all desires), the deity would after making obeisance to him retire. The said works are:—(1) Aruṇovavāya (2) Varuṇovavāya (3) Garulovavāya (4) Dharaṇovavāya (5) Velandharovavāya (6) Veṣamaṇovavāya (7) Devindovavāya (8) Nāgapariyāvaṇiyā. There are other works viz. (1) Teyanisagga (2) Chāraṇabhāvanā (3) Āsīvisabhāvanā (4) Diṭṭhivisabhāvanā. (See Vyavahārasūtra X, 29) and Praśnavyākaraṇa* (different from the 10th Anga bearing the same name. See Nandīsūtra, Sūtra 54) by recital of which miraculous powers such as engendering fire or causing aerial flight or destruction by curse or gaze and answers to questions in various ways are obtained. Utthānasūya and Samutthānasūya are works by recital of which respectively houses, villages and towns become deserted, or are reinhabited when recited with that intention once, twice or thrice. All these works must have been very old as appears from their references mentioned above. They are however lost now.

PARŚVĀPATYAS AND NIMITTA

There is one more fact worth mentioning here which leads us to infer Śrī Pārśvanāth's connection with Mantras and Vidyās. In the available Jain Canonical literature 'Parsvāpatyas' or spiritual descen-

*A work of 400 gathās (with several commentaries named Līlāvati, Cūdāmaṇi, Jyoti and one without name) which may possibly be portion of Praśnavyākaraṇa mentioned here and which is called Jayaprābhṛta by Mr. C. D. Dalal through mistake—is still in a Pātaṇa Bhandāra written on a palm-leaf manuscript. See article entitled 'Āpaṇā Prābhṛto' by Śrī Kalyāṇavijaya—Jain Yuga I, P. 93.

dants of Śrī Pārśva are described at several places. Many of them accepted Śrī Mahāvīra's substitution of the five great vows instead of the four (Caturyāma) laid down by Śrī Pārśvanātha, after discussion either with Śrī Mahāvīra himself or his pupils. There were few however who did not like to give up the easy mode of life adopted by them and latitudes and liberties enjoyed by them. These latter consisted mainly of putting on coloured clothes and keeping bowls for begging, living in one place as long as desired and only occasionally performing 'Pratikramaṇa' i. e. Repentance for transgressions of the holy Law and the course of conduct laid down for a 'Sādhu' and employing eight kinds of *Nimitta** (Science of divination) for obtaining necessities of life. These continued to live by themselves practising *Nimittas*. It is recorded in Śrī Bhagavatīsūtra, Sataka XV, Sūtra 539 that Gosālaka (who was first a pupil of Śrī Mahāvīra but ultimately left him) met some of these Pārśvāpatyas and acquired such knowledge of the eight kinds of *Nimitta* (which is there said to be part of Pūrva literature) from them that he could pose as an omniscient person. Now some kinds of *Nimitta* require proficiency in *Vidyās* and *Mantras* for purposes of accurate divination. § The spiritual descendants of Śrī Pārśvanātha therefore knew and employed *Vidyās* and *Mantras*. This could not have been possible unless they were the possessors of traditional *Vidyās* and *Mantras* coming down from the time of Śrī Pārśvanātha. The Jain tradition as mentioned in the footnote at p. 149 definitely assumes existence of fourteen Pūrvas in the times of all the previous Tīrthankaras and therefore also of the 10th Pūrva dealing with *Vidyās* and *Mantras*.

NAIMITTIKAS, SĀRŪPIKAS AND SIDDHAPUTRAS

How these were succeeded in the practice of eight kinds of *Nimitta*, *Vidyās* and *Mantras* by Sārūpikas and Siddhaputras is a

* See post discussion on 'Angavidyā' and relevant *Vidyās* set forth in Appendix A.

§ The eight kinds of *Nimitta* are described in Sūryagadāṅga I, 12,9. The Commentary thereon says that the science of *Nimitta* is extracted from the 3rd *Vastu* (named *Ācāra*) of the 9th Pūrva.

problem of Jain history not yet solved. We find in the ancient literature like Nisītha—Bhāṣya I Udd. 'V. 346 and Bhāṣyas on Bṛhatkalpasūtra (I, IV and VI Udd.) and Vyavahārasūtra (IV and VIII Udd.) as also later Cūrṇis and commentaries including those on Āvaśyakasūtra, and Sambodhaprakaraṇa of Śrī Haribhadrasūri: references to Sārūpikas and Siddhaputras, who are described as versed inter alia in the science of Divination and accomplished in Vidyās and Mantras. The Siddhaputras are according to Nisītha Cūrṇi I Udd. Bhāṣya v. 346 said to occupy an intermediate stage between Jain householders and Jain Sādhus. Most probably they were Sādhus who reverted to the life of householders. The others, who though lax in the observance of the rules of conduct for Sādhus still continued to put on their garb and live by begging, were called Sārūpikas. They used to put on white garments but neither kept 'Rajoharaṇa' or sweeping brush, 'Danda' or stick, nor 'Pātra' or bowl, which the Sādhus keep. They used to have their heads completely tonsured or keep only 'Śikhā' or tuft of hair on the crown. They either lived alone or with their wives. They did not go about begging but earned their livelihood by practising various kinds of Śilpa (arts or crafts) Nimitta and Mantra and Medicine. When invited by Jain householders they would take their food with them as ordinary guests. The tradition of Aṣṭānaganimitta, Vidyās and Mantras appears to have been continued by this class for a long time. Even in the biography of Śrī Mahāvīra we read of Svapnapāṭhakas or interpreters of dreams. We also read

*Sārūpikas and Siddhaputras are described by Śrī Haribhadrasūri in his Sambodhaprakaraṇa at p. 3 thus : "The Sārūpikas practise Vidyās, employ magical collyrium and medicine and have attachment for certain families. They put on variegated apparels though tonsured on the head and face. They however, if asked, preach the correct doctrine about Jainism." Regarding Siddhaputras we cite the original verses below:—

“ससिद्धो समज्जगोवि य सिद्धपुत्तो सकूचिओ भणिओ ।

नो भिखइ सिप्पाइकम्मं काऊण जीवेइ ॥ ३३३ ॥

केविय भणंति पच्छाकटपुत्तो सिद्धपुत्तगो भणिओ ।

ससिद्धो वा असिद्धो वा समज्जगो वा भमज्जो वा ॥ ३३४ ॥

of a Naimittika named Utpala who though a Pārsvāpatya had turned a 'Parivrājaka' or non-Jain ascetic. He interpreted, unasked, to Śrī Mahāvīra, his dreams. This he did before Śrī Mahāvīra became omniscient and composed or directed to be composed the 12 Angas. The Nimitta literature known to him therefore was portion of the Pūrva literature coming down traditionally from Śrī Pārsvanātha. There was also a class of professional Naimittikas or diviners even in the time of Śrī Mahāvīra as can be inferred from the fact that Śrī Siddhārtha, the father of Śrī Mahāvīra, consulted and rewarded the Svapnapāṭhakas, as also from the fact that Naimittikas like Sivadatta used to be similarly consulted by the people. (See pp. 288–289 Āvaśyaka-cūrni on V. 479 of Niryukti). Pārsvāpatyas who did not accept the reforms of Śrī Mahāvīra and continued to enjoy liberties or turned Parivrājakas and the subsequent Sārūpikas and Siddhaputras[×] were not professional diviners but were very proficient in that science and utilized their knowledge as occasion required. They were however held in very great esteem by the people as their prophecies were considered to be infallible.

How the Māntric tradition was carried on by Caityavāsi Sādhus and in comparatively modern times by Yatis will be seen further on.

LAX PRACTICES CONTRIBUTING TO THE RISE OF CAITYAVĀSIS

We may however state that some of the principal characteristics of the 'Caityavāsis' can be traced back to very old times. They may be noted in such old works as Āvaśyaka Niryukti (V. 1107, VV. 1175, 1179–81) to be prevalent amongst some of the Sādhus of the times

× Kṣemankaragaṇi, a pupil of Devasundarasūri, of the 15th century of the Vikrama era, mentions in his Ṣaṭpuruṣacaritra (P. 10ff.) a Siddhaputra who derives his origin from Cakravarti Bharata, a son of Rṣabhadeva the 1st Tīrthankara, and says that these Siddhaputras were the best of Śrāvakas who observed the vows of the house-holders, led a celibate life, were versed in Mantras and Vidyās and were possessed of miraculous powers and supersensual knowledge, and were noted for their unshakable faith in and zeal for Jainism.

who were lax in the observance of the rules laid down for their conduct. These characteristics were 'Nityavāsa' or permanent residence, extreme attachment for 'Caityas' or temples, Kula, Gaṇa or Sangha and taking all kinds of rich food including sweets, ghee, milk, curds etc. and also food obtained through female ascetics. Similarly five kinds of lax Sādhus are also described who are said to be not deserving of obeisance. They are Pāsathhās, Avasannas, Kuśilas, Śaṃsaktas and Yathāchandas. Their lax practices also seem to have been later on followed to a considerable extent by Caityavāsis who also practised and employed Nimittas and Mantras. We think all these contributed to the rise of Caityavāsis. The other causes and circumstances contributing to their rise are dealt with further on.

PRĀBHṚTAS

We would here mention the Prābhṛta* works which are summaries from the Pūrva literature. The first person who appears to be connected with summarising or compilation of these works is Śrī Bhadrabāhu already mentioned. He might have composed these because he did not instruct his pupil Śrī Sthūlabhadra into the meaning of the last four Pūrvas and he therefore knew that knowledge of the Pūrvas would be lost in near future. As a matter of fact the last Āchārya who

* Prābhṛta was the term used to signify a chapter in Pūrva literature. Etymologically it is said to mean collecting something which may be lying scattered or a beautiful present. See also articles (in Gujarāṭi) by the writer entitled 'Alabhya Prābhṛto' in 'Jain yuga' Vol. III P.162-163 and Vol.V p. 161-162 and the articles entitled 'Āpaṇā prabhṛato' by Sri Kalyāṇavijaya in 'Jain Yuga' Vol. I p. 87 ff. and p. 127 ff. Vyavahārasūtra IV Udd. Bhāṣya V.12 refers to Pāhuḍa and the commentary interprets it as Yoniprābhṛta. The verse also mentions miraculous powers through Vidyās Nimitta etc. The Pāhuḍas or Prābhṛtas, important for our purpose, are Vijjāpāhuḍa, Siddhapāhuḍa Joṇipāhuḍa and Nimittapāhuḍa. They are all mentioned in Śrī Bhadreṣvarasūri's Kathāvali in the Prabandha of Pādaliptasūri as also in Prabhāvākacaritra. They respectively deal with (1) Vidyās (2) magical applications, collyrium, pills and powders (3) creation of insects and animals and (4) Divination through astrology dreams and other Nimittas.

knew even the ten Pūrvas was Śrī Vajraswāmi who died in s. y. 114. He as well as Śrī Pādaliptasūri are the next persons credited with further abridging or rearranging these Prābhṛta works. ×

The importance of these works is that there is a Prābhṛta named Vijjāpāhuda dealing with Vidyās mentioned in the biography of Śrī Pādaliptasūri contained in Kathāvali and also in Prabhāvaka-caritra works of the 13th and 14th centuries respectively of the Vikrama era. There, both the said Śrī Pādaliptasūri and Vidyācakravarti (Sovereign of Vidyās-magic) Āryakhapuṭācārya who flourished about the beginning of the Vikrama era are described as versed in Vijjāpāhuda. After Vidyānupravāda this Vijjāpāhuda was considered to be a comprehensive work on Vidyās and Mantras. It is however lost now.

Yoniprābhṛta referred to in the footnote on p. 155 is a work of the Prābhṛta class. An incomplete manuscript of the said work is available in a mutilated condition with many lacunae and mixed up with Jagatsundarī Yogamālā, a work on medicine by Muni Jasakīrti and/or Hariṣeṇa. Pahnasramaṇaṇuni is mentioned as the author of the said work Yoniprābhṛta in the said manuscript.* The writer has not personally seen the manuscript but has seen the notes taken therefrom by an acquaintance and a transcript of Chs. 35 to 43 from another incomplete manuscript also in the Bhāndārakara Research Institute Library. It contains Mantras at various places. At it is reputed to be an old work, some of the Mantras therein contained are set forth in Appendix A hereto.

× See Vividha-tīrtha-Kalpa, Śatrunjaya-Kalpa V. 122 and Revantagiri-Kalpa V. 1 and its colophon.

* The manuscript is in the library of the Bhāndārkar Research Institute and bears old No. 266/A 1882-83 and New No. 31. According to the colophon, the date of this manuscript is s.y. 1582 (Śaka 1447) Śrāvaṇa Kṛṣṇa 3rd. The work inter alia contains Mantras of Jvālāmālīnī and Kuṣmāṇḍīnī alias Ambikā, Māṇibhadra and Gaṇadhara-valaya Mantra. The last two are given in the appendix A hereto. Several articles on Yoniprābhṛta are published in Anekānta (Vol. II) a Hindi magazine published at Sarsāvā, Dist.Saliarānpur; they may be persued by the readers interested in the subject.

ANGAVIDYĀ

We have referred above to Aṣṭānaganimitta the eight-fold science of divination. One of its eight divisions is 'Anga' or Body. It means principally divination from throbbings in or touching the various parts of the body. The work which dealt with this part of Nimitta called Angavidyā is available. It contains several Vidyās, most of which resemble the famous Vardhamānavidyā which is said to have been separated from Gaṇabhṛd Vidyā alias Sūrīmantra i. e. Vidyā of Gaṇadhara or Mantra of Āchārya. Some Vidyās resemble the Sūrīmantra also. We shall have occasion to deal with the latter at some length later on. A few Vidyās are selected and given verbatim in the Appendix A. From its language Angavijjā seems to be a very old work.* One can see from the Vidyās cited that both Vardhamānavidyā and Gaṇabhṛd Vidyā alias Sūrīmantra also must be very old. The five Parameṣṭipadas may be noted in the beginning of Vidyās 1 to 3 and two at the beginning of Vidyās 4 to 6 set forth in the said Appendix A. They show the existence of Pancaparameṣṭi Mantra or Vidyā in olden times.

PANCAPARAMEṢṬI MANTRA

We think we should here explain that the Pancaparmeṣṭi Mantra contains obeisance to each of the five classes of revered persons: Arihantas, Siddhas, Achāryas, Upādhyāyas and Sādhus and the 'Falaśruti' i. e. narration of the fruit of such obeisance. It is said to be the destroyer of all sins and the chief Mangala or auspicious thing.

The greatest sanctity is attached to this Mantra. It is considered to be the essence of the fourteen Pūrvas and capable of giving worldly happiness as also ultimate salvation. It may be fitly called the Jain Gāyatrī and is meant to be daily recited morning and evening as also in all religious ceremonies and Pūjā or worship. It is

* Vārāhī Saṃhitā of Varāhamihira Adh. 51 deals with Angavijjā which is a method of answering questions relating to future or unknown matters by the gestures and position of the questioner and the words comprised in his question.

recited at the commencement of the reading of all sacred scriptures. It is considered to be the greatest Mantra and compared to the wish-granting gem-tree-pot-cow. It is said in Mahānisītha Sūtra, Adh. V that there were several Niryuktis Bhāṣyas Cūrnīs i. e. commentaries on the Panca-Mangala-Mahāśrutaskandha. Pancaparameṣṭi Mantra is said to have been extracted therefrom by Śrī Vajra-swāmi and incorporated in Mūlasūtra.* It appears in the beginning of Āvasyakasūtra (See the Cūrnī Edn.).

Angavijjā mentioned above belongs to the Prakīrṇaka or Payanno class of the Jain sacred literature. This class of work is believed to be the composition of Śrī Mahāvīra's pupils other than the chief ones called Gaṇadharas. We may however safely take this one to be not later than the first century of the Vikrama era that is the time when Śrī Vajraswāmi, the last person who knew all the ten Pūrvas flourished. It belongs to the time when summaries from Pūrva literature were being prepared.

We find from Prabhāvākacaritra that Śrī Vīraṅgi of the tenth century A. D. learnt Angavijjā from Śrī Vimalaṅgi and also acquired from him Gaṇavijjā alias Sūrimantra.

NIRVAṆAKALIKĀ

There is another work which though not principally dealing with Mantras throws considerable light on the Mantras and Māntric deities

* It is considered incorporated in all the scriptures—see Viśeṣāvaśyaka Bhāṣya V. 9. See also ibid v. 5:—

“कयपंचनमोकारस्स दिन्ति सामाहयाइयं विहिणा ।

आवसयमायायरिया कमेण तो सेसय सुयंपि ॥

There are hymns, Mantrakalpas and Rakṣā-Mantra relating to Panca-Parameṣṭi-Mantra. The importance of Pancaparameṣṭi Mantra in Vidyās and Mantras is that it must be recited at the beginning of all Vidyās:—

“सर्व विद्यास्मृतावादौ पूर्णा पंचनमस्कृतिः ।

यद्वा पंचनमस्कृतिः यद्वा पंचपदी वाच्या ॥

मुनिना प्रणवादिमा इत्यादि-सिंहतिलकसुरिकृतवर्धमानविद्याकल्पे श्लोक २२, पृ. ३

in olden times about the 1st century of the Christian era. It is Pādalīptasūris Nirvāṇakalikā already referred to in the section hereof entitled 'Buddhist Mantrayāna and Vajrayāna.' It contains daily rites, Māntric initiation and installation of idols and in course of treatment of the aforesaid subjects gives Mantras and describes various deities of the Jain Pantheon.

The chapters dealing with the daily rites and Māntric initiation are specially important as they describe the ancient Jain practices useful to the practitioners of Mantras. The work contains not only references to Sūrimantra and other Vidyās but at several places sets forth the same verbatim. This furnishes us a very useful test to ascertain the correctness of the tradition and the text of Mantras contained in Kalpas dealing principally with the subject. There are several Prākṛta verses quoted in the work as of Āgama which show the existence of Mantras in the ancient times.

VARDHAMĀNA-VIDYĀ

Now we come to the two works which are very old and deal principally with Vidyās and Mantras. We may first mention the Vardhamāna-Vidyā-Kalpa ascribed to Śrī Vajraswāmi who died in s. y. 114. It is comprised as Ch. III in Siṃhatilakasūri's work bearing identical name and appears to be a very old work on the sacred Vidyā of Śrī Vardhamāna Mahāvīra the 24th Tīrthanakara of the Jains, which is meant to be recited by all Sādhus daily, except Āchāryas who have to recite Sūrimantra instead, and also on all religious occasions viz. initiation, installation etc. It also refers to Sūrimantra and therefore proves the existence thereof in olden times. There is also a reference to Kalikunda-Pārśvanātha-Mantra and Vidyās of Mahānīśītha which proves the antiquity thereof. The other chapters of Śrī Siṃhatilakasūri's said work comprise Pancaparameṣṭi-Mantra-Kalpa and Ṛṣimandala-Stava-Yantra and other Mantras.

ANUBHAVASIDDHA-MANTRADVĀTRIMŚIKĀ

The next work is Anubhavasiddhamantradvātriṃśikā which is

published as appendix No. 30 in the present work. It is stated to be by Śrī Bhadrāguptācārya. But this Bhadrāguptācārya cannot be the preceptor of Śrī Vajraswāmi as in the body of the work, it is stated in the eighth verse of the first chapter that Vajraswāmi culled out from the third Prābhṛta (chapter) of Vidyāpravāda Pūrva (i. e. the 10th Pūrva so called) the Mantra mentioned therein. It can be ordinarily explained only on the supposition that the author of the work was later than Vajraswāmi. It does not however definitely exclude the possibility of Vajraswāmi's preceptor having written this work as he appears to have lived for several years after teaching the ten Pūrvas to Śrī Vajraswāmi. The author has in two places referred to Paramāgama or the great Āgama and Āgamamahāmbhodhi or the great ocean of Āgama (See Ch. III verse 30 and Ch. 1V verse 19): and he states that he has himself culled out the Vidyās mentioned in Ch. 1V from Āgamamahāmbhodhi. That the reference is to some Jain Āgama or canonical work is certain because the Vidyās mentioned are not known amongst non-Jains. One thing in Ch. V which pointedly draws our attention is that over and above gift of food, clothes and bowls gift of best gold is recommended to be made to the preceptor. This is a piece of evidence of Caityavāsi influence in very early times.

The reference to Setubandha in Ch. IV, V. 30 leads us to infer the date of the work to be subsequent to the composition of Setubandha mahā-kāvya i. e. 123 A. D. or (according to Cunningham) 432 A. D. (See discussion about the date of Setubandha in the footnote on P. 127 of Kavyamālā Vol. I and Indian Antiquary Vol. XII p. 243). Further the verse containing the said reference reminds us of a similar comparison by the poet Bāṇa at the commencement of Harṣacarita and in that case we must take the work to be not earlier than the 7th century A.D. It is possible however that the verse may have been interpolated by a later writer as it is not strictly required to be there by the context.

We shall consider this work in its other aspects further on and also show how the famous Hemacandrācārya has drawn upon it while

writing Chapter VIII of his *Yogaśāstra* dealing with *Padastha Dhyāna* i.e. *Mantra-Yoga*.

TĪRTHĀNUJNĀ AND VĀSAKṢEPA

We may draw our reader's attention to the ceremony with which Śrī Mahāvīra granted permission to his chief pupils called Gaṇadharas in respect of the Tīrtha, Dharma and Gaṇa. He is described as taking up a handful of scented powder from a tray held by Indra and dropping same first on the head of the first pupil Śrī Gautama and then on the heads of others saying to each "Permission is granted to thee in respect of the Tīrtha in all its various aspects." (See *Triṣaṣṭi Śalākā Puruṣa Caritra*, Parva X, Sarga 5, VV. 176-180). This ceremony is called 'Tīrthānujnā' and the dropping of scented powder is 'Vasakṣepa'. It was thereafter repeated on similar occasions accompanied by recitation of Sūrimantra composed by Śrī Gautama at the instance of Śrī Mahāvīra for such use in future. This is how Sūrimantra or Gaṇividya originated. *

SŪRIMANTRA

Amongst the Jains the Sūrimantra alias Gaṇivijjā is traditionally believed to have been handed down from preceptor to pupil from

* Śrī Munisundarasūri in his unpublished Stotra on Sūrimantra addressed the Sūrimantra as Tīrthakṛt, Tīrtha, Gautama and Sudharman and states that it originated through Gautama the leader of the gaccha under the direction of Śrī Vardhamāna :

“त्वं तीर्थकृत् त्वं परमं च तीर्थं त्वं गौतमस्त्वं गणभृत्सुधर्मा ।
 त्वं विश्वनेता त्वमसीहितानां विधिः सुखानामिह मंत्रराज ॥२॥
 श्री वर्धमानस्य निदेशतस्त्वं प्रतिष्ठितो गौतमगच्छनेत्रा ।
 सिद्धीः समग्राः शिवसंपदश्च सर्वोत्पुण्यफलानि दत्से ॥७॥

Śrī Jinaprabhasūri who flourished earlier also calls Sūrimantra to be the first cause of the emanation or advent of the Tīrtha in his *Siddhāntāgamastava* (*Kāvya-mālā* Pt. VIII P. 94)

सर्वश्रुताभ्यन्तरगां कृतैनस्तिरस्कृतिं पञ्चनमस्कृतिं ।
 तीर्थप्रवृत्तेः प्रथमं निमित्तमाचार्यमन्त्रं च नमस्करोमि ॥४५॥

Śrī Gautamaswāmi the first Gaṇadhara of Śrī Mahāvīraswāmi. Of course the tradition also connects it with the first Lord, Śrī Ṛṣabhadeva and his Gaṇadhara Śrī Pundarīka as shown further on. There are references to Sūrimantra in all the three works above mentioned, viz. Nirvāṇakalikā, Vardhamāna-Vidyākālpa as well as Anubhavasiddhamantradvātriṃśikā. The reference in the last named work is as Gaṇabhṛd—vidyā (See Chapter I verse 12). It states that it originated from the mouth of Gaṇabhṛd. The connection of Śrī Gautama with Sūrimantra* is amply evidenced by the hymn in praise of Sūrividyā published as Appendix 29 to this work. It also states that all the numerous deities presiding over Sūrimantra make obeisance to Śrī Gautama and worship his feet; and that Śrī Gautama should be contemplated as seated in a golden thousand—petalled lotus possessing miraculous powers and that one who repeats the Vidyā one lac times or the Mantrarāja three lac times would be another Gautama. This stotra is included in the work containing Devendrasūri's Sūrimantrakālpa† published by Śrī Prītivijayaji and ascribed to Śrī Māndevasūri. There is however nothing therein to connect it with Śrī Māndevasūri.

The Sūrimantra stotra by Śrī Māndevasūri (author of Laghu-śānti published in Appendix 31 of this work) is historically very important. It is, however, not yet printed. We therefore give it in appendix A hereto. At the end of it occurs the name of Śrī Māndevasūri as its author. It shows that Sūrimantra with all its five Pīṭhas or sections or divisions was practically the same in the time of Śrī Māndevasūri (3rd century of Vikrama era, he having died in

* Śrī Jinaprabhasūri in his hymn to Śrī Gautama refers to him as 'Vidyāmantraprabhava' or the source of Vidyās and Mantras. (Kavyamālā Pt. VIII P. 112).

† There are several Sūrimantrakālpas by different Āchāryas. One by Śrī Siṃhatilaka-sūri called Mantrarājarahasya is hereafter discussed in details. Two others by Śrī Jinaprabhasūri and some Āchārya of Pūrṇamīyaka gaccha have been published by Śrī Prītivijayaji which, perhaps because printed from a single manuscript, very much lack correction.

s. y. 261) as is known to us today. It proves the authenticity of the Māntric tradition.

According to a tradition contained in Sūrimantrakalpas including Mantrarājarahasya by Śrī Siṃhatilakasūri Sūrimantra is connected with the first Lord Śrī Ṛṣabhadeva also and it was in his time that Brāhmī became the deity presiding over the first Pīṭha known as Vidyāpīṭha out of the 5 Pīṭhas of Sūrimantra. The fact that the 2nd Pīṭha has Bāhubalividya included in it testifies to the tradition being correct, Bāhubali being the son and disciple of the first Lord, who ultimately became a Siddha. According to the said Mantrarāja-rahasya 1000 Vidyās* are comprised in the first Pīṭha; 20 Vidyās being comprised in each of the 50 Labdhipadas forming the first Pīṭha. It is stated there that by contemplation of those who are possessed of Labdhis (i. e. Miraculous powers of the soul) Vidyās are acquired by the worshipper. 1000 Mantras are stated to have been included in Mantrarāja Pīṭha and on attaining success by contemplation of the said Pīṭha 1000 Mantras automatically become Siddha i. e. accomplishment is acquired in respect thereof. The said Mantrarājarahasya with its commentary Līlāvati is a collection of Sūrimantrakalpas belonging to different gacchas and as such furnishes us the different versions+ of Sūrimantra in a single work. In the 50th verse of the said

* The number of Vidyās being 1000 can be seen from Aṣṭāpadagiri-Kalpa, p. 93 Vi-vidha Tīrtha Kalpa, where Rāvaṇa is said to remember 1000 Vidyās before he lifted up Aṣṭāpada mountain “विज्जासहस्रं सुमरित्ता उप्पाहीओ गिरी ।” That the small Vidyās are 700 in number can be seen from the following: “सप्तशतक्षुल्लकादि महाविद्याधिपते” at p. 19, Section dealing with Mantrāmnāyas of Śrī Namaskāra Mahāmantra in the work entitled “Mahāprabhāvika Navasmarāṇa”, by the present publisher. See also ‘Vidyā-nuśāsana’ by Śrī Malliṣenasūri Ch. III, VV.18-19. There the Mahāvidyās like Rohiṇī and others are said to be five hundred and the ‘Aṅgusthādi’ small Vidyās are said to be seven hundred by Śrī Malliṣenasūri.

+ The variations chiefly relate to the 1st and the 5th Pīṭha. In the former by inclusion of a lesser or greater number of ‘Stuti-padas’ or ‘Labdhipadas’ the Vidyā evolved is of 13, 16, 24, 31, 32 or 39 padas and in the latter the number of Merus being differently taken to be 5, 6, 7 or 13 causes the variation.

work it is stated that from the first Tīrthankara Śrī R̥ṣabhadeva to the eighth Śrī Candraprabha Vācanā or the text was the same but varied afterwards. Therefore in the temple of either of them or in the temple of Śrī Mahāvīra, the last Tīrthankara, one should contemplate in one's heart on Śrī Pundarīka, the first Gaṇadhara of Śrī R̥ṣabhadeva, or Śrī Gautamaswāmi, the first Gaṇadhara of Śrī Mahāvīra, seated in a golden thousand-petalled lotus. This also connects Śrī R̥ṣabhadeva with the Sūrimantra. It is further stated that the Sūrimantra as given by Śrī R̥ṣabhadeva to Śrī Pundarīka consisted of 300 verses, that the Sūrimantra given by Śrī Mahāvīraswāmi to Śrī Gautama consisted of 2100 letters and that Śrī Gautamaswāmi by the Lord's order abridged it to 32 verses (i. e. 1024 letters). With the lapse of time ultimately Duṣprasahasūri's Sūrimantra, it is foretold, will be reduced to a little more than 8 verses. At present according to one version it consists of 10 verses and 12 letters i. e. 332 letters. The Mantra being the same in the line of Gaṇadhara Śrī Sudharmāswāmi, by worship of Śrī Gautama it is said that all the preceptors are considered to have been worshipped. Then follow several Mantras of Śrī Gautamaswāmi. Thereafter the Ṣaṭkoṇa Yantra of Sūrimantra is described with all its Valayas.

There is a reference to Ṣaṭkarma and a statement that by observing the rules relating to directions, time, seats, Mudrās (manual gestures)* etc. the desired object can be achieved. Then contemplation on Omkāra in different manners is described. Thereafter contemplation on Hrīṃkāra and contemplation on Arhambīja, with the different results that are thereby achieved, are described. Then variations as to directions or seasons, times of the day, seats, Mudrās, rosaries and Mantra-Vinyāsas (Mantra-suffixes) and the different objects thereby achieved are described. The work also deals with Pūjārahasya i. e. mysteries relating to worship and describes the Nyāsa or the symbolical

* The rules as to directions etc. are generally similar to those described in the present work which have been already compared with the rules prevailing amongst the other Tāntrikas in the section hereof dealing with Tāntrika Sādhanā.

placing of various deities in the various Mantra-padas and various modes of Dhyāna.

In another Sūrimantrakalpa it is stated that Sūrimantra from Śrī Gautamaswāmi to Śrī Prabhavasūri was the same and the latter redacted it for Śṛtakevalis (Persons equalling the Omniscient through learning). Thereafter Vajraswāmi separated the Vardhamāna Vidyā from Gaṇi-Vidyā alias Sūrimantra. This fact is evidenced by several Kalpas. This gives us the various stages through which Sūrimantra has passed and shows its antiquity and sacredness.

PŪRVASEVĀ AND UTTARASEVĀ

We may note here and explain the two technical terms Pūrvasevā and Uttarasevā used amongst Jains in connection with Mantrasādhanā. According to one explanation the former means the ceremonies including Japa upto Homa and the latter means Homa and ceremonies incidental thereto (See Appendix 31, Adh. IV, vv.8-9) According to another explanation the ceremony prior to Siddhi or success is Pūrvasevā and the recital of the Mantra or Vidyā thereafter for a limited number of times daily or the rite required to be gone through for use or employment of the Vidyā or Mantra is Uttarasevā. See P. 346 Sādhanamālā Vol. II “ततः पूर्वसेवामक्षरलक्षजप्त्वा पश्चात् कर्म समारभेत् ॥”. We may also note that the Homa amongst the Jains is only with materials like dried fruits, rice and ghee, and appears to be in substitution of ‘Bali’ originally offered in Sādhanā of Vidyās—See Vasudevahindi P. 52. +

The writer considers that the preliminary worship as a result of which the Sādhaka obtains permission from the Mantra-deity to undertake the Sādhanā proper is Pūrvasevā and the Sādhanā proper including Homa is the Uttarasevā—See Yantra-Cintāmaṇi-Kalpa, pp. 7-8, II Pīthikā, vv. 27-30 where such method to obtain permission is recommended. The said portion being important is reproduced below :

+ ‘विज्ञाभो य पुरचरण-बलिविहाणेहिं सिज्जन्ति ।’

“यस्य कस्य प्रयोगस्य विधिरेष प्रकीर्तितः ।
 दिनत्रयं प्रकुर्वीत पूजाभोगविधानतः ॥२७॥
 त्रिरात्रं भूमिशायी स्याद् ब्रह्मचर्यरतः शुचिः ।
 त्रिदिनाज्जायते स्वप्नं साधकस्य वरानने ॥२८॥
 सिद्धं साध्यमरिं चैव सुसिद्धमथवा ध्रुवम् ।
 भवश्यं वदति स्वप्ने मन्त्राधिष्ठानदेवता ॥२९॥
 यदा न जायते स्वप्नं तदासाध्यं विनिर्दिशेत् ।
 नो चेद्यथाश्रुतं स्वप्ने तत्तथैव विनिर्दिशेत् ॥३०॥
 —श्रीयन्त्रचिन्तामणिकल्पे, द्वितीयपीठिका ॥

It is not stated above but is understood that during the three day's worship the Sādhaka should recite the Mantra at least 12500 times; in case of a mere Yantra, Pūjā alone for three days is deemed sufficient.

According to Lalitāsahasranāma–Bhāṣya (P. 5) Puraścaraṇa means preliminary worship after initiation (Mantra–Dīkṣā) and before ‘Upāsti’ i. e. actual worship. Actual Upāsti is therefore ‘Uttarasevā’. Viśeṣāvaśyaka–Bhāṣya V. 1199 and Haribhadrasūri's commentary on Āvaśyakasūtra (P. 74B) explaining the same are cited below as they give a similar explanation.

पाएण पुत्रसेवा परिमउई साहणमि गुरुतरिभा ।
 होति महाविज्जाए किरिया पायं सविघा य ॥
 —विशेष० भाष्य श्लो० ११९९

“The Pūrvasevā-preliminary worship is generally easy and the rites of Sāadhanā relating to Mahāvidyā are very difficult and are generally full of obstacles”.

“अनेकसंवत्सरानुपालिताचाम्लादि-पुरध्वरणक्रियासादित-गुणान्तरोत्तरसहायक्रियारहित-विद्यासाधक-वत् साधने (विद्यासाधने-मोक्षसाधने) क्रिया दुर्लभा प्रायः सविघ्ना (चित्तविघातादिप्रचुरविघ्नत्वात्) । Here also actual Sāadhanā is distinguished from Pūrvasevā and is thus identified with Uttarasevā. These authorities bear out the writer's view.

UNITY OF PANCA-PARAMEṢṬI-MANTRA, VARDHAMĀNA-VIDYĀ AND SŪRIMANTRA

According to Siṃhatilakasūri's Vardhamāna Vidyākalpa, page

54, Parmeṣṭividya together with some Stutipadas* and a portion extracted from Śrī Sūrimantra's Saubhāgyavidyā etc., i. e. from the 2nd Pīṭha, formed the Vidyā for Upādhyāyas. This must have been done probably in the time of Śrī Vajraswāmi and for reasons similar to those which prompted the separation of Śrī Vardhamāna Vidyā from Śrī Gaṇividya alias Sūrimantra. That they must have been one and undivided can be very well inferred from the following convention contained in the I part of Śrī Vardhamānavidyākālpa of Śrī Siṃhatilakasūri which contains the separate vidyās of all the twenty four Tīrthankaras.

“सर्वविद्यास्मृतावादौ पूर्णा पंचनमस्कृतिः ।

यद्वा पंचनमस्कृतिः यद्वा पंचपदी वाच्या ।

मुनिना प्रणवादिमा ॥

It means that at the time of recital of all Vidyās at the commencement should be said by the Sādhaka complete Panca Parameṣṭi Mantra or only the first five clauses comprising Panca Parameṣṭi Namaskṛiti proper or the five (initial) syllables (A-SI-Ā-U-SĀi.e. असिआउसा) with Omkāra at the very beginning.

This shows that Panca-Parmeṣṭi-vidyā, Vardhamāna-Vidyā and Gaṇividya were formerly one and undivided. When, therefore, Sūrimantra is shown to have been connected with the first Lord, one can conclude that Pancaprameṣṭividya also must have been so connected. It stands to reason that in the time of a particular Tīrthankara his Vidyā must have been incorporated in the Sūrimantra and must have been finally substituted by that of the last Tīrthankara.

SIDDHACAKRA

We shall now deal with the worship of Śrī Siddhacakra^x which is the representation in a circular Yantra or diagram of Pancapara-

* उणमो ओहिजिणाणं, उणमो परमोहिजिणाणं, उणमोसब्बोहिजिणाणं, उणमोअणंतोहिजिणाणं । are the four Stutipadas which usually follow the five Padas of Panca-Parameṣṭi-Mantra. All the nine padas are also known as Nāndīpadas.

^x It is wrongly rendered as 'Saint-wheel' by European scholars.

meṣṭi and the four essentials+ for salvation (together forming Navapada i.e. nine padas) as it is very old and has been mentioned in Nirvāṇa kalikā and is connected with the Panca-Parmeṣṭi Mantra. We mention this because worship of Śrī Siddhacakra alias Navapadapūja is even now very popular and is attended to by hundreds of worshippers both male and female and performed with great devotion and eclat.

This Siddhacakra worship must have become specially popular since the bifurcation of the ancient Gaṇivijjā into Sūrimantra and Panca-parameṣṭi Vidyā. This is supported by the inclusion of all the 'Labdhi-padas' which form the first Pīṭha of Sūrimantra in Śrī Siddhacakra Bṛhadyantra. The worship of Sūrimantra is so to say a privelege of the Āchāryas; the ordinary Sādhus must be satisfied with the worship of Vardhamāna Vidyā, formerly a part of Sūrimantra, and the relative Yantra. The worship of Panca-Parmeṣṭi is performed by the laity in the form of Navapadapūjā. Different kinds of austerities have to be performed in all the three kinds of worship. Many elements of Tāntrika worship of the purer kind× can be seen in Navapadapūja. Large congregations of people jointly offer worship and there is chanting of hymns to the accompaniment of music. There is recitation of Mantras by each worshipper for the number of times prescribed. The period of worship extends over nine days; and on each of the nine days, one of the nine padas, which include Panca Parmeṣṭi, is principally worshipped, beginning from the 7th day of the bright half and ending on the 15th thereof in the months of Āśvina and Caitra. During this period the worshippers take only one meal a day consisting of simple spiceless food, devoid of milk, ghee, oil, sugar and vegetables. Śrī Siddhacakrayantra is worshipped daily and a five-coloured Nava-pada-Mandala is also drawn in the centre of the place of worship.

+ They are faith, Knowledge, good conduct and austerity i.e. दर्शन, ज्ञान, चरित्र and तप।

× Contemplation on the five 'Tattvas' is a requisite for the Divya' or divine class of Tāntrika worshippers. The five colours given to Panca-Parameṣṭi in Navapada-Pūjā are said to be meant for such Dhyāna.

The worshippers read or hear from Sādhus the biography of Śrīpāla from Śrīpālarāsa a work composed by Upādhyāya Śrī Vinayavijaya and the famous Jain logician Upādhyāya Śrī Yaśovijaya about s. y. 1738. The Siddhacakra worship is completed when it is performed nine times i. e. for nine periods of nine days. It thus takes four and a half years to complete. When completed each worshipper celebrates it by offering special worship and distributing gifts amongst the worshippers. One of the places believed to have been visited by the legendary King Śrīpāla, who is described as an ideal worshipper of Śrī Siddhacakra, in course of his voyage, is believed to be the town "Sopāraka", not far from Thānā.* In fact at Thānā, a temple of Śrī Navapada alias Śrī Siddhacakra is being constructed to commemorate this visit as a result of the preachings of Śrī Jinaṛddhisūri and his learned pupil Śrī Gulābamuni. A large Siddhacakrayantra is represented there in the form of a large many-petalled lotus carved in stone.

WORSHIP OF MANTRA-DEITY NOT INCOMPATIBLE WITH KARMA-PHILOSOPHY

We may here refer the readers, desirous of knowing the Jain view as to how Mantra acts, to the writer's view set forth at p. 35 et seq.; and also draw their attention as to how Mantravāda which is essentially Ādhidaivikavāda merges ultimately into Ādhyātmikavāda. One may question as to how the Jains who are staunch believers in the philosophy of Karma reconcile with it Mantravāda or Ādhidaivikavāda. How can a Mantra-deity make anyone happy or otherwise? We do not desire to tax our reader's patience with any philosophical discussion about the matter. To explain we would only cite what Yaśodevasūri, pupil of Śrī Candrasūri, says in his commentary (written in S. Y. 1180) on Pakkhīsūtra (P. 72) as to why Śṛtadevatā or Sarasvatī should be worshipped. The worship of 16 Vidyādevīs 64 Indras, atten-

* Thānā also appears to be an old town. It is mentioned in the commentary of Śrī Malayagiri (who flourished circa 1160 to 1220 of the Vikrama era) on Śrī Vyavahārasūtra, I Uddeśāka P. 127.

dant deities of Tirthankaras like 24 Śāsanadevīs and 24 Śāsanayakṣas,* 9 Planetary deities (Nava Grahas), 10 Wardens of Directions (Daśa Dikpālas) and Warden of land (Kṣetrapāla) and various Mantra-deities presiding over various Mantras, Miraculous works, Sūtras§ and Stotras, deities presiding over Gacchas, Gotras, Kulas, villages, towns, forests etc. is to be similarly reconciled. Here is the explanation by Śrī Yaśodevaśūri. He cites the following verse from Kalpa Bhāṣya, which says “All that is endowed with good characteristics or excellence is presided over by a deity and Sūtra having been propounded by the omniscient is so endowed”;⁺ and says that Śṛtadevatā i. e. the deity presiding over the sacred literature therefore does exist. If it is urged that devotion to the sacred literature personified as a deity may be justified as such devotion is known to destroy the veil of one’s Karmas but not that of Śṛta-devatā, a deity merely of the Vyantara or similar class as she cannot be supposed to have power to destroy other’s Karmas. The answer is “As the Dhyāna of Śṛtadevatā is said to destroy the Karmas (of the worshipper), to say that Śṛtadevatā does not exist or is incapable of doing anything is irreverence in reference to her.”

* In Senapraśna by Śrī Vijayasenasūri, in answer to the question No. 16, it is said that worship of Ekākṣa Nālikera (a kind of cocoanut) like that of conch curved to the right for worldly benefit and prosperity is not considered want of faith i. e. a transgression of Samyakdarśana.

§ The Jains like others believe some gāthās or verses of their Scriptures to be endowed with miraculous qualities. The first that may be mentioned is the benedictory verse of Candrapannatti sūtra, and the next the benedictory verse of Daśavaikālika-sūtra. Uttarādhyayana has also a gāthā considered to be so endowed. It is:

“चइत्ता भारहंवासं चक्रवट्टी महिषिओ ।

संती संतिकरो लोए पत्तो गइमणुत्तरं ॥१८ अध्ययन, श्लोक ३८

The hymns for daily recital also are supposed to have miraculous qualities and particular verses of some of them are considered to be especially miraculous. There are Mantra-Kalpas also in respect of some of these hymns.

+ सम्बं च लक्खणोवेयं समद्विट्ठन्ति देवता ।

सुत्तं च लक्खणोवेयं जेण सम्बणुमासियं ॥

सुयदेवयाए जीए संभरणं कम्मखयकरं भणियं ।
नत्थित्ति अकज्जकरी व एवमासायणा तीए ॥

Readers interested in a detailed discussion are referred to *Sāmācārī Sataka* by Upadhyāya Srī Samayasundara P. 186 et seq. There a further objection against worship of deities, who have not attained salvation, is raised that they are at a lower stage of spiritual progress (*Guṇasthānaka*) viz. the fourth while even a layman who has taken vows meant for the laity is on the fifth and *Sādhus* on still higher stages and that it is not proper that a person more advanced spiritually should worship one who is at a lower spiritual stage. The author while meeting this objection cites a verse to the effect that even a layman knowing only *Pancaparamēṣṭi-Mantra* (and therefore not gone beyond the fourth stage of spiritual progress) should be looked upon with such regard as is shown to the best of friends.* This is on the principle that even the slightest merit does deserve praise and praise of one possessing the right faith destroys the veil of *Karmas*. It is therefore natural that the deities possessing the right faith though only on the fourth stage of spiritual progress being endowed with great miraculous powers and supersensual knowledge may be worshipped for obtaining the right faith, higher knowledge or miraculous powers or worldly happiness. By obtaining the right faith and higher knowledge one advances on the path leading to salvation and thus worship of *Mantra-deities* also can contribute towards spiritual uplift and ultimate salvation of the worshipper.† But those who care for final beatitude only will naturally prefer to worship as their ideal deity only one who is *Siddha* and *Mukta*. They are pure *Ādhyātmavādis*. Some intermediary deities however are much pleased with such a truly

* “तम्हा सब्बपयस्सेणं जो नमुक्कारधारभो ।

सावभो सोऽवि दिट्ठव्वो जहा परमबंधवो ॥”

† “जा दिट्ठीदाणमित्तेण देह पणयाण नरसुरसमिद्धि ।

सिबपुररज्जं भाणारयाण देवीइ तीइ नमो ॥ आराधनापताका ॥

spiritual worshipper and voluntarily aid him in whatever he does though he never desires their aid. It is thus that Mantravāda which is principally connected with Ādhidaivikavāda leads to Ādhyātmavāda and is practised even by persons striving only for final beatitude. Om, Hrīm, and Arham are the Mantra Bījas usually recited by such Ādhyātmikas.

We may here mention that of the various Tāntrika Sampradāyas already mentioned the Jains may be said to follow Kashmere Sampradāya, for the reasons that Jain worship is essentially Sāttvika and that Jains are known from the most ancient times to worship Sarasvatī or Śṛtadevatā, the goddess of learning, and the principal quality of Tīrthankara is omniscience universal knowledge,* and Sarasvatī is known to be a Sāuvika deity, principally worshipped in Kashmere Sampradāya, and Kashmere is known to be her abode.+ It is true that sometimes she is worshipped there under the name of Tripurā, but it is only another name of Sarasvatī. It is said by a Tāntrika writer that of the 51 or 52 Pīṭhas § in various parts of India, the Pīṭha at Kashmere is of Kṣīra-Bhavānī* who can be easily identified with Sarasvatī who is known to be of milk-like whiteness. According to Bhagavatī Bhāgavata the Pīṭha there is of Medhā or intellect. According to a legend the famous scholar Hemacandrācārya also proceeded towards Kashmere for the Sādhanā of Sarasvatī but she was pleased to grant him the desired boon on the way and he returned to Cambay having achieved his object. Similarly as Jain Ācāra is Sāttvika it can be

* See Nirvāṇakalikā P. 34 where Shakti of Arhan is said to be Jnānashakti i. e. Sarasvatī.

+ 'नमस्ते शारदे देवि काश्मीरपुरवासिनि ।'-सरस्वतीरहस्योपनिषत् ।

§ The Pīṭhas are considered to be 72 or 108 according to other authorities.

The Pīṭha is situate near Gandharval which is fifteen miles to the north of Śrīnagar, the capital of Kashmere. The temple of Kṣīrabhavānī is in the midst of a Kunda or tank. The deity is variously known as Yogamāyā or Mahāmāyā. A fair is held in her honour on Jyeṣṭha Śuklā Aṣṭamī each year. See p. 639 Shakti-issue Vol. IX Kalyāṇa, 1934.

compared to Samayācāra which has been propounded by Śrī Sankarācārya in his famous hymn 'Saundaryalaharī'. His other works propounding Sāmayikamata are Ānandalaharī, Prapancasāra, Lalitātriśatī—Bhāṣya as has been stated by the learned author of 'Śākta Sampradāya' in Gujarati (See P. 33 and P. 100). It must be noted however that Panchatattva worship is not countenanced in Jainācāra in any form whatsoever. At P. 69 Śākta Sampradāya it is said "only in Jainācāra these things i. e. Panchatattvas have no place."

HĀDI MATA

Strictly speaking there are no distinctions made amongst Jains in respect of Matas based on the worship of different deities or on different Mantras as they begin with the letters 'Ka' or 'Ha' etc. As however in what is termed the Jaina Bīja 'Arham' the principal letter is 'Ha' and because 'Hrīm' is considered an equally important Bīja amongst Jains indicating 24 Tīrthankaras with their male and female attendant deities and is the central Bīja in Ṛṣimandala Yantra and because 'Hrīm' is also the 'Ekākṣarī Mantra' of Śrī Padmāvati identified with Tripurā the deity principally worshipped in Hādi Mata (See P. 53 ante) and Kashmere Sampradāya and because in Sūrimantra, the principal Mantra amongst the Jains, the Bījas adopted along with 'Om' and 'Hrīm' and 'Arham' and not any Bīja beginning with the letter 'Ka' the Jains may be generally speaking said to follow Hādi Mata without thereby suggesting acceptance thereof with all its implications.

EARLIER MANTRASIDDHAS

The name of Śrī Gautamaswāmi stands at the forefront of Mantrasiddhas as he was the first Gaṇadhara of Śrī Mahāvīra and composed Sūrimantra under his direction. He was possessed of all kinds of miraculous powers (Labdhis). Exercising one of them he flew up the Aṣṭāpada Mountain unapproachable by ordinary beings, and made

* See Nirvāṇakalikā P. 7 for principal rules of Jainācāra. Digambara Jains also hold identical views on Mantra and Ācāra, see the article by Pt. K. Bhujabali Śāstri entitled Jain 'Mantra-śāstra', Jain Siddhānta Bhāskara Vol. IV, 3, P. 135 ff.

obeisance to the Śaśvata Caityas or permanent images of the Tīrthankaras there; and exercising another he fed 1500 ascetics from his single bowl full of Kṣīra (milk and rice preparation). Invocation of his name in the morning is believed even today to keep the devotee well fed, clad, provided for and free from want of every kind. The readers will learn in the next section that according to a set description all Gaṇadhara are said to be Mantrapradhāna and Vidyāpradhāna or prominent in Mantras and Vidyās and that not only Gautamaswāmi but Sudharmāswāmi and Keśikumāra Śramana a spiritual descendant (of Śrī Pārsvanātha) also are expressly so described. Similarly many of the 'Therās' or old Sādhus are so described at p. 32 of Śrī Aupapātika Sūtra.

We have already mentioned how the sixth pontiff Śrī Bhadrabāhu composed the Māntrika hymn 'Uvasaggaharam'. *

The Āchāryas who may be noted next are the ninth pontiffs, Śrī Susthitasūri and Śrī Supratibuddhasūri (291 to 372 of Vīra era). They gave to the Nirgrantha gaccha the name of the Koṭika Gaccha, as they recited Sūrimantra a crore (Koti) times. Next Āchārya in the main line was Indradinnasūri who died about 421 Vīra era. Priyagranthisūri was his co-pupil. In Pattāvali and commentaries on Śrī Kalpasūtra an anecdote is related about him that he recited Mantra on Vāsa (scented powder)

* Muni Śrī Puṇyavijayaji in his recent article in the Silver Jubilee issue of Śrī Mahāvīra Jaina Vidyālaya considers the hymn to be by a later Bhadrabāhu, of the Sixth century of the Vikrama era, probably a brother of the astrologer Varāhamihira. He has however not shown therein that the knowledge of Mantra or Nimitta was in any way inconsistent with the knowledge of 14 Pūrvas of the Śrutakevali Bhadrabāhu, the sixth pontiff. We have shown above that Nimitta was a part of the ninth Pūrva and Vidyās and Mantras of the tenth Pūrva. Niśītha is admitted to be by the 1st Bhadrabāhu and was extracted by him from the ninth Pūrva which also comprised Nimitta. Niśīcha itself refers in its 13th Uddeśa to Vidyās Mantra and Nimitta. Sthūlabhadra, the pupil of the 1st Bhadrabāhu, while studying the tenth Pūrva employed a Vidyā and assumed the form of a lion and was taken to task by his preceptor for such wanton employment of Vidyā. This shows that the 1st Bhadrabāhu knew Nimitta, Mantras and Vidyās and there is nothing against his having composed the hymn 'Uvasaggaharam.'

and caused it to be dropped on the goat tied to the sacrificial post for being sacrificed and it flew up in the sky and, inspired by Śrī Ambikā, extolled in human speech the doctrine of Ahimsā and directed the Brahmanas there to approach Śrī Priyagranthisūri for learning the true Dharma. They thereupon approached Priyagranthisūri and thereafter strictly observed the doctrine of Ahimsā.

Chronologically we should mention here Ārya Rohaṇa, Kālakācārya, Revatimitra Vidyācakravarti Ārya Khapuṭācārya, and Upādhyāya Mahendra, then Śrīguptācārya, Vajraswāmi, Pādaliptasūri, Nāgārjuna and others but as details from their lives are given further on we need not say anything about them here. We would only mention Ārya Nandila (circa 600 Vira era) here. He composed the famous Māntrika hymn to Śrī Vairoṭyā one of the queens of Dharaṇendra. This hymn is preserved and printed. The details about the life of Ārya Nandila the readers can learn from Prabhāvakaacaritra.

VIDYĀDHARAS

We have described in details in the next section the origin of Vidyādharas through the two brothers Nami and Vinami, in the times of Śrī Ṛṣabhadeva, the first Tīrthankara, who were gifted with 48000 Vidyās of Gandharvas and Pannagas by Dharaṇendra the Indra of the serpent-deities (See p. 161-162 Āvaśyakacūrṇi) and who used to worship Śrī Ṛṣabhadeva as also the presiding deities of the several Vidyās.* As these are more or less legendary persons we describe below

* That daily worship of Vidyādevīs was current in the ancient times amongst Jains is evidenced by such mention thereof in Vasudeva-Hiṇḍi (P. 366) as the following:

“रोहिणी विज्जादेवयं सदा अच्चेमि ॥”

i. e. “I always worship Vidyādevī Rohiṇī.” The importance of this reference would be immediately recognised when it is remembered that it occurs in a work written by Śrī Sanghadāsagaṇī who holds an unique position amongst Jains as a Bhāśyakāra of Siddhānta. The above is not a solitary instance. On a careful perusal of the said work, several instances of worship of Vidyādevīs and other deities for accomplishment in Vidyās would be found. See p. 318 *ibid* for worship of the idol of Dharaṇendra. A reference to worship of the idol of Hariṇegameśī is found in Antagaḍadasāṅga, III, 8, Sutra 6: “ततेणं सा सुलसा बालप्पभित्तिं चैव हरिणेगमेसीभत्तया याविहोत्था हरिणेगमेसिस्स पडिमं करेति ।”

Vidyādhara who were contemporaneous with Śrī Mahāvīra.

VIDYĀDHARA PEDHĀLAKA AND VIDYĀCAKRAVARTI MAHEŚVARA

At pp. 685 ff. of Śrī Haribhadrasūris' commentary on Āvaśyaka-sūtra are described the doings of Vidyāsiddha Pedhālaka who was a non-Jain ascetic contemporaneous with Śrī Mahāvīra and his son Satyaki who accomplished the Sādhanā of Mahārohiṇī killed Pedhālaka and became known as Rudra and overpowered Kālasaṃdīpaka who created three Puras or bodies in the fight. He thus became Vidyācakravarti and was given the name 'Maheśvara'. He had two pupils Nandīśvara and Nandī who were also similarly accomplished. The important feature of this anecdote is the belief amongst Jains in the extraordinary powers acquired by Sādhanā of Vidyās such as Mahārohiṇī and others even in such early times. We need not add that Rohiṇī is the first in the group of sixteen Vidyādevīs⁺ in the Jain Pantheon.

In the next section we shall show by references from Sūyaga-daṅgasūtra, Paumacariyam and Vasudeva-Hiṇḍi that Vidyās used to be employed by Vidyādhara from the most ancient times, and how Śrī Pārśvanātha's worship became extremely popular.

ŚRĪ RATNAPRABHASŪRI

In the line of Śrī Pārśvanātha in 52 Vīra era flourished Āchārya Śrī Ratnaprabhasūri. He was a pupil of Svayambhavasūri and a grand-pupil of Śrī Keśikumāra Śramana. It is related about him that he was a Vidyādhara accomplished in Vidyās especially Akaśagāmini or the flying lore and Bahurūpiṇi or the lore enabling one to assume as many bodies as one liked and bore before his initiation the name Ratnacūda. He revived the son of a minister bit by a serpent and given up as dead by his magical power and converted lacs of people headed by the said minister to Jainism and formed them into the Ośwāla caste which exists to

⁺ "Of all the conceptions found in the Jains Iconography, none is so original as the conception of the Vidyādevīs or the Goddesses of learning". Page. 163, The Jain Iconography by Prof. B. C. Bhattacharya

this day amongst Jains. He was such a powerful and accomplished preacher that he made even the deity Cāmundā accept the doctrine of Ahimsā who was thence known as Satyikā or Saccikā. He founded the Upakeśa Gaccha and Saccikā became the patron-deity thereof as also the Gotradevī of Ośwāla families. He installed simultaneously in the two cities of Upakeśa and Koraṅṭaka the idols of Śrī Mahāvīra by projecting his double at Koraṅṭaka. For details about him and other Āchāryas of Upakeśa Gaccha gifted with miraculous powers the readers are referred to Upakeśa Gaccha Pattāvali in Sanskr̥t published in Jain Sāhitya Saṃśodhaka Vol. II, 1.

VIDYĀDHARA-KULA ETC.

It is worth noting that there is a Vidyādhara kula, Gaccha, Vaṃśa or Śākhā known amongst the Jain Sādhus. Vidyādhara Gopāla, one of the several pupils of Susthitasūri and Supratibuddhasūri, on the one hand and Vidyādhara, the pupil of Vajrasena and grand-pupil of Vajraswāmi on the other, are credited with starting the same. The writer thinks that Vidyādhari Śākhā, Gaccha or Vaṃśa was started by Vidyādhara Gopāla and Vidyādhara kula by Vidyādhara the grand pupil of Vajraswāmi. It is but natural that one of the pupils of Āchāryas, who were credited with doing one crore Japa of Sūrimantra, should be a Vidyādhara i. e. one accomplished in Vidyās and start a Śākhā or Gaccha-Vaṃśa known after his name. This really indicates that from Susthita and Supratibuddha Āchāryas commenced great activities to acquire proficiency in Mantras and Vidyās. These activities ultimately produced such grand personalities as Kālakācārya, Vajraswāmi, Vidyā-Cakravarti Ārya Khapuṭācārya, Upādhyāya Mahendra, Pādaliptasūri, Ārya Nāgārjuna and others.

CAITYAVĀSIS

Although Caityavāsi Sādhus had great authority and influence over Svetāmbara Jains for about a thousand years, their connected history is not available nor is it possible satisfactorily to reconstruct it. We have to rely generally upon probabilities and can draw only

tentative conclusions. We have some information about some Āchāryas who were Caityavāsis or disciples of Caityavāsi preceptors or in whose life we find Caityavāsi practices. The causes and the circumstances which contributed to the rise of the Caityavāsis seem to be practically buried in the past except for our suggestion in the foregoing portion hereof that practices similar to those prevalent amongst them did exist in the past as noted in Āvaśyaka Niryukti and might have contributed to their ultimate rise. We can therefore place only such facts before the readers as can be gathered on the subject together with our suggestions as to what might have probably occurred which would satisfactorily explain the situation as it might be imagined to have gradually developed. We do it in the hope that it may give an impetus to the antiquarians working in the same field to discover further materials with which a more satisfactory Jain history can be reconstructed.

Although nowadays 'Caitya' means a temple or an idol originally it meant also a memorial constructed on the place of cremation of a dead body or the abode or temple of a Vyantara deity or Yakṣa or a sacred tree around which some sort of platform was constructed. Some time in the beginning of the Vikrama era it came to be commonly understood as a temple. 'Caityavāsis' meant those Jain ascetics who took up their residence in Jain temples. The Jain Sāstras however never permitted such residence which was more or less of a permanent character and brought in its train the management and ultimately the ownership of the temples where the particular Sādhus resided. Consequently much laxity in the observance of the rules of conduct for Sādhus prevailed amongst them. The liberties taken originally were slight e. g. acceptance of honorific paraphernalia of a king such as horse, elephant, palanquin, umbrella and chowries, as an Āchārya was considered not only the head of the Sādhus but the spiritual head of the people in no way lesser than the temporal head, a king. In fact, according to Nirvāṇakalikā, when Āchāryaship was conferred upon a Sādhu, it was the practice inter alia to present to him the

royal paraphernalia above described. (See page 9-B Nirvāṇakalikā). The author of Nirvāṇakalikā is Pādaliptasūri above referred to who flourished about the first century of the Christian era. * Now about the time this practice of presentation of royal paraphernalia to an Āchārya arose, he must have had also some place to keep them. It can be well imagined that they must have been kept somewhere near a place which he might have taken up as his residence for the greater part of the year; that such a place was usually connected with a Jain temple appears to be proved by the accounts we are able to gather of the Caityavāsīs. We would therefore be justified in inferring that about the time of Śrī Pādaliptasūri Caityavāsa must have been considerably old to allow an Āchārya to accept, and maintain even royal Paraphernalia.

ĀRYA MAHĀGIRI AND ĀRYA SUHASTI

On a careful study of the ancient Jain literature we find that the question of residence of the Jain Sādhus assumed prominence which it had not done before, first about the time of Ārya Mahāgiri and Ārya Suhasti the two joint pontiffs who succeeded Sthūlabhadra in or about 215 Vīra era. The former is generally supposed to have died about 245 and the latter about 291 Vīra era.

Ārya Mahāgiri resolved to follow, as far as possible, Jinakalpa or the strict course of conduct which had been followed by most of

* Śrī Kalyāṇavijayaji in his introduction to the Gujarāṭi translation of Śrī Prabhāvakacaritra has tried to show the date of Pādaliptasūri, the author of Nirvāṇakalikā, to be from about the end of the 2nd century to the first half of the 3rd century of the Vikrama era, on the supposition that the word 'Murunḍa' which means 'master' could have been applied to the ruler at Pātliputra only after it came under the sway of the Kuśāna rulers, and that it came under their sway between s. y. 177 and 219, and from the date of Ārya Nāgahasti given in 'Yugapradhāna-Pattāvali viz. s.y. 151 to 219. He has however not explained the mention of Tarangavaikkāra, (author of Tarangavatī novel) i. e. Pādaliptasūri, by Āryarakṣitasūri in his work Anuyogadwāra. Āryarakṣitasūri, who is supposed to have died in s. y. 127 (s. y. 114 according to Śrī Kalyāṇavijaya himself), could not have mentioned Pādaliptasūri supposed to be born later. The writer therefore considers the 1st century as the correct date of Śrī Pādaliptasūri.

the Sādhus who were Śrī Mahāvira's contemporaries. It had however gone out of vogue after him owing to the hardships it entailed. Ārya Mahāgiri as a rule remained away from cities and villages. Even when he did visit them it was only for a very limited time except that during monsoon he would stay at any one place throughout. He performed severe austerities and underwent hardships incidental to the practice of Jinakalpa.

Ārya Suhasti on the other hand, having regard to the lack of requisite stamina in the Sādhus of his time, preferred taking up residence in towns and villages, which was again of much longer duration than that allowed to the followers of Jinakalpa. It also appears that Ārya Suhasti did not prevent his pupils from accepting food offered to them by persons in charge of the Royal alms-houses out of what came to their share. These keepers of the alms-houses did so as they were promised and paid price thereof by the King. Ārya Mahāgiri suspecting this remonstrated with Ārya Suhasti, and when the latter did not admit his connivance, Ārya Mahāgiri threatened not to take food jointly with Ārya Suhasti and his pupils. Ārya Suhasti thereupon apologised to him and Ārya Mahāgiri accepted the apology but remarked that it was a fault occasioned by the decadent times and left the place. Thus arose the separation in food or "Asambhogikatā." among different groups of Sādhus.

JAIN EMPEROR SAMPRATI

It is a generally accepted historical fact that Emperor Aśoka had a son Kuṇāla (called Suyaśas by some Purāṇas) whose son was Samprati (or Sampadi according to the Buddhists). Samprati governed Ujjain alias Avanti for a considerable time as a Viceroy during the reign of Aśoka. According to the Buddhist sources Sampadī was the heir apparent during the life time of Emperor Aśoka and during the last illness of Aśoka prevented the latter from entirely squandering away the Royal treasury by making very huge gifts of crores of gold coins to the Buddhist monastery Kurkuṭārāma. He was crowned King.

on the death of Aśoka. (See Divyāvadāna, * XXIX Avadāna, pp. 430–433. See also Bodhisattvāvadāna Kalpalatā, Pallava 74, vv. 8–12 p. 597).

Matsyapurāṇa (Adh. 272) which is considered the most reliable among Purāṇas, mentions Saptati i. e. Samprati as the grand-son of Aśoka and that he ruled for 10 years, and that Daśaratha, his son (i. e. Aśoka's son) for eight years. The only other Purāṇa which mentions Daśaratha is Viṣṇupurāṇa. It mentions 'Samyuta' (i. e. Samprati) as his successor. Bhāgavata, Vāyu and Brahmāṇḍapurāṇa do not mention Daśaratha at all. Bhāgavata mentions Sangata and Brahmāṇḍapurāṇa mentions Bandhupālita instead as successor to Suyāśas alias Kuśāla or Kunāla. It would appear from this confusion that Purāṇas generally had no reliable tradition or exact information about Maurya Kings subsequent to Aśoka. According to the Jain tradition * Samprati was a great emperor and his kingdom extended in the north beyond Takṣaśilā and in the south included Andhra and Dramila or Dravidian territory. This Samprati saw Ārya Suhasti † when the latter was going in a religious procession (Rathayātrā) at Ujjain or Vidiśā (modern Besnagar or Bhilsā a town about 120 miles to the East of Ujjain). He thereupon interviewed him. Being impressed by the deep and wonderful knowledge and religious discourse of Ārya Suhasti, Samprati embraced Jainism. His life since that time shows his great zeal for

* According to Rhys David Divyāvadāna appears to have been written about 3rd century A.D.

× The earlier references to King Samprati are as follows: Bṛhatkalpabhāṣya (circa 6th century A.D.), Uddeśa I., vv. 3275–3289, Vol. III, pp. 917–921; Bṛhatkalpacūṛṇi p. 22; Viśeṣāvaśyakabhāṣya (circa 645 A.D.), V. 861 and commentaries thereon. See Niśīthabhāṣya and Niśīthacūṛṇi, V Uddeśa, (circa 6th and 7th centuries respectively), p. 191 (Ms.), and p. 437 s.y. 1995 edn.

संपति रणुप्पत्ती सिरिघर उज्जाणि हेटे बोधव्वा ।

अज्जमहागिरि हत्थिप्पभित्ती जाणइ विससंगो (विसंभोगो) ॥ २५९४, भा०गा० २१४२

+ अज्जसुहत्थाऽऽगमणं, दट्टं सरणं च पुच्छणा कहणा ।

पाथयणम्मि य भत्ती, तो जाता संपति रणुप्पो ॥ ६० भा०, गा० ३२७७

Jainism. He is credited with building numerous Jain temples throughout his kingdom and installing idols of Jina. Magnificent processions with the idol of Jina carried in a chariot used to be taken out not only by Samprati but also by kings under his suzerainty. Special worship used to be performed in Jain temples on such occasions. ‡ By his influence he spread Jainism throughout his kingdom § and made through missionary activities even border countries fit for the visit and stay of Jain Sādhus. The missionaries went there dressed like Jain Sādhus and instructed the people there into the practices of Jain Sādhus and the rules regulating their mode of obtaining food and other necessities*

‡ अणुजाणे अणुजाती, पुष्कारुहणाइ उक्किरणगाइं ।

पूयं च चेइयाणं, ते वि सरज्जेसु कारिंति ॥ बृ०भा०, गा० ३२८५

§ जति मं जाणह सामिं, समणाणं पणमहा सुविहियाणं ।

दग्गेण मे न कज्जं, एयं खु पियं कुणह मज्जं ॥ बृ०भा०, गा० ३२८६

* Some important later Jain references to Samprati are:

1. Yaśodevasūri's commentary on Devaguptācārya's Navatattva-Prakaraṇa (1174 Vikrama era) describes the life and doings of Samprati (pp. 4 to 12).
2. Maladhāri Śrī Hemacandrasūri's Puṣpamālā-Prakaraṇa with his own commentary (12th century Vikrama era) v. 244, P. 426.
3. Śrī Hemacandrācārya's Pariśiṣṭha Parvan (13th century Vikrama era).
4. Dharmaghoṣasūri's Rṣimanḍala Prakaraṇa v. 184 (1328 Vikrama era); commentary on ditto by Śrī Padmamandiragaṇi.
5. Śatrunjaya Kalpa by Śrī Dharmaghoṣasūri (14th century Vikrama era).
6. Śatrunjaya Kalpa by Śrī Jinaprabhasūri v. 35 (14th century Vikrama era).
7. Kakkasūri's Nābhinandana Jinoddhāra-Prabandha (1393 Vikrama era) III, v. 100.
8. Śrī Jayaśekharasūri's Prabodha Cintāmaṇi (1462 Vikrama era), Adh. VI vv. 77 to 80.
9. Śrī Ratnamandiragaṇi's Upadeśatarangiṇi (Circa 1517 Vikrama era) pp. 104-107.
10. Śrī Jinasundarasūri's Dīpālikā-Kalpa (1483 Vikrama era).
11. Śrī Śubhaśīlagaṇi's Śrī Bharateśvara Bāhubalivṛtti (1509 Vikrama era) pp. 168 to 173.
12. Kalpadīpikā p. 144 A (1677 Vikrama era).

European historians like Vincent Smith think that Maurya Kingdom was perhaps divided on the death of Aśoka between Daśartha and Samprati, the former taking the eastern and the latter the western provinces; + but the fact that Purāṇas mention the name of Samprati amongst rulers of Magadha contradicts such a conclusion. Further, Buddhist works like Divyāvadāna state that Samprati succeeded to the throne of Aśoka and was crowned as king on the death of Aśoka. Even the inscriptions of Nāgarjuna hills recording gift of three caves by Daśaratha to Ājīvikas do not say that Daśaratha was the successor of Aśoka nor do they bear any date. Further the inscriptions do not describe Daśaratha as a Maurya. He is there styled 'the beloved of the gods' (देवानां प्रिय). This is the only phrase which may lead one to consider that Daśaratha might possibly be a Maurya. If we take the Buddhist and Jain evidence together it definitely proves that Samprati was the successor of Aśoka. We have considered it necessary to go rather in details into this question as the meeting of Samprati with Ārya Suhasti and his efforts for the spread of Jainism as detailed above form the central plank in the history of the Caityavāsis. Although the Caityavāsis as a body came to be organized much later, Caityavāsa and various lax practices found with it had already taken roots about this time* and gradually grew and gathered strength by about the 2nd century of the Vikrama era.

13. Kalpasūtra's commentaries : Kiraṇāvali (1628 Vikrama era) p. 165, Kalpalatā (1685 Vikrama era) p.224, and Subodhikā (1696 Vikrama era) p. 163 B—all being of the 17th century Vikrama era.

14. Upādhyāya Śri Samayasundara's Ghanghāni or Dhandhāni Tīrtha Stotra which records finds of idols of Samprati on Jetha Sud 11th 1662 Vikrama era, P. 178 Śri Jain Śvetāmbara Conference Herald Vol. XIV, Nos. 4 to 6

15. Vijayalakṣmīśūri's Upadeśaprāsāda (19th century Vikrama era).

+ Even Vincent Smith admits that "there is no clear evidence to support this hypothesis." P. 181 Early History of India.

* Arya Mangu a contemporary of Śri Kālakācārya being fond of rich food remained at Mathurā continuously for a long period till he died there and became Yakṣa. He is cited as an instance of lax practice although he was otherwise a great Āchārya.

PERIOD AFTER SAMPRATI

The innumerable temples constructed and the far more innumerable idols installed in the most distant parts of Samprati's kingdom might have found from amongst those who were freshly converted to Jainism necessary worshippers and care-takers not only during his reign but also for some time thereafter. Ultimately however the duty must have devolved upon those who were hereditarily Jains, and where they were very few or non-existent the Jain Sādhus must have been compelled to take upon themselves the care of the temples. Many of these temples were built in far distant parts of Samprati's kingdom, to travel where, the Jain Sādhus must have experienced great hardships. Gradually, those Sādhus who were not very self-sacrificing constantly to undertake travels in strict accordance with the letter of the rules of conduct for them must have remained near about such temples for longer periods and must have ultimately taken up their residence in temples themselves. This must have of course taken finally to crystallize about a couple of centuries. There must have been also forces of ideal Sādhus trying to check and counteract this downward tendency. In fact we find such efforts in the biography of Śrī Vajraswāmi. How the times aided this downward tendency can be seen from the occurrence of several famines including three long famines * since Nirvāṇa of Śrī Mahāvīra each extending over a period of twelve years, which devastated the land and annihilated men and animals and put an end to all culture. The wonder is that good conduct, learning and culture at all survived these recurring long famines. All the same they took their toll; and we find the best of Sādhus fasting unto death with Śrī Vajraswāmi.

Before we deal with the life of Śrī Vajraswāmi we would briefly describe the times after Samprati as evidenced, by history. Within 50

* The first occurred a little prior to the death of Śrī Bhadrabāhu i.e. 170 years after Śrī Mahāvīra's Nirvāṇa and the second a little prior to the death of Śrī Vajraswāmi 584 Vīra era and the third was about 980 Vīra era.

years from the death of Aśoka Puṣyamitra Śunga, × the greatest oppressor of the Buddhists and Jains, usurped the throne of Magadha by slaying his master Bṛhadratha. His dynasty ruled from 184 B. C. to about 72 B.C. until the murder of Devabhūti the last king of the dynasty. In such mad persecution and dire calamity Jains must have naturally resorted to the Āchāryas noted for their magical prowess and great Mantrasiddhas like Susthita, Supratibuddha, Ārya Rohaṇa, Priyagrathisūri, Vidyādhara Gopāla † Revatimitra, Kālakācārya, Śrīgupta, Āryakhapuṭācārya and Upādhyāya Mahendra did or must have done what they could to protect the Jain fold. The effect of all this was however to increase the value of Māntrikas immeasurably in the eye of the people and therefore also in the eye of the Sādhus. Protection of Sangha and Caityas became the main duty of all whether laymen or monks. The importance of royal friendship and favour were also considered necessary at first for the protection and then for the spread of the Jain faith.

From all these necessities and the resulting atmosphere arose the Caityavāsis.

ŚRĪ VAJRASWĀMI

In the biography of Śrī Vajraswāmi we find that he also for some time made exception to the ideal rules of conduct for Sādhus and for a time helped his pupils with food obtained by his magical powers. We also find that employing Paṭa-Vidyā he removed the whole of the Jain Sangha from a town afflicted with famine, and carried the whole body flying over to another place named Puri. Further though a Jain Sādhu is not permitted to touch a flower even for worship of Jain idols, Śrī Vajraswāmi through his flying-lore flew over from place to place gathered flowers and brought them down for

× Śrī Kalyāṇavijaya identifies him with Kalki.

† Vidyādhara was not merely his family-name, as his family-name (Gotra) is additionally mentioned as Kāśyapa. He was therefore very probably a Vidyāsiddha and so came to be known as Vidyādhara and started Vidyādhari Śākhā of Sādhus.

being used for worship in Jain temples. The later Sādhus took all these as precedents and justification for their own laxity. They never cared however to take a lesson from his conduct in preferring death to taking food obtained through magic, but as mentioned in Āvaśyaka Nirukti vv. 1179–81 they preached that even Sādhus should worship Jain idols with flowers and other materials (i.e. perform Dravya-Pūjā) from the said example of Śrī Vajraswāmi and that such worship was one of the causes leading to salvation. They thus defended their own laxity. It may be assumed that till Vajraswāmi there was no Caitya-vāsa, but extreme devotedness to Caityas does appear from his biography. He is credited with deciphering of the flying-lore, through his miraculous intellectual power, from 'Mahaparijnā-Adhyayana' of Śrī Ācārāṅgasūtra.* He is said to have incorporated 'Pancamangala Mahāśruta Skandha' i.e. the sacred Panca Parmeṣṭi Mantra (which was formerly an independent Sūtra) in Mūlasūtras. It also appears as already stated that Śrī Vajraswāmi separated Vardhamāna Vidyā from Sūrimantra.+ It appears from Śrī Jinaprabhasūri's Vividha Tīrthakalpa that Śrī Vajraswāmi rearranged certain works extracted by Śrī Bhadrabāhu from Kalpaprabhṛta and also extracted others from Vijjāpāhuda which was a summary by Śrī Bhadrabāhu from the 10th Pūrva. These are said to have been abridged by Śrī Pādaliptasūri. All these facts go to show Vajraswāmi's great interest and proficiency in Vidyās and Mantras. It must also be remembered that according to Svetambara tradition, he was the last Āchārya versed in the ten Pūrvas, the tenth Pūrva being the Pūrva relating to Vidyās and

* जेणुद्धरिया विज्जा आगासगमा महापरिण्णाओ ।

वंदामि अज्जवहरं अपच्छिमो जो सुयहराणं ॥ आवश्यक निर्युक्ति, गा० ७६९ ॥

Śrī Munisundarasūri praises Śrī Vajraswāmi thus:

“या प्रज्ञा यच्च सौभाग्यं यः प्रभावश्च या मतिः ।

श्रीमद्ब्रह्मगुरावासंस्तानि नान्यत्र विष्टपे ॥ गुर्वावली, श्लो० २१ ॥

+ Śrī Candrasena Kṣamāśramaṇa, probably the grand pupil of Śrī Vajraswāmi, a great Māntrika is considered by some to have done this.

Mantras. * As such Āchārya he was expected to summarise or cull out important matters from the Pūrva in which he was the last man versed. Naturally, therefore, to Vajraswāmi are ascribed such works in the nature of summaries from the Pūrva literature styled Prābhṛtas. He was such a great Mantrasiddha that his name like that of Śrī Gautamaswāmi is invoked for obtaining food and other necessities of life. §

We have described above (pp. 152 ff. supra) Sārūpikas and Siddhaputras. It would appear that they were in existence much prior + to the rise of Caityavāsis and were probably concerned with the preservation and carrying on of the Māntric and Naimittika tradition of the ancient Pārśvāpatyas and Naimittikas. They also appear to have existed side by side with Caityavāsis as appears from Śrī Hari-bhadrāsūri's Sambodha Prakaraṇa. All the same they influenced Caityavāsi practices both being practitioners of Mantra, Vidyā and Nimitta. The real difference between Caityavāsis on the one hand and Sārūpikas and Siddhaputras on the other is that the former in spite of some of their lax practices were Sādhus while the latter were not. As Sādhus, Caityavāsis had their predecessors in the five kinds of lax Sādhus (of whom Kuśilas practised Vidyās, Mantras and

* Yativṛṣabha the author of Tiloyapannatti, a work well-known amongst the Digambara Jains, refers to 'Vairajasa' as the last of Pahṇasamaṇas (v. 70); and Prof. Hirālāl Jain of Amraoatī the learned author of the Introduction to and one of the Editors of Ṣaṭkhaṇḍāgama considers that this reference may be to Ārya Vaira mentioned in Śvetāmbara works as the latter mention him as possessed of Padānusāri Labdhi a miraculous power connected with intellect, which quality is also included in the term Pahṇasamaṇa see Āvaśyaka-Niryukti V. 767 "जस्स अणुष्णाए वायगतणे दसपुरम्मि गयरम्मि । देवेहि कया महिमा, पयाणुसारिं गमंसामि ॥"

§ The Mantra is: 'ॐ नमो भगवते श्री वज्रस्वामिने सर्वार्थ सिद्धिसंग्रहाय स्थानं भोजनं वन्नार्थलाभं देहि २ स्वाहा'

+ Hemacandrācārya describes Nārada as a Siddhaputra who would break up a sacrifice if the idol of Śrī Jina were not kept underneath the sacrificial post. See Pariśiṣṭha Parva, biography of Śrī Prabhavasūri.

Nimitta *) and Pārśvāpatyas above described. As practice of Mantras and Vidyās required certain facilities for Sādhanā, so they took their clue from Pārśvāpatyas. It would appear that as Śrī Pārśvanātha was especially worshipped by Pārśvāpatyas he came to be the Māntric deity par excellence of Jain Māntrikas.

As the Sādhus became more and more associated with temples, they naturally took part in the rites and ceremonies relating thereto as also in the installation ceremonies in performing which Mantras are usually recited. Taking part in such rites accompanied by Māntric recital, in the eye of the public, they came to be considered masters of magical lores. As men of the world wished for health, wealth and happiness, the aid of such Sādhus must have been freely sought but restrictedly given. Various facts which appear to have contributed to the development of Caityavāsa and its lax practices can be easily gathered from the biographies of some of the prominent Āchāryas of olden times.

We have noted above at pp. 174–175 how, the pupils of Ārya-suhasti, Śrī Sūsthita and Śrī Supratibuddha came to be known as Kauṭika and Mantravāda gained impetus with them. Ārya Rohaṇa was also a pupil of Ārya Suhasti and was a Mantra-siddha as shown below. Next came Priyagrānthīsūri whose Māntric achievements are described at P. 174 supra. Vidyādhara Gopāla and other Mantrasiddhas, who flourished about this time, we have already mentioned above.

All of them were famous as Mantravādīs and Mantravāda was one of the chief factors that helped the progress of Caityavāsa. Another factor was the establishment of contact with kings and through them realization of the ambition to spread Jainism. The effect was that the contact of Āchāryas with the rulers of the land culminated

* See Sambodha-prakaraṇa p. 13 v. 16.

कोडयभूर्कम्मे पसिणापसिणे निमित्तमाजीवी ।

कककदयाइ लक्खणमुवजीवइ विज्जमंताइ ॥ १६ ॥

usually into such intimate relations that the Āchāryas commenced accepting emblems of royal honour such as palanquin, elephant, horse, chowries etc. They thus became lax in observing the rules of conduct for Sādhus. We would give concrete instances. We have already mentioned how it became a practice to give such presents when Āchārya-ship was conferred upon a Sādhu as recorded in Nirvāṇakalikā of Pādaliptasūri. Pādaliptasūri himself had come in intimate contact with king Muruṇḍa of Pāṭliputra as also king Hāla or some other king of Sātavāhana Dynasty. He is also known to have possessed magical powers. A verse recording this fact is found in Niśītha Bhāṣya:

जह जह पएसिणि जाणुअंमि पलित्तओ भमाडेइ ।
तह तह सिसिरवियणा पणस्सइ मुरंढरायस्स ॥

He used to visit five Jaina Tīrthas flying daily. He was a poet, a novelist (having written the first novel Tarangavatī), and knew astrology and other branches of Nimitta Śāstra (science of Divination). In Gāthāsaptaśatī are found several verses ascribed to him (Pālitṭa). He composed 'Praśna Prakāśa', a work on astrological mode of answering questions as mentioned in Prabhāvākacaritra, the Prākṛta commentary on Jyotiṣkarandaka (see p. 26 same work with Malayagiri's commentary), and commentary on Kālaṅgāna (i. e. knowing approach of death before hand). His only available work is Nirvāṇakalikā already described above. According to Kalpacūrni Pādaliptasūri was a Vācaka. *

ŚRĪ KĀLAKĀCĀRYA

Some time prior to Pādaliptasūri flourished the famous Kālakācārya, who on abduction of his sister Sādhvī Sarasvatī by king Gardabhilla deposed him with the aid of Persian princes. There have been other Kālakācāryas before and after him with whom we are not here concerned. The Kālakācārya who deposed king Gardabhilla is said to have learnt the science of Divination (Nimittasāstra) from Ājīvakas and

* See Introduction to Ṣaṭkhaṇḍāgama p. 59 where the title 'Mahāvācaka' is considered the highest.

wrote a comprehensive work containing biographies and stories pertaining to Caritānuyoga, the first division of Jain literature and also started Gandikānuyoga i. e. Prakraṇagranthas versifying sūtras. He also changed Paryuṣaṇā Samvatsarī from the 5th of the bright half of Bhādrapada to the 4th of the bright half of the same month at the request of Sātavāhana the king of Pratiṣṭhānapura. + All these facts are referred to in Pancakalpacūrṇī, Niṣīthacūrṇī, Vyavahāracūrṇī Āvaśyakacūrṇī or Kalpacūrṇī.

With Śrī Kālakasūri's precedent Sādhus realised that when an important occasion arose they must have power and be prepared to redress the wrong to Saṅgha and Mantrasiddhis came to be valued more and more.

This deposition of king Gardabhilla by Śrī Kālakācārya was in 453rd year of Vīra era i. e. 17 years prior to the commencement of Vikrama era. Śrī Revatīmitra, Ārya Mangu and Ārya Samudra were his contemporaries. One incident in the life of Śrī Kālakācārya is important to us, as it shows his magical powers. It is that when accompanied by Persian princes, he came across a kiln where bricks were being baked, the Achārya sprinkled some magical powder on it, which put out the fire and turned the clay-bricks into gold-bricks. This supplied the Achārya and the Persian princes with sinews of war. It appears from the life of Śrī Kālakācārya that although he was strict in observance of the rules of conduct for Sādhus, he was bold and courageous enough to make a great exception, when he saw in the abduction of his ascetic-sister by the king Gardabhilla an insult to the Jain religion, and a danger to the Saṅgha, and went the length of leading an army and deposing the king. His example must have been looked upon by his contemporaries as well as successors with greatest regard and admiration. The real significance of the incident is that it must have impressed on Sādhus the very great necessity of possessing magical powers, by which even a king

+ According to some this was by a later Kālakācārya who flourished about 980 or 993 Vīra era and the King concerned was Dhruvasena of Ānandpur alias Vadnagar.

could be punished, if such an occasion arose. This must have given a great impetus to the practice of Mantras and acquisition of miraculous powers.

ĀRYA KHAPUṬĀCĀRYA

We see the same thing in the life of Vidyācakravarti * (Universal monarch of magical lores) Āryakhapuṭācārya. He flourished about the same time but must have been a younger contemporary of Kālakācārya. He died about the 484th of the Vīra era, and was a contemporary of Balamitra and Bhānumitra, Kings of Broach, who were the sons of the famous Kālakācārya's sister. As stated by the writer at page 11A of his introduction to Nirvāṇakalikā, "about the time the Buddhists had great influence in various courts of India and controversies between Buddhists on one side and Jains on the other were very common. Āryakhapuṭācārya and Upādhyāya Devendra (Mahendra) his pupil were Jain Sādhus well known for their learning and accomplishments in magical lores. One Buddhist from Gudaśastrapura, who was defeated by a Jain Sādhu in a controversy before the King of Broach, died and became a malevolent spirit and began troubling the Jains. The services of Āryakhapuṭācārya were requisitioned, and by his prowess he made the Buddhist Yakṣa (spirit) do his bidding and follow him out of the town. The king was thus won over, and the spirit gave up harassing the Jains. Devendra (Mahendra) similarly punished the jealous Brahmins in the Court of King Dāhada at Pātliputra by twisting

* See Viśeṣāvaśyakabhāṣya :

विज्जाण चक्रवर्ती विज्जासिद्धो स जस्स वेगावि ।

सिज्जिज्ज महाविज्जा विज्जासिद्धोऽज्जखउडुव्व ॥ ९३२ ॥

He who is accomplished even in one great Vidyā like Vidyāsiddha Ārya Khapuṭācārya is one who is accomplished i. e. adept in Vidyās or the universal monarch of the magical lores. Similarly verses 933 and 934 ibid say that one who is accomplished in a principal Mantra or several or all Mantras is a Mantrasiddha like the Sādhu who drew away columns of a royal palace and one versed in important magical powders or applications is a Drvyasiddha like Ārya Samiti, the maternal uncle of Śrī Vajraswāmi, who divided the river Benā to cross over to the other shore.

back the faces of the Brahmins by his magical prowess. When they promised to become Jain ascetics they were released and the King thenceforth never insisted on the Jain Sādhus bowing to the Brahmin householders. Both these preceptor and pupil were respectively versed in "Vidyā-Pāhuda" and "Siddha-Pāhuda". The said Āryakhapuṭācārya thus acquired great fame by protection of the ancient Jain Tīrtha at Broach known as Aśvāvabodha against the Buddhists. We may mention here that Āryakhapuṭācārya has been mentioned as a Vidyā-siddha twice in Niśīthacūrni. Srī Kalyāṇavijaya suggests that Dāhada might be Devabhūti, the last king of the Sunga dynasty who died in or about 72 B. C.

MANTRASIDDHAS

According to a statement in Sūrimantrakalpa Revatī (Circa 414–450 Vīra era), Rohinī-really Rohaṇa, a pupil of Ārya Suhasti, (Circa 300 Vīra era), Nāgārjuna, (Circa 813 to 891 Vīra era) Ārya khapuṭācārya (Circa 484 Vīra era) and Yaśobhadra are the five Āchāryas who are known as Mantrasiddhas obeisance to whom aids worshippers in acquisition of Mantrasiddhis. * Revatī is most probably Revatimitra + who was a Yugapradhāna-leader of the age, a famous Anuyogācārya contemporary with Kālakācārya (who deposed Gardabhilla), and flourished circa 414–450 Vīra era. No details of his life are known.

ĀRYA ROHAṆA

"Rohiṇī" as such we are unable to identify. It is probably a corruption of 'Rohaṇa' by some scribe owing to the name of Vidyādevī Rohiṇī being well-known and as it follows 'Revatī' which was possibly misapprehended as the name of a female.

This must be so because Āchāryaship is not conferred on a female ascetic. We find in one of the Mathurā inscriptions mention

* See Āvaśyakasūtra p. 509 A: अस्तीह जिणवराणं सिज्जंति पुत्रसंचिआ कम्मा ।

आयसिअ नमुक्कणेण विज्जामंता य सिज्जंति ॥ निर्युक्ति गा० १०९७

+ There has been a later Revatimitra who flourished circa 676 to 735 Vīra era.

of one Ārya Rohaṇa who founded a school-gaṇa. (See page 179 'On the Authenticity of the Jain Tradition' by G. Buhler). The said inscription is dated 98th year of king Vasudeva, i. e., the 2nd century A. D. and refers to Ārya Devadattagaṇi who belonged to the Gaṇa or Kula founded by Ārya Rohaṇa. It means that Ārya Rohaṇa must have been a spiritual ancestor of Ārya Devadatta. So considerable time must have passed between Ārya Rohaṇa and Ārya Devadatta. It appears from the same inscription that he must have also started 'Parihāsaka' Kula and 'Paurṇapatikā' Śakhā mentioned in the inscription. Ārya Rohaṇa is mentioned in Sthavirāvali of Kalpasūtra p. 166 (Devachand Lālbhāi Edn. with Subodhikāvṛtti) as the first of the 12 pupils of Ārya Suhasti. It is also stated therein that he started Uddeha gaṇa which had four Śākhās and six Kulas including Paurṇapatikā Śākhā and Parihāsaka Kula mentioned in the inscription. We have no more information about Ārya Rohaṇa.

Āryakhapuṭācārya, we have already described.

ŚRĪ NĀGĀRJUNA

Śrī Nāgārjuna here referred to could not have been the Rasa-Siddha* or alchemist who learnt the ingredients of Pādalepa (i. e. foot application) for flying from Śrī Pādaliptasūri as he is not known to have been initiated as a Jain Sādhu. He could not therefore have acquired accomplishment in Sūrimantra which is communicated by a preceptor to pupil only on conferment of Āchāryaship on him. He must be the famous Āchārya Nāgārjuna (circa 813 to 891 Vīra era) who is responsible for the Vallabhī Vācanā of the sacred scriptures of the Jains contemporaneously with Skandilācārya (circa 827 to 840 Vīra era) who was responsible for the Māthurī Vācanā and who is said to be of same spiritual line viz. Vidyādhara as that of Pādaliptasūri. There have been several Nāgārjunas and the one who started the Mādhyamaka school of Buddhists has nothing to do with Nāgārjuna of Vallabhi

* One who can convert base metals into gold with the help of special mercurial preparations.

Vācanā. There was also a later Buddhist Tāntrika named Nāgārjuna, who flourished in the 7th century of the Christian era. Kakṣapuṭa and Āścaryayogaratnamālā ascribed to Nāgārjuna are claimed to be the works of the Buddhist Tāntrika Nāgārjuna.

ŚRĪ YAŚOBHADRASŪRI

We make some observations about Śrī Yaśobhadrasūri at this place as he is one of the five Mantrasiddhas mentioned above although he flourished so late as the 10th century of the Vikrama era.

Śrī Yaśobhadrasūri belonged to Sāndera Gaccha and was not therefore a member of Caityavāsi Gaccha. He was however very famous as a Mantravādi. He was the pupil of Śrī Íśvarasūri. He was born of Prāgvāt parents Sāpu (of Nārāyaṇa Gotra) and Guṇi. His name was Sudharma. He lived with his parents at the Village of Palāsi in Rohai Khanda near Mt. Abu. As a child he took an ink-pot of a Brahmin co-pupil and accidentally broke it while replacing it. The Brahmin student insisted upon the identical ink-pot being returned. The demand could not possibly be satisfied by Sudharma and the Brahmin student vowed that he would eat rice-meal in the skull of Sudharma. The latter retorted "If I am a true Bania I would kill you even if dead." The said Íśvarasūri being in quest of a good pupil worshipped a deity named Badarī who informed him that the said Sudharma was a fit pupil to be initiated and become his successor. Thereupon Íśvarsūri came to Palāsi village and initiated the said Sudharma. Then they went to Mudāhada town and Āchāryaship was there conferred on Sudharma, and at the time his name was changed to Yaśobhadrasūri and Badarīdevī promised to help him. Then they came to Pāli for stay during the monsoon when the Sun-god was pleased with Yaśobhadrasūri and gave him a boon promising to fulfil all his desires. Íśvarasūri died there during the monsoon and as soon as it was over Yaśobhadrasūri with his co-pupil Balibhadrasūri went to Sānderā and there in a new temple installed the idol of Śrī Sre-yāṅsanātha in s.y. 969. In the same year as a result of Yośobhadra-

sūri's preaching another temple was constructed at Mudāhada. In the Sangha-dinner given at Sānderā on the occasion of the installation ceremony Ghee (clarified butter) used for preparing food was exhausted owing to a very great number of people unexpectedly attending the dinner. The Āchārya, at the request of Dhanrāja the leading layman managing the function, through the aid of Vīras (Powerful Māntric deities) obtained 'Ghee' immediately from Pāli though much distant. On the third day Dhanrāja reached Pāli and offered to pay for the 'Ghee' to the merchant there. The latter having learnt the object for which it was utilised refused to take the moneys and the same were given in charity at Pāli by Dhanrāja. Yaśobhadrasūri visited Āhada, Khamaṇūra, Karheṭaka, Kavilāṇa, Bhesūra and other places and by his preachings made many to embrace the Jain faith. Yaśobhadrasūri came from Chitor to Āhada i.e. Aghata at the request of the minister of Āhada and installed the idol of Śrī Pārśvanātha in the temple constructed there. The said Balibhadrasūri cured the Queen of Āhada who was possessed by a malignant spirit named Revatī. Ultimately he came to Nādalāi for stay during monsoon. The Brahmin student being too poor to maintain himself became pupil of a Kānafattā Yogi (i.e. a follower of Nātha Yogis, one who puts on big thick rings in large holes made in the centre of the ears) and learned black magic. Searching for the Bania student he came upto Nādalāi and came to the place where the Āchārya was preaching. He produced serpents from his matted hair and there was a panic amongst the hearers there. The Āchārya recognising him as his old co-pupil produced with the aid of Badarī deity from strips of his mouth-cloth mungeese and the serpents immediately disappeared. The Yogi thus baulked of his object went away thoroughly disappointed. Then there was a competition between the two to bring temples from other towns and the Āchārya brought down from Kāntinagara and Vallabhi towns the temple of Śrī Ṛṣabha and the Yogi brought down a temple of Sambhu. Then the Yogi made the faces of the Jain idols distorted

and the Āchārya by giving them bath of Māntric-waters restored them to their original appearance. Then the Yogi made the columns and the seats in the temple quake and the Āchārya stabilized them with his magical powers and brought down the cupola from the turret of the temple of Sambhu. Yaśobhadrasūri died in 971 Vikrama era according to Vīravamśāvali but 1029 Vikrama era according to "Aitihāsika Rāsa Sangraha Part I". When his body was placed on the burning pyre the Yogi brought down rains to extinguish the fire and obtain the natural gem from the skull of the Āchārya, but the rain was intercepted by a cover raised on the pyre and Badarīdevī, who was angry at the hostility of the Yogi even to the dead Āchārya, threw him on the burning pyre and he died.

Śrī Kalyāṇavijaya says at page 73 of his introduction to Pra-bhāvaka-caritra that according to Pattāvalis Caityavāsis arose in 882 Vīra era, i. e. 412 Vikrama era but that really it is the date when they had gathered great strength and much power and influence and had outnumbered Sādaus who were observing strictly the rules of conduct laid down in the scriptures for them. He further says that according to statements in Bhāṣyas and Cūrnīs on Jain Sūtras Caityavāsis appear to have been in existence even before the said date. That the decadent times helped the growth of Caityavāsis would appear to be probable from the fact that according to Vincent Smith "The period between the extinction of the Kushān and Andhra dynasties about 220 or 230 A. D., and the rise of the imperial Gupta dynasty, nearly a century later, is one of the darkest in the whole range of Indian history." (P. 257 Early History of India).

ŚRĪ MĀNADEVASŪRI

Śrī Mānadevasūri flourished from the end of the 2nd century to 261 Vikrama era. His grand preceptor Devasūri, before Āchārya-ship was conferred on him by Sarvadevasūri, was known as Upādhyāya Devachandra and managed the temple of Śrī Mahāvīra at Korāṇṭaka alias Korāṭā in Mārwar. This, if true, establishes the existence of

Caityavāsis in the beginning of the 3rd century of Vikrama era, Mānadevasūri having died about 261 Vikrama era.

At the instance of Śrī Sarvadevasūri, Upādhyāya Devachandra gave up the management of the temple and commenced observing the rules of conduct for the ideal Sādhu, and ultimately Āchāryaship was conferred on him. It is said in the biography of Śrī Mānadevasūri that in his time there were 500 Jain temples at Takṣaṣilā (Taxilā) and that there was a great population of the Jains at that place. Once there was a great epidemic at Takṣaṣilā and the Jain Sangha having assembled to learn the cause thereof and its remedy was informed by the Śāsanadevī that the only remedy was to approach Śrī Mānadevasūri at Nāndol in Mārwar. Śrī Mānadevasūri was such a Mantrasiddha that deities Jayā and Vijayā used to remain in attendance upon him. Śrī Mānadevasūri having been requested to help the Sangha composed Śāntistava containing Mantrādhirāja (Mantra of Śrī Pārśvanātha as propounded by Kamaṭha) and Mantra of Śrī Śāntinātha and informed the representative Vīracandra, who had come there at the instance of the Sangha of Takṣaṣilā, that the epidemic would end and would not harm those who would recite the said Stotra and sprinkle round about their residence water over which the hymn was recited. The said Stotra is now known as Laghūśānti to distinguish it from the Bṛhadśānti (big Śānti) of Vādivetāla Śāntisūri. He has also composed a Sūrimantra-Stotra published in appendix A hereto. There was a later Mānadevasūri a contemporary and friend of Śrī Haribhadrāsūri, about whom it is said that he having forgotten Sūrimantra learnt it again from Śrī Ambikādevī.

As it would be interesting to investigate since when the Sādhus commenced taking up residence in temples, we would note here the following facts.

At page 318 B of Āvaśyakasūtra with Haribhadrāsūri's commentary, it is stated that Śrīguptācārya (Circa 533-548 Vira era) resided at a temple (of Vyantara deity) named Bhūtagṛha or Bhūtaguhā in the town named Antaranjikā. This gives us a clue to the practice

of Jain Sādhus taking up residence in Caityas or temples of non-Jain* deities before they commenced doing so in Jain Caityas. Srīgupta was an Upādhyāya and should not be confounded with a pupil of Ārya Sūhasti bearing the same name. This Srīgupta was versed in several Vidyās, and taught them to his pupil Rohagupta, who had accepted the open challenge of an ascetic for a religious controversy. The said pupil succeeded in the bout both intellectual as well as magical. He would not however admit at the instance of his said preceptor Srīgupta that Jains did not believe in the Trirāsika principles propounded by him as a stratagem to defeat his shrewd adversary and was driven out of the fold. We may, therefore, infer that sometime after expiry of Vajraswāmi in the 2nd century of Vikrama era Caityavāsa became common and continued to be more common until it gathered great strength about s. y. 412 as noted in Pattāvalis, and as noted in the biography of Srī Siddhasenācārya the latter accepted palanquin and elephant from king Devapāla.

ŚRĪ SIDDHASENA DIVĀKARA

Srī Siddhasenācārya was a grand-pupil of Skandilācārya, famous for Māthurivācanā. He must be therefore taken to have flourished not earlier than the 5th century of Vikrama era. Some put him down even to the 5th or 6th century A. D. He wrote a Bhāṣya or a versified commentary on Niśītha Sūtra. His name also occurs in Mahaniśītha-sūtra. He is referred to in Niśīthacūrni, which is a work of the 7th century of the Vikrama era, as Siddhasenakṣamāśramaṇa and Siddha-

* See Jnātādharmakathāṅga P. 107 A for practice of Jain Sādhus taking up residence temporarily. The places mentioned include Devakulas i. e. Caityas which there mean non-Jain temples: “सुया ! जन्म आरामेसु उज्जाणेषु देवउलेसु सभासु पम्वासु इत्थिपंडगविबज्जयासु वसहीसु पाडिहारियं पीठफलगसेज्जासंथारयं उग्गिण्हत्ताणं विहरामि सेत्तं फासुयविहारं ॥” i. e. Oh Suka ! that is harmless (not involving injury to living beings) residence which is taken up by us in gardens, parks, temples, meeting-places and places for supplying drinking water, not frequented by women and eunuchs, where seats, sleeping boards and grass beds are only borrowed for use.

senāyariya. From several references in the same work it appears that he must have written Bhāṣyas or commentaries on the Jain canon. At one place in Niśīthacūrni, it is stated that he created horses by a magical process contained in Yoniprābhṛta. It is also stated about him that from a column at Chitor, he obtained a book on magic and read a page containing methods to prepare gold from base metals and create warriors. It really means that the Āchārya was versed in magical lores and that he helped a king-friend to overcome his enemies. That is the reason why he got the name of Siddhasena i. e. one possessed of magical army. He also composed the famous Kalyāṇa-mandira stotra, which he recited, when a king insisted on his making obeisance to Mahādeva, and on his reciting the 13th verse, there appeared the idol of Śrī Pārśvanātha from out of the phallic Śiva. A Māntrika hymn imitating Śakrastava praising Śrī Jina by various epithets is also ascribed to him. * At the beginning of his life he expressed a desire to translate all Prakṛta scriptures into Sanskrit, which offended his preceptor and the Saṅgha and he was excommunicated for twelve years, the condition of re-admission being that he should do something, by which the reputation of the Jain religion may be greatly enhanced in the estimation of others. He fulfilled the condition. He was since known as Divākara. He was a great poet and composed Dvātrimṣikās. He was a great controversialist and composed the famous Sanmatitarka. He made several kings accept Jain faith by his magical prowess and he was thereupon re-admitted to the Jain fold. There is no doubt that in his time Caityavāsis had already gathered great strength, otherwise an Āchārya of his attainment would not have dared to ride an elephant and use a palanquin. It would also appear that Caityavāsa and Mantravāda were going hand in hand.

ŚRĪ MALLAVĀDISŪRI

In the biography of the famous logician Śrī Mallavādisūri who

* See Bhaktāmarādistotratryam (Devachand Lalbhai Edn. No.79) PP. 242-245. Note the epithets 'Sarvamantramayāya' and 'Siddhasenādhināthāya' given to Śrī Jina.

flourished in the 5th century of Vikrama era, it is stated that he conquered in debate the Bauddhas and their Vyantaras* (deities) also. It is said that this Mallavādisūri had obtained a boon from Sarasvatī after six months worship in the cave of a mountain named Girikhanda. He composed Nayacakrasāra, by virtue of the said boon, based on the single verse which he was allowed to read of the original work on Naya, by Sarasvatī. He was thus a great Māntrika. He also wrote a commentary on the famous Sanmatitarka of Śrī Siddhasenācārya.

TEMPLE-BUILDING ACTIVITY IN THE 6th & 7th CENTURIES.

The importance given to Jain temples from the time of Samprati rose gradually; and whenever a Jain Āchārya succeeded in bringing a king into the Jain fold we find that grand temples were constructed at different places by such king. We find great activities of temple-building going on in Gujarāt as a result of the preachings of the predecessors of Dākṣiṇyacinha the author of Kuvalayamālā in or about sixth and seventh centuries of the Vikrama era. In the colophon of Kuvalayamālā it is said:—"There are two regions and only two countries—Uttarāpatha and Dakṣiṇāpatha; amongst them Uttarāpatha is the country full of learned men. In Uttarāpatha there was a prosperous town named Pavvaiyā (Parvatikā) on the beautiful shores of the river Chandrabhāgā (Chenāb), which was like the beloved of the Sea with a lotus-like face. It was the capital of King Torarāja (v.l. Toramāṇa). His preceptor Hariguptācārya of Gupta dynasty had taken up his residence there. His pupil was the great poet Devagupta. (Devagupta's pupil) Sivacandra Mahattara went on pilgrimage from place to place for making obeisance to Jinas. He ultimately stayed like the wish-granting tree at Bhillamāla. His pupil Yakṣadatta Gaṇi, possessing qualities of a Kṣamāśramaṇa and a Mahātmā, was very famous. His many pupils possessed of miraculous powers of speech, austerity and

* श्री वीरवत्सरादयः शताष्टके चतुरशीतिसंयुक्ते ।

जिग्धे स मङ्गवादी बौद्धास्तव्यंतरांश्चापि ॥ प्रभावकचरित्र, पृ. ७५, श्लो० ८३ ॥

strength of soul adorned the country of Gujarāt with temples. Of them the chief were Nāga, Vinda, Mammaṭa, Durga, Āchārya Agniśarmā and the sixth Vateśvara. Vateśvara got a beautiful Jain temple constructed at Ākaśavapra* seeing which even an angry man would be calmed. Another pupil of his named Tattvācārya was possessed of the lustre of austerity and character, with which he destroyed sin and darkness of ignorance—true to his name like the Sun; and his pupil (Udyotanasūri) bearing the appellation of Dākṣinyacinha has composed this story of Kuvalaymālā being inspired by the sight of Hrīdevī. † “Āchārya Virabhadra and Haribhadra were his Vidyāgurus the former in respect of sacred scriptures and the latter in respect of logic. From a coin found by Cunningham bearing words ‘Śrī Mahārāja Hariguptasya’ on the obverse and a Kalaśa with flowers i.e. Kumbhakalaśa on the reverse, and from the fact that such a Kalaśa is unmistakably the sign of Jainism, it appears that he must be a Jain. As the coin is supposed to belong to the sixth century of the Vikramā era he must probably be the same as Hariguptācārya mentioned in the colophon quoted above and a contemporary of the famous Toramāṇa of the Hūṇas. The readers will note that the temple building activity was a special characteristic of Caityavāsīs and that it was thus carried on in the 6th and 7th centuries of the Vikrama era.

* This is modern ‘Vadnagar alias Ānandpur in Gujarāt’ according to Śrī Jinavijaya but ‘Amarkot alias Ambarkota’ on the border of Sind according to Śrī Kalyāṇavijaya.

† According to Ācāradinakara pp. 235 ff. Śrī, Hrī, Dhṛti, Kīrti, Buddhi and Lakṣmī are the six deities who are invoked to bring prosperity to the worshipper. Of the well-known six objects of Māntric worship they are worshipped for Puṣṭi: “श्रीह्री-धृतयः कीर्तिर्बुद्धिर्लक्ष्मीश्च षष्महादेव्यः । पौष्टिकसमये संघस्य वाञ्छितं पूरयन्तु मुदा ॥” See loc. cit. for Dhyānas of Hrīdevī and the other five deities. ह्रीदेवी यथा—“धूम्राङ्गयष्टिरसिखेटकबीजपुरबीणा-विभूषितकराधृतरक्तवस्त्रा । ह्रीर्घोरवारणविघातनवाहनाढ्या पुष्टीश्च पौष्टिकविधौ विदधातु नित्यम् ॥” So, Śrī Bhagavatīsūtra, IX Śataka, 11 Uddeśa, 430 Sūtra records a present of the idols of these six deities on the occasion of marriage.

ŚRĪ MĀNATUṄGASŪRI (Circa 7th Century A. D.)

We then come to Śrī Mānatuṅgasūri who was a contemporary of Bāṇa and Mayūra and composed Bhaktāmarastotra to show that the Jains also possessed magical powers. Mayūra composed his famous hymn in praise of the Sun to remove leprosy from which he was suffering. Bāṇa Vying with him composed his famous hymn Candīśataka in praise of Candi through whose favour his hands and legs which had been got amputated were miraculously joined to his body as if nothing had happened to him. Mānatuṅgasūri was invited by the king to his Court at the instance of his minister who had informed the former that the Jains also possessed miraculous powers. Mānatuṅgasūri when requested in the Court to show some miracle said: "Like house-holders we do not do anything of the sort for money having taken a vow of poverty, but merely to show that Jains are not devoid of such powers I also shall perform a miracle." He asked the king to put him in a prison chained and locked with as many locks as he liked. It is said that 48 locks were put on the chains and he was locked up in a prison. He then commenced composing the famous hymn in praise of Lord Ṛṣabhadeva now known as Bhaktāmarastotra which originally consisted of 48 verses. As he composed and recited each verse one of the locks broke open till all of them broke and the prison doors also flew open and he walked out amidst the applause of all. He has also composed the famous Bhayaharastotra popularly known as Namiuṇa stotra. It contains the famous Cintāmaṇimantra of Śrī Pārsvanātha. It is intended to remove all kinds of fear and diseases. He has also composed the famous Panca-Parameṣṭi stotra called 'Bhattibbhara' from its first words. This Āchārya flourished in the 7th century of the Vikrama era being a contemporary of the King Śrī Harṣa. The tendency to impress and win over kings through miraculous powers and by their friendship to propagate the Jain religion can be noted in Mānatuṅgasūri's biography. His performing the miracle mentioned above would not be justified

according to the strict rules of conduct to be observed by Sādhus as the only exception recognised is that in times of great calamity to the Jain fold such powers may be exercised without committing sin. Perhaps justification might be urged that the result of the performance in the Court would contribute greatly to the spread of Jainism but such exception is not recognised in the strict rules of conduct for Jain ascetics. It is an illustration of the tendency of the times and influence of Caityavāsi Sādhus.

In brief, temple building activities, recurring famines, foreign invasions, internal feuds and unwillingness to undergo hardships incidental to acting upto the ideals of Sādhu's conduct, Sādhus taking up residence in population instead of forests, contact and friendship with kings, anxiety to protect Jainism from the onslaughts of rival religions, desire to succeed in constant debates, necessity of magical powers to meet disputants belonging to rival religions who were reputed to be Tāntrikas possessing magical powers, all jointly and severally contributed to the rise and continuance of the Caityavāsis for nearly a thousand years.

ŚRĪ HARIBHADRASŪRI (Circa 8th Century A.D.)

We have to note here that at no time during the period of nearly one thousand years Caityavāsis were so powerful that they could completely overwhelm or root out the ideal Sādhus. Although the latter were comparatively few in number, they existed side by side; and when by sheer strength of character and learning a member of the latter class rose to leadership Caityavāsis did suffer a set-back for a time. The famous Haribhadrāsūri is the Āchārya who so opposed the Caityavāsi's lax practices, although it is said that he himself arranged for food being given to the hungry and a conch used to be blown inviting the hungry to meals before he would himself partake of food—which practice is not in conformity with the vow of poverty i.e. not to have any belongings. Some explain this practice by saying that it was not Śrī Haribhadrāsūri himself but a Srāvaka—

a layman devoted to him who used to distribute food as stated above. This Haribhadrasūri appears to have been himself a great Māntrika. * He defeated the Buddhists who were assisted by their Patron-deity 'Tārā' in debate. He had on his side the Jain Āmnāya deity Śri Ambikā to help him through. There is one tradition about him which says that when he learnt of the death of his two favourite pupils, who had gone to the Buddhists to learn their scriptures, at the hands of the Buddhists he with his great magical powers drew them flying through the air to be dropped in a pan of boiling oil but desisted when reminded of the sin he was about to commit by his preceptor who sent three verses for his benefit showing the consequences of such revenge. It is said that he composed his famous "Samarāiccakahā" on the basis of the said verses to atone for his sinful resolve.

The generality of the Sādhus in his times was however unwilling to undergo the hardships incidental to the ideal ascetic life prescribed in the scriptures and took up their residence in particular temples and sometimes in separate houses termed Maṭhas. As already noted they had formed themselves into a Gaccha known as Caityavāsi Gaccha. Their activities have been well described by Śri Haribhadra-sūri in his Sambodhaprakaraṇa (pp 13-18). One should not, however, from the said description jump to the conclusion that all Caityavāsis were from the beginning so lax in every respect. The fact is that once liberties commence to be taken the habit grows and gathers strength and what was originally perhaps a venial transgression becomes an unpardonable sin. We have not sufficient materials to show this development through all its stages. We have noted and would note the various exceptions made and liberties taken from time to time as appears from the biographies of different Āchāryās who were otherwise great and even now command respect.

* In his commentary on Āvaśyakasūtra at p. 411 he mentions Ambā Kuṣmandī and Hariṇegameṣī as instances of Vidyās and Mantras respectively and Maha-puruṣadattā as an instance of Mahāvidyā.

ŚRĪ SĪLAGUṆASŪRI (Circa 8th century A.D.)

We then come to the times of the famous Sīlaguṇasūri who brought up under his personal care the famous Vanarāj of the Chāwdā dynasty who founded Anhilapurpātan in s.y. 802. In Prabhāvaka Caritra the name of the Āchārya who brought up Vanarāj is given as Devacandra. This Devacandra was himself a pupil of Śrī Sīlaguṇasūri and it might be that he took charge and care of Vanarāj under the orders of Śrī Sīlaguṇasūri. According to the inscription No. 510 in the 2nd volume of the Inscriptions collected by Śrī Jinavijaya he was a pupil of Sīlaguṇasūri : “श्रीचापोत्कटवंशोद्भवमहाराजश्रीवनराजगुह श्रीनागेन्द्रगच्छे श्रीगुणसूरिशिष्यश्रीदेवचंद्रसूरिमूर्तिः” This suggests that the idol bearing the inscription was of Śrī Devacandrasūri and that he was the preceptor of Śrī Vanarāj. According to Śrī Prabhāvakacaritra, Vanarāj had given a writing to the Caityavāsi Sādhus that only those Sādhus who were permitted by the Caityavāsis should stay in his capital and others not so permitted should not stay. Caityavāsis were considered as Kulgurus (i.e. family-priests of Chāwdā dynasty) as appears from the following Duhā (couplet). It also shows that there were other Gacchas also at that time such as Sandesarā, Chaudasiyā (as distinguished from Paurṇamikas) and others known to be family-priests of other royal dynasties:

“शिसोदीया संडेसरा चउदशिया चोहाण ।

चैत्यवासिया चावडा कुलगुरु एह वस्त्राण ॥”

P. 188 Short History of Jain Literature,
by M. D. Desai.

ŚRĪ BAPPABHATTISŪRI

We then come to Śrī Bappabhattsūri alias Bhadrakīrti. He was a great poet and also a great dialectician and has composed several stotras of which Caturaviṃśati-Jina-Stuti and hymns to Sarasvatī * and Santidevatā only are available. He lived from 800 to 895 Vikrama era.

* See appendix 12 hereto; the hymn referred to in Prabhāvakacaritra is not available. He has also written a Sarasvati-Mantra-Kalpa. See appendix 12.

The most noteworthy feature of his life is his intimate friendship with king Āma and that is the reason why he was called Rājapūjita. He was also friendly with a king named Dharma of Gaudadeśa whose capital was Lakṣaṇāvati. He was a contemporary of the famous poet Vākpatirāja. Śrī Bappabhatti got temples constructed at Kanoj and Gwālior by king Āma. He defeated the Digambaras in a peculiar kind of debate which necessitated possession of great magical powers on the question of the right of precedence in worship at and the ownership of the Girinār Tīrtha. It also appears that Śrī Bappabhatti and his co-pupils used to reside in Jain temples. Bappabhatti and his pupils are said to have resided in a temple named Āmavihāra. He composed 52 literary Prabandhas one of them being Tārāgaṇa reference to which is made by the Jain poet Dhanapāla in his work Tilakamanjarī.

ŚRĪ SIDDHARŚI ŚRĪ VĪRAGAṆI AND ŚRĪ ŚĀNTISŪRI

We have already mentioned that although Caityavāsis were in power they had not completely rooted out those who were still following strictly the rules of conduct laid down for Sādhus. Śrī Siddharśi is an instance. He wrote his famous Upamitibhavaprapañcakathā in s. y. 962. He used to give religious discourses sitting in the Agramaṇḍapa of Jain temples. Although it was the practice in former times to give religious lectures in the Agramaṇḍapa of Jain temples and although there was nothing objectionable in it from the scriptural point of view, it being wrongly taken to be one of the activities of Caityavāsi Sādhus was stopped by the reformists. Similarly there were such Sādhus as Śrī Vīragaṇi who were ideals of renunciation and asceticism. He was a Māntrika all the same and learnt Aṅgavidyā* together with Gaṇavidyā from Vimalagaṇi through his book kept in the niche in the dome of a temple. According to Śrī Kalyāṇavijaya he must have flourished in the 11th century of Vikrama era and not in the 10th as stated in Śrī Prabhāvakaritra.

* According to Himvat Sthavirāvali Balissaha a pupil of Ārya Mahāgiri extracted Aṅgavidyā from the 10th Pūrva. See p.174 Vira Nirvāṇa Samvat and Jain Kāla Gaṇanā.

Coming to the famous Āchārya Vādivetāla Śrī Śāntisūri, we find that on his defeating 84 disputants in the Court of king Bhoja he got the said title of Vādivetāla and 84 lacs of Mālvī rupees equal to 12,60,000/- rupees of Gujarāt. He had obtained such miraculous powers by virtue of a boon from Sarasvatī that he could make even inanimate objects carry on successful debates and could silence all opponents merely by raising his hand while debating. He spent all the moneys in getting Jain temples constructed. He is the author of the famous Bṛhadśānti containing Mantras for peace and prosperity which is even now recited by Jains in their periodical expiatory rites namely Pratikramaṇas. This shows that he was versed in magic. It is noted in his biography that once he cured through his Māntric powers, the son of a Jain merchant bitten by a serpent and given up as dead. * In his biography his place of residence is twice called Maṭha. One may, therefore, infer that there was laxity in observing the ideal rules of conduct for Sādhus, particularly in respect of residence, in the Gaccha to which he belonged. He died in 1096 Vikrama era.

ŚRĪ SŪRĀCĀRYA (Circa 11th century A. D.)

We then come to Śrī Sūrācārya who was the son of King Saṅgrāmasinha and bore the name of Mahīpāla as a house-holder. His paternal uncle was the famous Droṇācārya. Mahīpāla's mother, having lost her husband early during the childhood of Mahīpāla, entrusted him to Droṇācārya who made him versed in all the branches of learning and initiated him as his chief pupil and gave him the name Sūrācārya. The said Droṇācārya was the maternal uncle of king Bhīmadeva of Pātan. Sūrācārya was a highly intelligent scholar well versed in logic and poetics but was rather proud and of angry temperament.

* From this fact we infer that he was rightly called Gandharva as the title used to be given in ancient times to one versed in curing persons bitten by serpents through magical powers. Śrī Kalyānavijaya thinks that Gandharva Vādivetāla Śāntisūri was a contemporary of Śrī Devardhigaṇi and assisted him in Āgamavācanā, we should think, on insufficient evidence-See Vīra-Nirvāṇa Samvat and Jain Kāla Gaṇanā p. 118.

He was scolded by his preceptor for being cruel to his pupils and taunted that if he was so anxious to make his pupils great disputants why did he not himself go to the Court of Bhoja and defeat his famous disputants. On that he vowed to do so and ultimately went there and defeated all the disputants of the Court of King Bhoja. He was not, however, discreet and pointed out mistakes in the work on grammar composed by the king himself and would have been punished for his audacity but with the help of the poet Dhanapāla he secretly escaped from his Ūpāśraya and safely reached Gujarāt. He was a Caityavāsi as in fact his grand preceptor Govindasūri owned a Jain temple at Pātan where male as well as female dancers used to dance on ceremonious occasions such as Parvas. When he entered the town of Dhārā and also on his return to Pātan he rode an elephant. All this goes to show how Caityavāsis flourished at the time at Pātan.

ŚRĪ JINEŚVARASŪRI

We would now note the fact that Śrī Jineśvarasūri defeated in debate Caityavāsi Sādhus at Pātan in the presence of King Durlabharāja in s. y. 1080. According to the followers of Kharataragaccha the leader of the Caityavāsis who lost in the debate was Sūrācārya. At the date however Durlabharāja was not the ruler of Pātan. From this day reformists gained ascendance and Caityavāsis became gradually extinct.

Although Caityavāsis met with a reverse in or about s. y. 1080, they did not all disappear from the scene at once. For over a hundred years thereafter we hear about them in some connection or other. Their influence however continued for a long time thereafter and a gradually increasing number of Sādhus continued to be lax in the observance of the rules of conduct laid down for Sādhus; and ultimately about 300 years back they were distinguished under the name of Yatis or Jatis. These may with some justification be called the successors to Caityavāsis as the latter as also Sārūpikas and Siddhaputras were of Parśvāpatyas, Naimittikas and the five kinds of fallen Sādhus viz. Pāsattas,

Avasannas, Kuśīlas, Saṃsaktas and Yathacandas. Reforms were introduced from time to time by various Āchāryas like Śrī Jagaccandrasūri, who received the title of Tapā by his great austerities and founded the Tapāgaccha and Śrī Hīravijayasūri of Tapāgaccha and Śrī Jinacandra-sūri of the Kharatara Gaccha in Akbar's time and lastly by Pannyāsa Śrī Satyavijaya (s. y. 1674 to s. y. 1756)* amongst the followers of Tapāgaccha and by Śrī Kṣamākalyāṇa amongst the followers of Kharatara Gaccha. But Yatis and their chiefs called Bhaṭṭāarakas have continued side by side with varying fortunes all the same. They might be compared with Caityavāsīs and Sārūpikas of olden times. They put on the white garments of Sādhus but would practice Vidyā, Jyotiṣ and Cūrna i. e. Magic, Astrology and Medicine. They lost most of their influence and power over the Jain laity since the advent of Śrī Ātmārāmaji alias Vijayānandasūri. They however still exist in comparatively small number and practice Medicine, Astrology and Mantra. The western education, the modern atmosphere and the activities of the other Sādhus have taken away most of their adherents. Generally the backward sections of the Jain population residing far away in small towns and villages beyond the influence of modern civilization and education still support them. Some of them have their hereditary Jāgirs and allowances conferred on them by States for services rendered in the past by their predecessors. They earn their livelihood otherwise by practice of medicine. It should not be understood however that the reformed Sādhus did not or do not believe in Mantras. They are required for religious purposes to do Japa at least of Vardhamānavidyā or Panca Parmeṣṭi Mantra. The Ācāryas have to do Japa of Sūrimantra. The difference is in theory only, and it is that the reformed Sādhus are to be real Adhyātmikas and are not therefore to practice Mantras for gaining worldly prosperity or happi-

* The reformed Sādhus of Tapāgaccha since his time and those of Kharatara Gaccha from the time of Kṣamākalyāṇa commenced putting on yellow garments instead of white to distinguish themselves from others who continued their lax practices. These are known as 'Saṃvegīs.' Sādhus of Kharatara Gaccha have resumed putting on white garments.

ness either for themselves or others. All however do not strictly observe this restriction and the conduct of those amongst Samvegī Sādhus also who take liberties in this respect is not approved of by ideal Sādhus. The fact however that Mantravāda existed and exists amongst Jains cannot be denied by anyone.

We would here note the names of the famous Jain Māntrikas * who flourished since 1080 Vikrama era about which time the Caityavāsīs were defeated in the debate as already stated. Yaśobhadrasūri of Sāndera Gaccha, who died in 1096 Vikrama era we have already mentioned—(See supra pp. 194 et seq.) Abhayadevasūri, Vīrācārya, Jinadattasūri, Vādi Devasūri, Hemacandrācārya, Malayagiri, Devendrasūri of Nāgendra Gaccha of Serisā–Tīrtha fame, Śrī Pārśvadevagaṇi alias Candrācārya (Circa 1203 s.y.) author of Upasargaharavṛtti and Padmāvatyāṣṭaka-Vṛtti, Sāgaracandrasūri, Amaraandrasūri the author of Bāla Bhārata and several other works, Bālacandrasūri, Dharmaghoṣasūri of Tapāgaccha, the Guru of Pethadashāh who became very famous by his charities, Devabhadragaṇi author of Pratyangirā-Kalpa in Prākṛta, Pūrṇakalaśagaṇi author of Śrī Stambhana-Pārśva-Jina-Stavana with commentary (circa 1307 s. y.) Jinaprabhasūri, Jinakuśalasūri, Bhuvanatuṅgasūri and Merutuṅgasūri of Ancalagaccha, Munisundarasūri Subhasundaragaṇi, Hemavimalasūri, Jinacandrasūri (of Kharataragaccha, a contemporary of Akbar),

* It is not possible to give an exhaustive list, as almost all the Sādhus of note who wrote any work in Sanskṛta, Prākṛta, Apabhraṃsa, or Gujarāṭi include obeisance to Sarasvatī in the opening benedictory verses. Some like Āmradeva and others are known as having their distinctive Mantras for worship of Sarasvatī, but no Māntric works of theirs are available nor any miraculous achievement of theirs known to us. Even such a prominent personality as Śrī Hīravijayasūri though known to have been opposed to performance of miracles or fortune-telling was a Māntrika he having achieved accomplishment in Sūrimantra. (See Hirasaubhāgya poem cantos VII to IX) Amongst Digambara Jains, besides the author of the present work, Śrī Malliṣeṇasūri, there were before him Śrī Elācārya alias Helācārya (who first composed, Jvālāmālinī-Kalpa) and Śrī Indranandi and after him Śrī Śubhacandrācārya author of Jnānārṇava and, Bhaṭṭāraka Śubhacandrācāryā author of Ambikā-Kalpa and others.

Upādhyāyas Śānticandra, Yaśovijaya and Meghavijaya, and Vīravijaya the poet who composed several Gujarāti Rāsās and Pūjās, lyrical poems, Sajjāyas and Stavanas (hymns). Coming to the modern times Śrī Mohanlālji, as a memorial to whom a library and Pāthaśāla are even now being conducted in Bombay, was a famous Māntrika. He died at Surat in 1963 Vikrama era. Amongst contemporary personages who have the reputation of being Māntrikas we may mention the famous Yogīśvara Ācārya Śrī Śāntivijayaji who is 'Guru' to several rulers of the Native States of India. Only a few years back H. M. the king of Nepāl sent a deputation to wait on him and honour him as 'Rājaguru' of Nepāl. We may also mention Śrī Jayasiṃhasūri who has drawn all the Yantras in this work and other works like Mahāprābhāvika Navasmarāṇa, Mantrādhirāja Cintamaṇi etc. published by the publisher of the present work. The writer has come in close contact with Śrī Jayasiṃhasūri and has great regard for his knowledge of Mantraśāstra and Jain Architecture.

Mantrikas Subsequent to 1080 Vikrama era.

WE shall now make a few observations on the lives of the various Māntrikas mentioned above, referring specially to their magical powers and miraculous achievements.

ŚRĪ ABHAYADEVASŪRI

Śrī Abhayadevasūri is the famous Āchārya who has commented on nine out of the eleven Aṅgas—Jain sacred scriptures. His parents were Mahīdhara and Dhanadevī of Dhārā. He was initiated by Śrī Jineśvarasūri already mentioned. Āchāryaship was conferred on him at the age of 16 years about 1088 Vikram era. The nine commentaries on the nine Aṅgas mentioned above were written by him at the instance of Śāsanadevī who as the legend goes made a present of one of her ornaments bedecked with jewels to provide moneys for making the first copies of the nine commentaries. He also wrote a Bhāṣyagloss on his preceptor's work 'Ṣaṣṭhānaka' and Sangrahaṇī on the 3rd Pada of Prajñāpanā and commentaries on Upāṅga Uvavāi and Hari-bhadrāsūri's Pañcāśaka. He also wrote Āgama—Aṣṭottarī and Ārādhana—Kulaka. Śrī Abhayadevasūri's health was greatly impaired by the continuous strain of writing the voluminous commentaries and when he went to Dholkā after completing them he suffered from a skin disease. He was, however, cured of the same by Dharaṇendra. Thereafter being directed by Dharaṇendra, he went guided by a goddess in white to a place on the bank of the river Sedhikā—near modern Cambay and discovered the idol of Sri Pārśvanātha by reciting the Jayatihuṇa hymn composed by him extempore. It is said that the last two verses of the hymn having special magical effect were kept secret at the instance of the presiding deity Dharaṇendra. The idol is known as Śrī Stambhana Pārśvanātha and the place Stambhanapura, (modern Thāmbhaṇā) a village near Cambay. The supervision of the construction of the temple of Śrī Stambhana Pārśvanātha was entrusted to Śrī Āmreśvara, a pupil of Mallavādi of Mehsāṇā, and he was paid one Dramma (a silver coin) per day as remuneration.

neration. This is very significant and shows the depth in the downward tendency to which the Caityavāsis had sunk.

Āmreśvara, however, lived like a true Sādhu obtaining his food by begging and applied his remuneration to the construction of a small temple. Abhayadevasūri died in 1135 Vikrama era at Kapadvanj.

ŚRĪ VĪRĀCĀRYA

Śrī Vīrācārya was a contemporary of King Siddharāj of Gujarāt. In his biography contained in Prabhāvākacaritra details about the place and date of his birth and parentage are not mentioned nor are the dates of his initiation or death given. He was a pupil of Vijayasimhācārya of Śandilla Gaccha. Once Siddharāj out of kingly pride told the Āchārya that his importance was due to the King's friendship. Thereupon the Āchārya informed Siddharāj of his intention to leave his capital immediately. Siddharāj said that he would not allow him to leave his capital. Thereupon the Āchārya flew away by his miraculous power from Pāṭan to Pāli in Mārwar. King Siddharāj coming to know of it sent his ministers to request him to come back to Pāṭan. The Āchārya however did not immediately return but promised to go there in due course. He defeated several noted disputants in religious debates at several places including Gwālior. The King of Gwālior thereupon being pleased with him presented to him the royal paraphernalia. Thence he went to Nagore. Siddharāj again sent his ministers to escort the Āchārya back to Pāṭan and accordingly he returned there. He defeated there a Sāṅkhya disputant named Vādisimha carrying on his debate in verse, employing the metre and figure of speech stipulated by his opponent. It is stated in his biography that he owned a Caitya (temple) and that at Siddharāj's request he recited a benedictory verse on the occasion of Siddharāj's leading an attack on Mālwa. As Siddharāj succeeded in his said expedition, on his return he hoisted a flag on Vīrācārya's temple. Thence started the practice of hoisting flags on Vīrācārya's temple whenever important missions were undertaken. Some remnants of Caityavāsi practices can be noticed in Vīrācārya's life. It shows

that the influence of Caityavāsis persisted for a considerable time after 1080 Vikrama era.

Vīrācārya was endowed with such miraculous power through worship of Sarasvatī, the goddess of learning, that he once made even a girl of five years successfully carry on a learned debate with a Digambara dialectician named Kamalakīrti on the subject whether women can attain salvation.

ŚRĪ JINADATTASŪRI

Śrī Jinadattāsūri was born in s. y. 1132 of Vacchiga father and Bāhadadevī mother of Humbada caste at Dhavalak (modern Dholkā). He was initiated in s. y. 1141 by Śrī Dharmadeva a pupil of Śrī Jineśvarasūri. He was ordained Āchārya and was declared successor to Śrī Jinavallabhasūri (who had died in s. y. 1167) by Śrī Devabhadrācārya (a pupil of the famous Navāṅgavṛttikāra Śrī Abhaya-devasūri) in s. y. 1169 and received the name, 'Śrī Jinadattasūri.' He was thus a contemporary of the famous Vādi Devasūri and Kalikāla-sarvajña Hemacāndrācārya. He was a great Māntrika and was successful in securing control through Sādhanā over the famous 52 Vīras (Powerful male Māntric deities) and 64 Yoginis. (Powerful female Māntric deities) as also 5 Pīras * presiding over and having their abode at the confluence of the five rivers named Pañjnad with the Indus in the Panjāb. At Ajmer he secured control over the deity presiding over lightning and obtained a boon. He made thousands of people of all castes including several princes embrace Jainism by his preachings and miraculous powers. He warded off an epidemic at Vikramapura, modern Bikāner, and thousands embraced Jainism as a result. It is said that a Jain layman named Nāgadeva worshipped Śrī Ambikā to find out who was the 'Yugapradhāna', the leader of the age, and Śrī Ambikā wrote a verse in his palm and said that he who would read the verse was the Yuga-pradhāna. Nāgadeva went round showing his palm and ultimately came

* See p. 243 post for Sādhanā of 5 Pīras.

to Śrī Jinadattasūri who put Vāsa (fragrant powder made of Sandal-wood saffron etc.) on his palm and asked his pupil to read it and to the surprise of the hearers he read the verse which mentioned the name of Śrī Jinadattasūri as Yugapradhāna.+ The verse ran as follows :

दासानुदासा इव सर्वं देवा यदीयपादाब्जतले लुठंति ।

महस्थलीकल्पतरुः स जीयाद् युगप्रधानो जिनदत्तसूरिः ॥

His favourite Mantra was 'Om Hrīm Namah' which he recited crores of times. Śrī Jinaprabhasūri describes it in his Padmāvati Catuspadikā and attributes it to Śrī Jinadattasūri (See Appendix 10 vv. 16-18). Śrī Pūrṇa Kalaśagaṇi, in his commentary on v. 1 of his Māntric hymn of Śrī Śtambhana Pārśvanātha (p. 50 Jain Stotra-Sandoha Vol. II), cites two verses describing the said Mantra and attributes the same to Śrī Jinadattasūri.* The said verses are really taken from Śrī Bhairava Padmāvati Kalpa, Ch. III, and are verses 33 and 34 there. They describe the Ekākṣarī Mantra of Śrī Padmāvati. As Śrī Jinadattasūri was probably the first Āchārya to propound the said Mantra amongst Svetambara Jains, it is attributed to him. The worship of Śrī Padmāvati appears to have become more popular amongst Svetambara Jains about his time.× Śrī Jinadattasūri and Śrī Jinakuśalasūri and Śrī Jinacandrasūri, whose achievements are recorded below, are said to respond to devotional Māntric invocation even after their death. They are known under the honorific title 'Dādāji' or grandfather as they promptly fulfil the desires of their devotees and protect them as a grandfather would protect his grand-children. They can, therefore, be said to be Māntrikas par-excellence. They are worshipped and invoked

+ This title is mentioned Kharatara in the colophon of the palm-leaf Ms. of Pattāvali by Jinacandra written in 1171 Vikrama era. See Catalogue of Jesalmere p. 17 under No. 150.

* For an explanation of the discrepancy see p. 229 post.

× See Supāsanāhacariyam (s.y.1199) p. 131, verse 54 for a reference to Śrī Padmāvati as a very famous Vidyā:

“अस्थि सुपसिद्धविज्ञा विज्ञासाहगसहस्सनयचलणा ।

मंतसरोरुहसरसी देवी पद्मावती नाम ॥”

like Śrī Gautamaswāmi and Śrī Vajraswāmi. They were all ideal Gurus and it is through such Gurus that Gurupūjā on which special stress is laid in Mantraśāstra can be justified.

Śrī Jinadattasūri was also a scholar and composed Gaṇadhara-sārdhaśataka, Gaṇadhara-saptati, Sandehadolāvali, Carcarī Prakaraṇa, Kālasvarūpa Dvātrimśikā, Upadeśarasāyana, Prabodhodaya, Pada-sthāpanāvidhi, Pattāvali and several Kulakas and Stotras. He died at Ajmer on Thursday, on Āṣāḍha Sud 11th, 1211 Vikrama era. A shrine was constructed in his memory on Viśalapur lake and his footprints were installed therein. The said shrine still exists and the place where it is situate is known as Dādāwadi. The footprints of Śrī Jinakuśalasūri mentioned below, are also installed there.

VĀDI DEVASŪRI

Vādi Devasūri was a contemporary of the famous Māntrikas Śrī Jinadattasūri, Śrī Hemacandrāchārya and Śrī Malayagiri. He is famous for his historic debate with Digambara Śrī Kumudacandra, which took place in 1181 Vikrama era at Pāṭan in the Court of Siddharāj Jayasing King of Gujarāt, in which he successfully established that women can attain salvation. The debate between them was as representatives of the two main factions of the Jains, Śrī Devasūri representing the Svetambaras and Śrī Kumudacandra the Digambaras. The condition of the debate was that whosoever was defeated therein should leave the province of Gujarāt with his followers. Śrī Devasūri succeeded in the debate and Śrī Kumudcandra had to leave Gujarāt with his followers.

Siddharāj offered one lac gold mohurs to Śrī Devasūri on his succeeding in the said memorable debate which was however refused by him in conformity with the rules of conduct for Sādhus. The said sum was thereupon spent by Siddharāj in the construction of a temple wherein quddruple idols of Śrī Ṛṣabhdeva were got installed by four Āchāryas in 1183 Vikrama era.

Śrī Devasūri was born in a Prāgvāṭ family of Devanāga and Jinadevī parents in Madāhṛta in Gujarāt (Modern Maduā near Mt.

Abu) in 1143 and was initiated by Śrī Municandrasūri in 1152 and was ordained an Āchārya in 1174 Vikrama era. He wrote Pramāṇa-naya-tattvāloka containing 374 aphorisms on Jain logic and an encyclopaedic commentary thereon named Syādvāda-Ratnākara said to be of the size of about 84000 verses of which a portion of about 20000 verses in size is still available. The said work is a standard work on Jain logic and is a testimony to the great acumen and the vast knowledge of the various systems of philosophy of its learned author.

There is a curious magical bout recorded to have taken place at Broach between Śrī Devasūri and a Yogi named Kānhado who had with him different kinds of snakes with deadly poison. The Yogi prompted them to bite Śrī Devasūri and the latter drew three lines around him which they would not cross. On that the Yogi let loose a pair of snakes one riding the other. They approached the magical boundary and one of them, the rider, rubbed it off with its tongue and they were about to proceed onwards when the goddess Kurukullā, who was pleased with Śrī Devasūri, in the form of a kite picked off both the snakes. Thus ended the bout in which Śrī Devasūri triumphed over the Yogi. There is a Māntric hymn of Śrī Kurukullādevī composed by Śrī Devasūri still available which is believed to be of such miraculous efficacy that those who recite the same are said to be safe from the danger of snake-bites (See p. 230 Jain Stotra-Samuccaya). Both Śrī Devasūri and his preceptor Śrī Municandrasūri have composed Māntric hymns of Śrī Kalikuṇḍa-Pārśvanātha (See p.118-120 Jain-Stotra-Sandoha).

It would appear that Śrī Devasūri having been a grand pupil of Gandharva * Vādivetāla Śrī Śāntisūri must have inherited from him the

* It appears from the biography of Śrī Śāntisūri that a serpent goddess (Naginī-devī) used to attend his preachings. It shows his connection with serpent deities and elucidates his title of Gandharva. Śrī Devasūri cured minister Ambāprasāda who was bitten by a snake while going up Mt. Abu. Reaching the top thereof, he made obei-

Mantras and Vidyās which ensured protection to the Sādhaka against snakes and success in debates. As Śāntisūri had achieved extraordinary success in the Sādhanā of Sarasvatī his grand-pupil also must have been similarly successful. His other Māntric achievements in removing the troubles created by the said Kumudacandra are described in his biography in Prabhāvakacaritra and elsewhere and we need not narrate them here. He performed installation ceremonies in new temples constructed at Falodhi and Ārāsaṇa (modern Kumbhāriā near Mt. Abu) in 1204 and died in 1226 Vikrama era.

ŚRĪ HEMACANDRĀCĀRYA
ŚRĪ MALAYAGIRI AND ŚRĪ DEVACANDRASŪRI

Tradition says that Śrī Devacandrasūri Śrī Hemacandrācārya and Āchārya Śrī Malayagiri jointly performed the Sādhanā of Siddhacakra and obtained boons from the presiding deity. Śrī Hemacandrācārya was granted the boon which endowed him with powers to convince king of the truth of the Jain doctrine and to make him accept the Jain faith, Śrī Malayagiri obtained the boon enabling him to comment on the Jain canon and Śrī Devacandrasūri, by the boon, secured to himself power by which Vira-deities may be at his command so that he might get them transfer temples idols and things from distant places whenever he desired. Now Devendrasūri, the Āchārya who actually installed in a temple at Serisā idols brought there in a single night from Ayodhyā to Serisā was of Nāgendragaccha and flourished later (Circa 1264 Vikrama era). He could not, therefore, be one of the three Āchāryas concerned in the aforesaid Sādhanā. This anachronism can be explained by the supposition that the Āchārya concerned was Devacandrasūri, the preceptor of Sri Hemacandrācārya and not the said Devendrasūri. He might have been the recipient of the said boon. He was actually

sance to Śrī Rṣabhadeva and then before Śrī Ambikādevī he recited a hymn in her praise on which she appeared before him and advised him to return immediately to Pātan as his preceptor was destined to die there after eight months from that day. Śrī Śāntisūri is also credited with the restoration of Aṅgavidyā.

credited with powers to turn base metals into gold. It is a well known fact that Śrī Hemacandrācārya made king Kumārapāla accept the Jain faith and the latter issued proclamations prohibiting killing of living beings for any purpose whatsoever. Śrī Hemacandrācārya wrote Yogaśāstra which describes four kinds of Dhyāna viz. Piṇḍastha, Padastha, Rūpastha and Rūpātīta and while describing Padastha Dhyāna sets forth several Mantras meant for obtaining salvation as well as other worldly objects. * He was an encyclopaedic writer of very versatile intellect and wrote standard works on every branch of literature which need not be recounted here. His works include Sanskr̥ta and Prākṛta grammar, lexicon, logic, metrics, poetics, poetry, biographies and history.

In more senses than one he was an epoch-making Āchārya and a great scholar. Not only was he a Jain scholar but also the foremost savant of his times and the foremost savant of Gujarāt for ages to come. He has, therefore, rightly received the title of 'The omniscient of the Kali Age.'

We have already referred to his having received a boon from Sarasvatī and his works bear ample testimony to his having been a divinely gifted scholar and a genius. The hymn to Sarasvatī contained in Appendix No. 13 hereto is really his composition and is wrongly attributed to an unknown Śivāryā only through misapprehension. It seems practical Yoga had acquired much popularity by his times, and that explains his dilating on Haṭha Yoga practices in his Yogaśāstra. He was born at Dhandhukā in a Modha Baniā family of Cacca and Cāhiṇi parents on Kārtika Śukla 15th, 1145, Vikrama era. He was initiated by Śrī Devacandrasūri in 1154 and was ordained Āchārya in 1162 at Nāgore in Mārwar. He was present in the Court of Siddharāj with Śrī Devasūri in 1181 Vikrama

* He has composed 'Arhannāmasahasrasamuccaya', a hymn containing a thousand names of Śrī Arhan-Tīrthaṅkara, which is one of the five parts (Pancāṅga) of Māntric worship. It is published in Jain-Stotra-Sandoha, Pt. 1, pp. 1-13. Amongst these names the following as epithets of Tīrthaṅkara are significant: मन्त्रविन् मन्त्रकृत् मन्त्री मन्त्रमूर्तिरनन्तरः, महामन्त्रो महातन्त्र इत्यादि।"

era at the time of his said memorable debate. He was on the best of terms with King Siddharāj and composed his famous Sanskṛta and Prākṛta grammar Siddhahema at his instance. He was a 'Guru' of King Kumārapāl in every sense of the term.

Śrī Hemacandrācārya cured minister Ambada (the second son of Minister Udayana) who was seriously affected in health under the malefic influence of Yoginīs at Broach when engaged at the instance of Śrī Hemacandrācārya in carrying out the repairs of the old wooden temple of Śrī Munisuvṛataswāmi. It is narrated in his biography how Śrī Hemacandrācārya accompanied by his pupil Śrī Yaśascandragani went to the temple of Śrī Saindhavadevī outside the fort of Broach making offerings (Bali) at various stages and ultimately persuaded Śrī Saindhavadevī to order the Yoginīs leave off afflicting the minister Ambada. This incident illustrates the Māntric accomplishments of the great Āchārya. *

Further when King Kumārapāla was threatened with an invasion by the King of Kalyāṇakaṭaka Śrī Hemacandrācārya recited Sūrimantra and was informed that the said King would die on the 7th day on the way and his army would withdraw. As a result of Śrī Hemacandrācārya's preachings King Siddharāj built two temples 'Rāyavihāra' and 'Siddhavihāra' and King Kumārapāla built 'Kumāra Vihāra', 'Tribhuvana Vihāra', 'Trivihāra' and several other temples.

Āchārya Malayagiri is an exceptionally lucid commentator of great acumen and independence of thought. His life very probably extended from about 1150 to 1220 Vikrama era. In his commentary on Śrī Āvaśyakasūtra at p. 11 he cites the 30th verse of Hemacandrācārya's Anyayoga-vyavaccheda Dvātriṃśikā and there mentions him by the respectable title of 'Guru'. It is therefore possible that Śrī Hemacandrācārya may have been at least his Vidyāguru.

* He was respected by all Pīṭhas (deities thereof) Jālandhara and others—See Prabhāvaka-caritra P. 341 v. 748 of his biography.

ŚRĪ PĀRŚVADEVAGAṆI ALIAS ŚRĪ CANDRASŪRI

Śrī Pārśvadevagaṇi received the name of Candrasūri when he became Āchārya. He was a pupil of Śrī Dhaneśvarasūri of Candrakula. There are several commentaries written by him on some of the sacred scriptures of the Jains especially on the five Upāṅgas going under the name of Nirayāvalis. He also composed 'Sukhabodhā Sāmācārī,' a work on rituals for Sādhus as also laymen which includes a chapter on installation ceremonies. The Upāṅga commentaries and 'Sukhabodhā Sāmācārī' are composed by him under the name 'Candrasūri'. There is a Panjikā commentary written by him in 1169 Vikrama era under the name of Pārśvadevagaṇi on Śrī Haribhadrasūri's commentary on the manual of Buddhist logic 'Nyāya-Praveśa' by the famous Buddhist Ācārya Diñnāga. Among his Māntric writings are his commentaries on Śrī Bhadrabāhu's hymn 'Uvasaggaharam' and the hymn 'Śrī Padmāvatyāṣṭaka.' He shows therein intimate knowledge of Mantra-śāstra.* He flourished from about 1150 to 1228 Vikrama era.

ŚRĪ SĀGARACANDRASŪRI (Circa 1246 Vikrama era)

Śrī Sāgaracandrasūri is the author of Śrī Mantrādhirāja Kalpa, a work in five Paṭalas (chapters) on the famous Mantrādhirāja of Śrī Pārśvanātha, as propounded by Kamaṭha, giving details of worship of Śrī Pārśvanātha, diagram, Dhyānas of Vidyādevīs Sāsanayakṣas. Sāsanayakṣinīs and Śāṭkarma and several other Mantras incidentally. + The author states in the colophon that the said work was one of the nine Kalpas relating to Pratyāṅgirā and others. The said statement is sufficient to establish the Māntric character of the author. He has also stated in the fourth Paṭala that he is giving details from various old Kalpas.

* At one place he refers to Śrī Candrasena Kṣamāśramaṇa as an old and recognised authority. The title of Kṣamāśramaṇa shows that he must have flourished when Pūrva literature was not entirely lost.

+ He gives the following Mantra of Śrī Pādmāvati, p. 264 Mantrādhirāja Cintāmani:
ॐ ऐं ह्रीं ह्रस्वीं ह्रस्वीं ह्रस्वीं देवी पद्मावती नमः ॥

As there have been several persons bearing identical names it is difficult to state with certainty who amongst them was the author of the said work. From the references however in the said work to Śrīprabha, Nemiprabha, Lalitaprabha, Śrī Padmadeva and others we think that he probably belonged to Rājagaccha and was the pupil of Śrī Nemicandra. His pupil Maṇikyacandrasūri wrote in 1246 Vikrama era the commentary named Saṅketa on Kāvyaṅprakāśa of Mammaṭācārya and Pārśvacaritra (1276 Vikrama era) and also Śāntināthacarita.

ŚRĪ AMARACANDRASŪRI

Śrī Amaraçandrasūri, author of Bālabhārata Mahākāvya ranks among the great classical Sanskṛta poets and his fame is not restricted merely to the Jain world but has spread far and wide amongst all Sanskṛta-knowing people. He was a contemporary of ministers Vastupāla and Tejapāla and flourished in the 13th century of the Vikrama era. He is known as a Siddha-Sārasvata Kavi i. e. one who has been fortunate in securing the favour of the goddess of learning Sarasvatī by her Māntric worship. His life is described in Śrī Rajaśekharaçūri's Prabandha Koṣa from which an extract is also given in the introduction to his poem Bālabhārata published by Nirṇayaçāgara Press. It is stated in his said biography that he obtained a Mantra for worship of Sarasvatī from Kavirāja Amaraçimha, * a devotee of his preceptor Śrī Jinadattaçūri of Vāyadagaccha, and successfully performed the Sādhanā of Sarasvatī, for twenty one days accompanied by necessary Homa. At the end of the said Sādhanā Sarasvatī appeared before him, in her divine form, at midnight from the disc of the moon that had risen in the sky, gave him nectar from her own bowl to drink and gave him the boon that he might be an accomplished poet honoured

* He was a protegee of Vastupāla and wrote Sukṛta Saṅkīrtana praising the good deeds of the minister Vastupāla. At the end of each of its 11 cantos five verses are by Śrī Amaraçandrasūri in course of which he praises the poetic powers of Amaraçimha and calls him the full-moon of the great ocean of nectar of Sarasvatī. This shows the great regard he had for Amaraçimha.

by all the kings. His preceptor Śrī Jinadattasūri was accomplished in Yoga and knew the art of animating the dead body of any creature by transferring his soul to the same. He belonged to the line started by Śrī Jinadevasūri whose life and miraculous achievements are described in Prabhāvākacaritra.

As in his poem Bālabhārata he introduced an original comparison comparing the Veṇī (a braid of hair) with Kṛpāṇa (Sword) he became known in the poetic world as 'Venikṛpaṇo-marāh.' Here is the said verse:—

‘दधिमयनविलोललोल दृग्वेणिदम्भा—

दयमदयमनङ्गो विश्वविश्वैकजेता ।

भवपरिभवकोपत्यक्तबाणः कृपाण—

भ्रममिव दिवसादौ व्यक्तशक्तिर्व्यनक्ति ॥’ (आदिपर्व-स० ११ श्लो० ६)

Viśaladeva King of Gujarāt having heard of him as a great poet sent his minister Vaijala to invite and escort him to his capital Dholkā.

Thereupon Śrī Amaraçandra went to his Court. Here various poets at the instance of the King proposed to him 108 samasyās—parts of stanzas for appropriate completion by him which he did immediately to the satisfaction and delight of all. The Court and the King were so much engrossed in this pastime that they sat there without rising for meals till the evening, which shows Amaraçandrasūri’s powers to keep his hearers delighted and spell-bound. The King thereupon remarked that Amara was really the universal monarch of poets. * We would cite here only one Samasyā proposed by the poet Nānāka for completion by Śrī Amaraçandrasūri. It is ‘गीतं न गायतितरां युवतिर्निशासु।’ which was completed thus:

‘श्रुत्वा ध्वनेर्मधुरतां सहसावतीर्णे भूमौ मृगे विगतलाञ्छन एष चन्द्रः।

मागान्मयीयवदनस्य तुलामितीव गीतं न गायतितरां युवतिर्निशासु ॥’

Besides Bālabhārata he composed ‘Padmānanda Mahākāvya’ Kavi-kalpalatā with Kaviśikṣā commentary, Chandoratnāvali, and Syādisamuccaya. His Sūktāvali, Kalā—Kalāpa, Alankāraprabodha and Kāvya-kalpalatāparimala with Mañjari commentary are not yet found.

* ‘सस्यं कविसार्वभौमः श्रीअमरः।’

ŚRĪ BĀLACANDRASŪRI

Srī Bālacandrasūri was born at Modherā in Kadi of Brāhmaṇa parents Dharādeva and Vidyut. He was named Munjāla. He was initiated by Srī Haribhadrasūri. The best part of his life was spent in the later half of the 13th century of the Vikrama era. Padmāditya the famous Rājaguru of Chaulukyās was his teacher. He obtained Sārasvata-Mantra from Udayasūri, an Āchārya in the line of the famous Vadi-devasūri. He wrote the famous Mahākāvya Vasantavilāsa in the beginning of which he himself mentions his having worshipped Sarasvatī and having obtained a boon from her to be a Mahākavi—great poet like Kālidāsa. He also describes himself as the adopted son of Sarasvatī (Vāgdevīpratipannasūnu). He was thus a Mantrasiddha. He must have written some works on Mantras as would appear from his short Pratyāṅgirā-Kalpa in the form of a hymn. The writer has in his possession the said Pratyāṅgirā Stotra of 25 verses. We give below the opening verse, and also the last verse as it mentions the name of the author.

स्तोत्रं गोत्रभिदादिकैरपिसुरैर्माहात्म्यतादात्म्यतः।
 शक्यं नैव निजावबोधसहितं कर्तुं भवत्पादयोः॥
 तस्मात्त्वद्वदनोद्गतागमगणव्यारव्यानमारब्धास्यतः।
 तन्मे नास्ति मनुष्यमात्रवपुषो प्रत्यंगिरे दूषणम्॥ १॥

श्रीमान् बालकविः कृती त्रिभुवने चंद्रः कलासंपदाम्।
 विख्यातो रचयांचकार यदिदं दिव्यागमोक्तक्रमात्॥
 स्तोत्रं तत्पठतां विनम्रमनसां प्रत्यंगिरा प्रत्यहम्।
 संतुष्टाखिलसंपदः प्रकुरुते सर्वाश्च हृत्यापदः॥ २५॥'

From the reference in the last verse to Divyāgamā one might surmise that he was a student of the Divyamārga of the Śāktas and their Āgamas. He also wrote a drama named Karuṇā-Vajrāyudha and commentaries on the two noted works of his contemporary Āsada named Vivekamanjarī and Upadeśakandalī. He has been praised by Śrī Pradyumnasūri in his 'Samarādityasamkṣepa' as the author of many Prabandhas.

He was praised also by the minister Vastupāla for his high poetic merit.*

SRI DHARMAGHOṢASŪRI

Srī Dharmaghoṣasūri was a pupil of the famous Devendrasūri* of Tapāgaccha and became the 46th pontiff. He was born at Ujjain of a merchant Jinabhadra about the end of the 13th century of the Vikram era. His name was Bhīmasiṃha. His elder brother was named Vīradhavalā. As a result of Srī Devendrasūri's preachings, when Vīradhavalā was about to marry, he renounced the world and was initiated in 1302 Vikrama era. Sometime thereafter his younger brother Bhīmasiṃha was also initiated. The former was given the name of Vidyānanda and the latter Dharmakīrti. In 1323 the former was ordained Āchārya and the latter Upādhyāya. Both Srī Devendrasūri and Srī Vidyānanda died in 1327 at an interval of 13 days and thereafter in 1328 Dharmakīrti was ordained Āchārya and named Srī Dharmaghoṣasūri. He was a great Māntrika and possessed prophetic powers of divining future. Minister Pṛthvīdhara alias Pethad, when in ordinary circumstances approached him to take a vow not to retain in his possession or enjoyment properties aggregating in worth over one lac rupees. Srī Dharmaghoṣasūri having known by his prophetic powers that he would attain great prosperity and become extremely wealthy in future asked him not to take such a vow. Ultimately Pethad became a great man and a minister of the King of Māndavagadha and acquired much wealth, a large portion of which he spent in building 84 temples and constructing seven Bhandāras or libraries for keeping manuscripts of Jain religious and secular literature. He also celebrated the entry of Srī Dharmaghoṣasūri.

* 'बहुप्रबन्धकर्तुः श्रीबालचन्द्रस्य का स्तुतिः ।

मन्त्रीशिवस्तुपालेन यः स्तुतः कवितागुणात् ॥' प्रद्युम्नसूरिकृतसमरादित्यसंक्षेपात् ।

* He is famous as the author of five new Karmagranthas—works on Karma philosophy with commentaries, three Bhāṣyas, Vandāruvṛtti, Sādhusāmācārī, Śrāddhadinakṛtya with a commentary, commentary on Dharmaratnaprakaraṇa, Sudarśanācarita, Siddhapancāśikā with a commentary, Siddhadaṇḍikā several hymns, Kulakas and a Sūrimantra Kalpa.

ghoṣasūri in Māndavagadha spending a very large amount. He had an only son Zāñzaṇa who also was very religious and became famous for his charities.

We shall now shortly describe Śrī Dharmaghoṣasūri's miraculous achievements. In Prabhāsapāṭaṇa by reciting a Māntric hymn he made the rising sea offer jewels to the Jain temple on its shore. There he made the old heretic Kapardi Yakṣa, who appeared before him attracted by his contemplation, accept the Jain faith and undertake the duty of protecting the idol of Śrī Jina. Once he punished the women who sought through charmed food to adversely affect Jain Sādhus but let them off when they begged his pardon and prayed for mercy. He himself was once adversely influenced magically in the midst of his religious discourse at Vijāpur(Gujarāt) by female magicians of a different persuasion who created obstruction in his throat with a view to affect his voice. They were thereupon paralysed and stuck to the ground, where they were seated, by the Āchārya, and were let off only when they promised not to trouble any one of his followers. His most important Māntric bout was with a Yogi at Ujjain who would not allow any Jain Sādhus to remain there in peace for any length of time without creating various troubles for him. As was his wont, he threatened the disciples of Śrī Dharmaghoṣasūri, when once they went to Ujjain along with their preceptor. They did not however pay heed to his threats and only informed their preceptor about them. Very soon the Yogi giving vent to his ire created swarms of ferocious rats in the Upāśraya—the place for stay of the Sādhus. Śrī Dharmaghoṣasūri thereupon recited Mantras over an earthen pot, which was covered up with a piece of cloth, and the Yogi was compelled to come down there crying with excruciating pain. He asked to be forgiven for his malicious misdeeds and was let off on his promising not to trouble any Sādhus in future. Śrī Dharmaghoṣasūri was once bitten by a snake and informed by his prophetic powers the Jain Sangha assembled there that a man with a bundle of furs who would be entering the city-gate at a particular time would have in the bundle a medicinal herb which was an antidote and a positive

cure for snake—bite. It was thereupon procured and Śrī Dharmaghoṣasūri was cured. As a penance for using green herb, even when faced with such situation, against the rules of conduct for Sādhus he gave up all sweets, milk, curds, ghee, oil etc. for the rest of his life and lived only on Juvari—bread.

He composed many hymns some of them being Māntric. He also composed Sanghācāra-vṛtti and Kālasaptatikā, Samavasaraṇa Kāyasthitī and Bhavasthiti Prakaraṇas.

His pupil was Śrī Somaprabhasūri who was so strict in observing the rules of conduct for Sādhus that apprehending possible abuse he did not accept the book of magic which was offered to him by his preceptor Śrī Dharmaghoṣasūri. This throws a considerable light on the high ideals and selfless and pure life led by these Sādhus.

ŚRI DEVABHADRAGANI

There is a Pratyāṅgirākalpa in Prākṛta consisting of 76 verses by Śrī Devabhadragani who describes himself in the last verse thereof as a bee in the feet of Pradyumnasūri and alludes to Devendra and Munīndra. He is not, therefore, the famous Upādhyāya Devabhadragani of Caitravālagaccha the preceptor and co-worker in the Kriyoddhāra (the reinstatement of the original religious practices and observances) of the famous Śrī Jagaccandrasūri who having remained invincible in 32 debates with Digambara dialecticians in the Court of King Jaitrasimha of Āghāṭa (near modern Udaipar) received the title of 'Hīralā' i. e. 'Diamond' meaning of 'adamantine quality' and also the title of 'Tapā' because of the performance of severe austerities and gave that name to his Gaccha, which till then bore the name of Vadagaccha or Bṛhadgaccha, in 1285 of Vikrama era. He must have been a pupil of the famous scholar Śrī Pradyumnasūri * who wrote Samarādityasaṃkṣepa in 1324 Vikrama era.

* He also wrote Pravajyāvidhāna in 1338. He also critically examined and revised works of Udayaprabha, Devendra, Dharmakumāra, Prabhācandra, Bālacandra, Mānataṅga, Munideva, Ratnaprabha, Vinayacandra and others.

The reference to Devendra might be to Devendrasūri (a pupil of Śrī-Candrasūri of Candragaccha) whose Upamitibhava-Prapañca,—Kathā-Sāroddhāra was revised by Śrī Pradyumnasūri and the reference to Munīndra might be to Munideva in the line of Vādi Devasūri who wrote Sāntināthacaritra in 1322 Vikrama era and also a commentary on Dharmopadeśamālā. Both were revised by Śrī Pradyumnasūri. Both flourished circa 1300 Vikrama era. The date of Śrī Devabhadragaṇi author of Pratyāṅgirākālpa would therefore be the same. Worship of Pratyāṅgirā seems to have become popular amongst Jains about this time, as Sāgaracandrasūri already described above also wrote a Pratyāṅgirā Kālpa. There is no wonder that her worship was popular as she is conceived as a deity counter acting the malevolent Kṛtyā as well as all kind of Māntric influence of others from the time of Atharvaveda as her name literally means counter to Aṅgiras i. e. adverse Māntric practices of Atharvaveda. *

ŚRĪ PURṆAKALAŚAGAṆI

Śrī Pūrṇakalaśagaṇi was a pupil of Śrī Jineśvarasūri of Kharataragaccha and flourished circa 1307 Vikrama era. His Māntric hymn 'Śrī Stambhana-Pārśvanātha-Jina Stavana and its commentary establish him not only as a Māntrika but also as one proficient in the use of medicinal herbs. It also appears from some of the Mantras contained in his said commentary that a beginning was already made to assimilate non-Jain Mantras† some of them being on a par with Śābara Mantras. ×

* "The oldest name, however, by which this Veda is known in Indian literature is Atharvāṅgirasah, that is "the Atharvans and the Aṅgiras." The two expressions *atharvan* and *aṅgiras*, however designate two different species of magic formulas; *atharvan* is "holy magic, bringing happiness," while *aṅgiras* means "hostile magic, black magic." Among the Atharvans, for example, are the formula for the healing of diseases, while among the Aṅgiras are the curses against enemies, rivals, evil magicians and such like."

P. 120 History of Indian Literature Vol. 1 by M. Winternitz.

† ॐ उदितो भगवान् सूर्यः पद्माक्षो वृक्षकेतनः

भादित्यस्य प्रसादेन भमुकस्यार्द्धमेटक नाशाय २ स्वाहा ॥गा० १३ टीका

× See commentary on V. 37 of the hymn.

In his commentary on the first verse of the said hymn he quotes verses 33&34 from Ch. III of Śrī Bhairava Padmāvatī-Kalpa wrongly attributing them to Śrī Jinadattasūri. A possible explanation of the mistake is that Śrī Jinadattasūri must have incorporated some portions including the said verses, of Śrī Bhairava Padmāvatī Kalpa in some work of his own, possibly a work on Hrīmkāra or Māyābīja which Mantra is known to be a favourite Mantra of Śrī Jinadattasūri, and since his time of the followers of Kharataragaccha, and then amongst all the Jains. The dates of his birth, initiation etc. and details of his parentage and place of birth are not known. He studied under Śrī Jinaratnācārya. There is no doubt that he was a very learned man as his commentary on Śrī Hemacandrācārya's Prākṛta Dvyāśraya Kāvya composed in 1307 of Vikrama era shows conclusively.

ŚRĪ JINAPRABHASŪRI

The exact years of the birth and the death of Śrī Jinaprabhasūri are not known, but his life most probably extended from about 1320 to 1390 Vikrama era.* It appears from an account contained in a Paṭṭāvali of the 17th century that he was the third or the fifth son of a Bania merchant of Tāmbī Śrimāla Gotra who lived at Zuznu (Vadodrā according to another version) in Vāgada. According to an older account the merchant lived at Sohilavādi or Mohilavādi and his name was Ratnapāla. His wife Khetalladevī gave birth to a son named Subhaṭapāla who was initiated in 1326 or 1336 Vikrama era, by Śrī Jinasimhasūri of Kharatagaccha at the suggestion of Śrī Padmāvatīdevī who promised to be the tutelary deity-Iṣṭadevatā of the suggested pupil.

* In the addendum to Kannānaya-Mahāvīra-Kalpa by Śrī Vidyātilaka (alias Somatilakasūri, a pupil of Śrī Sanghatilakasūri who has described Śrī Jinaprabhasūri as his Vidyāguru although he was a pupil of Śrī Guṇaśekharasūri), Śrī Jinaprabhasūri is described as living and his doings upto 1390 Vikrama era are narrated.

As Ibn Batūtah the famous Moorish traveller, who came to the Court of Mahomed Tughlaq about 1390 Vikrama era does not mention Śrī Jinaprabhasūri, although he describes several prominent persons in the Court, it may be presumed that Śrī Jinaprabhasūri was not living then.

This Subhaṭapāla was given the name of Śrī Jinaprabha on initiation and ultimately became Śrī Jinaprabhasūri. Śrī Jinasiṃhasūri appointed him as his successor at Kidhiwāṇā in 1341. He performed the Sādhanā of Śrī Padmāvatīdevī some time after his initiation, as directed by his Guru, and Śrī Padmāvatī appeared before him and promised to attend whenever invoked. † Once Śrī Jinaprabhasūri inquired of Śrī Padmāvatī the place where he would rise and attain fame and was told that it would be at Delhi. He thereupon went to Delhi and met Sultan Mahomed Tughlaq on or about Poṣa Sud 2nd 1385 and impressed upon him the truth of the Jain doctrine, and its basic principle of Ahimsā. He made the Sultan restore to the Jains the famous idol of Śrī Mahāvīra of Kannāṇaya (modern Kannāṇā which is four miles from Dadri in Jind State. * It is said to be in Vāgada near Āśikā i. e. Hāṅsī) which was temporarily removed to a temple in Malik Tājdin Sarāi in Delhi and subsequently to the temple at Sultan-Sarāi. It was Śrī Jinadevasūri, the learned pupil of Śrī Jinaprabhasūri, who had secured the grant of the Sarāi named after the Sultan for the habitation of the Jains. The Sultan also got a temple and an Upāśraya-monastery built therein at his own expense.

Śrī Jinaprabhasūri obtained through his influence with the Sultan Firmāns for the protection of the sacred shrines (Tīrthas) of Satrunjaya, Girnār and Falodhi. He similarly secured protection of the Jain temples at Devagiri alias Daulatābād built by the minister

+ That Śrī Jinaprabhasūri was constantly helped by Śrī Padmāvatī is a fact mentioned in lyrical poems composed in his praise some of which werewritten when he was actually living. See also V. 5 of his own hymn (p. 129 Appendix to Vidhiprapā):

सिरिसूरिजिणप्पहमसिन्भरे, सुताणिहि मंनिउ विविह परे।

पउमावइ सानिधि सयल जए चिह नंदउ देहिगु संघवए ॥”

See also V. 13 in the colophon of Vidhiprapā p. 120

“जीए पसायाउ नरा सुकईसरसत्थवल्लहा हुंति ।

सा सरसई य पउमावई य मे दिन्नु सुयरिदिम् ॥”

* According to Pt. L. B. Gandhi it is modern Cannanore in the South.

Pethad, Shah Sahajā and Thakkur Through his intercession hundreds of prisoners were released by the Sultan.

Once again about 1388 Vikrama era he was invited by the Sultan and he went from Devagiri to Delhi. The Sultan was much pleased to see him. He received him with great pleasure and kissed his hand. Śrī Jinaprabhasūri thereafter stayed at a sarāi which was built in 1389 by the Sultan near his palace. It was named after him as Bhaṭṭāarakasarāi.

Once the Sultan started for Gujarāt and camped under a large shady Banyan tree in the first stage of the march. The Sultan liked the tree very much. Śrī Jinaprabhasūri thereupon asked him whether he would like the tree to move along with him. The Sultan replied that he would be pleased if it did so. Śrī Jinaprabhasūri thereupon made the tree move along with them for a considerable distance shading them from the heat of the sun. Then the Sultan requested the Āchārya to send the tree back which he did.

He was wonderfully accurate in his prophecies, and consequently the Sultan was much pleased with him. *

Once the Sultan heard from Śrī Jinaprabhasūri the miraculous qualities of 'Vijaya Yantra'. It was thereupon got prepared under the direction of Śrī Jinaprabhasūri. It was found that the person or animal under the protection of 'Vijaya Yantra' was immune from every sort of harm or injury.

* Śrī Jinaprabhasūri in his Siddhāntāgamastava (Kāvya-mālā, Pt. VII, p. 94) says:

“यस्या भवन्त्यवितथा अद्याप्येकोनषोडशादेशाः ।

सा भगवती प्रसीदतु ममाङ्गवियानवद्यविधिसाध्या ॥४१॥”

and at p. 119, Vidhiprapā in Aṅgavijjāsiddhivihi he describes the rites incidental to the Sādhanā of Aṅgavijjā as taught by Saiddhāntika Śrī Vinayacandrasūri and says:

“विहिणा पुण आराहिय एयं सिज्जंत अवितहाएसो ।

छउमत्थो वि हु जायइ भुवणेषु जिणप्पमायरिओ ॥”

This shows his great faith in Aṅgavidyā for accurate predictions. Probably he himself might have employed Aṅgavidyā for the purpose.

These were times when persons reputed to possess miraculous powers used to be welcome at the Royal Court. They used to vie with each other to establish their superiority and to belittle their opponents. There was one Rāghavacaitanya⁺ proficient in Mantras who became a favourite of the Sultan. He once thought of driving away Srī Jinaprabhasūrī. He, therefore, by his magical powers removed the ring from the finger of the Sultan and clandestinely introduced the same in the Rajoharaṇa (sweeping brush) of the Āchārya. Srī Jinaprabhasūrī was immediately informed of this by Srī Padmāvati and he thereupon introduced the said ring unnoticed in the head-dress of Rāghavacaitanya himself. When the Sultan missed his ring, Rāghavacaitanya accused Srī Jinaprabhasūrī who told the Sultan that the ring was in the head-dress of Rāghavacaitanya and it was found there on the head-dress being searched. Thus worsted in his own art Rāghavacaitanya left the court crest-fallen.

Once a Qalandar (Muslim Darvish) came to the royal court and offered to show miracles. He threw up his Kulah (cap) and it remained hanging in the air without any support. He challenged any one to bring it down. When no one else came forward and the Sultan turned his eyes towards Srī Jinaprabhasūrī he brought it down with his Rajoharaṇa. Then the Darvish kept earthen water-pots which were being carried by a woman, hanging in the air. The Āchārya asked him to keep the water therein so hanging without the earthen pots to support it. He was unable to do so. The Āchārya thereupon got the earthen-pots which were hanging in the air broken up. But the water therein still remained in the air without support. The Āchārya thus triumphed over the Qalandar.

Amongst the Muslim Darvishes of the time was the famous Nasir-ud-din Mahomed, Chiragh-e-Delhi, he having succeeded in 1325 A.D. the famous Nizam-ud-din Awliyā as his Khalīfa. It is possible that

⁺ See his Jwālāmukhīdevī Stotra (Prācīna Lekhamāla, Vol. II, Lekha 100), and MahāGaṇapatistotra (Kāvya-mālā Pt. I, p. 1).

the relations between the said Nizam-ud-din and Ghiyāsuddin Tughlaq having been strained Nasir-ud-din might not have been on the best of terms with Sultan Mahomed Tughlaq especially because the latter was not interested in the propagation of the Islāmic religion.† This fact as well as the influence exercised by the Jains over him are borne out by the following extract from an article by Dr. A. B. M. Habibullah published in the issue of the 'Sunday Standard' dated 18th August 1940 A. D.

"Not interested in the propagation of the Islāmic religion, his belief in which was known to be shaky, he specially favoured the Hindu on a number of occasions. And a writer evidently belonging to the opposition, bitterly laments that the Sultan destroyed the best Mussalmans in India and replaced them by the 'infidels' whom he consistently patronised. Contemporary writers accuse him of not only inclining towards atheism but also to excessive intercourse with Hindu jogis and Brahmans; while evidence has come down to us, in the form of a Jaina Manuscript, of his active patronage extended to a distinguished Jain scholar named Simhakirti. * "

Srī Jinaprabhasūrī at the request of Sultan Mahomed also cured Sultānā Bālāde who was possessed by an evil spirit invoking Kṣetrapāla Meghanāda for the purpose. He also secured control over sixty four Yoginīs † (powerful female spirits) and obtained a boon from them that

† According to Firishta Mahomed Tughlaq desired that Shaikh Nasir-ud-din Chiragh-e-Delhi should attend upon him for personal service viz. dressing him, and imprisoned him on his refusal to do so and released him only when he agreed to perform the said service.

* Perhaps Śrī Jinasiṃhasūrī is meant by this name. He was the preceptor of Śrī Jinaprabhasūrī who acquired considerable influence over Sultan Mahomed Tughlaq. The mistake might be due to the mistranslation of the Sanskrit manuscript due to which preceptor's name is given and the pupil's name is omitted. Epigraphia Carnatica Vol. 88, pp. 377-78, inscription No. 46 however mentions Bhaṭṭāraka Siṃhakīrti who was connected with Sultan Mahomed of Delhi.

+ The following are the names of sixty four yoginīs given by Śrī Jinaprabhasūrī in his famous Vidhiprapā (composed in S. Y. 1363) a work on rituals for laymen and monks at pp. 116-117:—

they would not trouble Āchāryas in his line when they visited any of the four towns famous for the Pīṭhas (abodes) of the sixty four Yoginīs, viz. Delhi (formerly known as Yoginīpura), Ajmer, Ujjain and Broach. Śrī Jinaprabhasūri had acquired such influence over Sultan Mahomed that the latter went with him to the famous Satrunjaya temples at Pālitānā and also to Gīrnār. On the Sultan performing at Satrunjaya, at the instance of Śrī Jinaprabhasūri acts of devotion appropriate to a leader of Jain Sangha the Āchārya made famous Rāyaṇa tree (Piyāla tree) rain milk over the Sultan.

He preached the Jain doctrine to the Khandelvāls of the Jungle country i. e. Rajputānā and in consequence they embraced the Jain faith and gave up the trade of distilling alcoholic liquor from molasses on which they were engaged. He got repairs to the famous Jain Stupa

“बाराही १ वामनी २ गरुडी ३ इन्द्राणी ४ आग्नेयी ५ याम्या ६ नैऋती ७ वारुणी ८ वायव्या ९ सौम्या १० ईशानी ११ ब्राह्मी १२ वैष्णवी १३ माहेश्वरी १४ विनायकी १५ शिवा १६ शिवदूती १७ चामुंडा १८ जया १९ विजया २० अजिता २१ अपराजिता २२ हरसिद्धि २३ कालिका २४ चंडा २५ सुचंडा २६ कनकनंदा २७ सुनंदा २८ उमा २९ घंटा ३० सुघंटा ३१ मांसप्रिया ३२ आशापुरा ३३ लोहिता ३४ अंबा ३५ अस्थिभक्षी ३६ नारायणी ३७ नारसिंही ३८ कौमारी ३९ वामरता ४० अंगा ४१ वंगा ४२ दीर्घदंष्ट्रा ४३ महादंष्ट्रा ४४ प्रभा ४५ सुप्रभा ४६ लंबा ४७ लंबोष्ठी ४८ भद्रा ४९ सुभद्रा ५० काली ५१ रौद्रो ५२ रौद्रमुखी ५३ कराली ५४ विकराली ५५ साक्षी ५६ विकटाक्षी ५७ तारा ५८ सुतारा ५९ रजनीकरा ६० रंजनी ६१ श्वेता ६२ भद्रकाली ६३ क्षमाकरी ६४ ।

चतुःषष्टिः समाख्याता योगिन्यः कामरूपिकाः ।

पूजिताः प्रतिपूज्यन्ते भवेयुर्वरदाः सदा ॥

अमुं श्लोकं पठित्वा योगिनीभिरधिष्ठिते क्षेत्रे पट्टकादिषु नामानि टिक्कानि वा विन्यस्य नामोच्चारणपूर्वं गन्धशैः पूजयित्वा नन्दिप्रतिष्ठादिकार्याण्याचार्यः कुर्यात् ॥ चउसष्टिजोगिणीउवसमप्यारो ३०”

They are differently given in Ācāradīnakara at pp. 207–208 and another set of names is found in Māntric literature (See Appendix No. 24). Tantrasāra gives Sādhana of Yoginīs.

Vācanācārya Śrī Cāritravardhana, the famous commentator of Raghuvamśa and Naiṣadha, who was known as male embodiment of Sarasvatī (Naraveṣa-Vāṇi) and was a spiritual descendant of Śrī Jinaprabhasūri praised him thus :

तत्पट्टपूर्वाद्रिसहस्ररश्मिजिनप्रभः सूरिपुरन्दरोऽभूत् ।

वाग्देवताया रसनां यदीयामाच्छादपटं जगदुर्बुधेन्द्राः ॥”

(tope) of Mathurā executed through his preaching. Amongst his contemporaries were Śrī Somaprabhasūri and Somatilakasūri. Śrī Jinaprabhasūri met the latter at Pāṭan. Their relations were very friendly. Śrī Jinaprabhasūri composed and presented to Śrī Somatilakasūri hymns for the instruction of his pupils. Out of these about 75 available hymns show the great poetic powers of Śrī Jinaprabhasūri. Some of them are Māntric and establish his Māntric proficiency. Amongst them are two hymns of Sarasvatī, a Catuṣpadikā of Śrī Padmāvatī and a hymn of Vardhamānavidyā. He studied and acquired great mastery over the Persian language. He has composed a hymn of Śrī Rṣabhadeva and a hymn of Śrī Śāntinātha in Persian which shows how much he was in advance of his times. Vidhiprapā we have already mentioned. His Tīrthakalpa alias Kalpapradīpa is a work of great historic value. It contains kalpas (treatises) of several Tīrthas or sacred places and also of deities devoted to the Jain faith like Kapardi Yakṣa, Ambikādevī Kohaṇḍiyadevī i. e., Kuṣmāṇḍidevī another name of Ambikādevī, and Padmāvatīdevī. One of the Kalpas relates to Śrī Śatruñjaya and is named Rājaprasāda by him as on its commencement the Sultan was pleased with the Jain Sangha. It therefore establishes Śrī Jinaprabhasūri's connection with the Sultan by his own account. He composed Sūri-mantrāmnāya in 1381 Vikrama era, and also wrote a Māyabījakalpa, a Māntric work on Hrīmbīja. He wrote several commentaries like Kātantravibhramatikā, Kalpasūtravṛtti named Sandehaviṣauṣadhi, Ajita-śantistavavṛtti, Upasargaharastotravṛtti, Bhayaharastotravṛtti and a commentary on Śrī Pādaliptasūri's Vīrastava. Another work of his is Rahasyakalpadruma which is not available. This shows that he was a great scholar. * He also helped Śrī Malliṣeṇasūri in writing 'Syādvāda Manjarī' and taught philosophical works like Śrīdhara's Nyāyakaṇḍalī to Śādhus of other Gacchas like Śrī Rājasekharasūri of Harṣapurīya Gaccha. He was also a Vidyāguru of Śrī Sanghatilakasūri.

We may note here the fact that both Śrī Jinaprabhasūri and his pupil Śrī Jinadevasūri rode elephants having been entreated by

Sultan Mahomed Taghluq to do so, when they returned to the Upāśraya (place for stay of Jain Sādhus) after their first interview with him. Caityavāsis used to do so formerly and their opponents considered it to be one of their lax practices. Sūrācārya did so and before him Siddhasena Divākara as well as Bappabhattsūri did so. It really illustrates the necessity for making exceptions even on the part of the ideal Sādhus on special occasions for the greater good of the Jain fold and for enhancing the credit of the Jain religion in the eye of the public.

The reasons why Śrī Jinaprabhasūri's services to the Jain Sangha do not appear to have been fully appreciated appear to be (i) that he was not in the main line of Khartaragaccha (ii) the unseemly quarrels which sometimes took place between members of different gacchas and (iii) the absence of a suitable biography. We consider his achievements even higher than those of Śrī Hīravijayasūri as religious bigotry was at its zenith in his times and he had to deal with a Sultan who was nicknamed 'the mad' owing to his senseless conduct devoid of reason. *

Śrī Guṇabhadrasūri, Śrī Munibhadrasūri, Śrī Mahendrasūri the famous astronomer and mathematician and Śrī Ratnaśekharasūri were recipients of great honours at the Court of Firoz Tughlaq. This shows that the position and influence acquired for the Jains by Śrī Jinaprabhasūri were retained during the reign of Firoz Tughlaq although the latter was a great fanatic and followed strictly verdicts of Ulemas and spared no pains to convert Hindus to Islam.

ŚRĪ JINAKUŚALASŪRI

After Śrī Jinadattasūri and Maṇidhāri Śrī Jinacandrasūri, it was Śrī Jinakuśalasūri who bore the honorific title of 'Dādāji'. He is equally famous as a great Māntrika as already stated. He was born in 1337 Vikram era at Samiyāṇā of Jilhāgar and Jayantaśrī parents of Chājhadagotra and

* For some of the information about Śrī Jinaprabhasūri the writer is indebted to the small but valuable Gujarāti book of his learned friend Pt. Lālacandra B. Gāndhi entitled "Śrī Jinaprabhasūri and Sultān Mahomed."

Oswāl Caste, was initiated in s. y. 1347, became Āchārya in s. y. 1377 Jyeṣṭha Vad 11th and died in s. y. 1389 Fālguna Vad 5th or 30th (Māru). 1200 Sādhus and 105 Sādhvīs were his pupils. He wrote a commentary on Caityavandana-Kulaka which is published at Surat. His another important work which seems to have been lost was VandanaKulaka-Vṛtti. There are several hymns composed by him. One of his pupils Śrī Vinayaprabha Upādhyāya composed the famous 'Gautamarāsā' in Gujarāti for his brother, who became rich again by recital of the Rāsa and Mantra incorporated therein. Many are the miracles attributed to his Māntric powers, one of them being the protection granted by him to Duṃgarsiṃha, a Rajput ruler of Nādol, against the wrath of the Sultan of Delhi (probably Sultan Mahomed Tughlaq or his predecessor Sultan Ghiyāsuddin Tughlaq) whereupon the whole family of Duṃgarsimha embraced Jainism. It is said that owing to his preachings and miraculous powers over 50,000 persons embraced Jainism. How, even after his death, protection is granted to his devotees immediately he is invoked—is illustrated by Śrī Samayasundara Upādhyāya by his own experience. He was in the Punjab and was crossing the Pañjnad* to go to Uchnagara in a boat. Suddenly, it began to rain heavily and the weather became stormy and the boat was about to capsize owing to whirlpool and sudden flood. He invoked Śrī Jinakuśalasūri and was brought to the shore safely. He composed a hymn to celebrate this escape commencing with the words "Āyo Āyojī Samarantā Dādoji Āyo". Similarly he says, at the commencement of Mṛgāvati Caritra, II Khanda, that on his being invoked in the city of Marot it rained immediately. This is the reason why shrines of 'Dādāji' are found in almost all places of importance. There are such shrines in several

* The confluence of the five rivers viz. Jhelum, Chenāb, Rāvi, Beās and Sutlej till they meet the Indus is known as Pañjnad. This is the place where Āchāryas of Kharataragaccha like Śrī Jinadattasūri, Śrī Jina-Kuśalasūri and Śrī Jinacandrasūri performed Sādhanā of the presiding deities thereof known as Panca Pīras viz. (1) Khadira (2) Lanjā (3) Kānhu (4) Somarāja and (5) Khañja and Śrī Māñibhadra and Khodiyā Kṣetrapāla.

temples in Bombay, one at Byculla temple being considered of special note. In practically every temple in the management of Kharataragaccha shrines of 'Dādāji' are usual by installed. The popularity of his worship can be easily judged by the great number of his shrines spread over hundreds of places in India. See the hymn of 108 Stupas of Śrī Jinakuśalasūri by Śrī Rājahaṛṣa.

ŚRĪ BHUVANATUṄGASŪRI

Śrī Bhuvanatuṅgasūri was an Āchārya of a branch of Ancalagaccha. He attained fame as a Māntrika as in a bout with snake-charmers he invoked Takṣaka Nāga the chief of the Nāgas (snakes) and made him appear in the royal court of Kheṅgāra IV (who ruled from 1336 to 1390 Vikrama era) at Junāgadh and none of the 16 Gārudis (snake-charmers) present could control Takṣaka. They were therefore declared defeated in the Māntric contest with Śrī Bhuvantuṅgasūri who in his turn controlled all the various Nāgas of the said Gārudis. As a result he made these Gārudis give up catching snakes and made the said King Kheṅgāra prohibit casting of 1½ lacs of fish-nets and stop 500 Bhaṭṭhis or ovens and accept the principle of Ahimsā or non-killing.

ŚRĪ MERUTUṄGASŪRI

Śrī Merutuṅgasūri was born of Porvād parents Vhorā Vairasiṃha and Nhālaṇade at Nāni village in Jirṇapur in Mārwar in 1403 Vikrama era. He was initiated by Śrī Mahendraprabhasūri of Ancalagaccha in 1418 and ordained Āchārya in 1426. After the death of Śrī Mahendraprabhasūri in 1444 he became the leader of his Gaccha in 1446 and died in 1471 Vikrama era. He was a poet of note besides being a grammarian and a scholar of the different systems of philosophy. He wrote Mahakāvya—great orclassical poems viz. (1) Nābhivaṃśa (2) Yadvavaṃśasambhava (3) Nemidūta and (4) Meghadūta etc. vying with the great Sanskṛta poets Kālidās and Māgha. His summary of the six systems of philosophy is Śaddarsāna—Samuccaya. His grammatical works are Dhātu-pārāyaṇa and a commentary on Kātantra. He wrote Sataka—Bhāṣya

and a commentary on Saptati-Bhāṣya, works relating to Karma philosophy. He also wrote Bhāvakarmaparakriyā, Śatapadikāsāroddhāra, Laghu Śatapadī, Dharmopadeśa, Śrī Kankālaya-Rasādhyāya, Suśrāddha-Kathā and commentaries on Upadeśamālā and the hymn 'Namutthuṇam'. The most important for our purpose is however his work 'Sūrimantra-Kalpasāroddhāra.' He also wrote a 'Padmāvati-Kalpa'. That he was an accomplished Māntrika * is proved by his achievements narrated in Ancala-Gaccha Pattāvali viz. by composing the hymn of Śrī Jīrikāpallī Pārśvanātha beginning with the words 'Om namo devadevāya etc.' in Lolād village near Sankheśvara-Tīrtha he warded off the threatened calamity and also caused the army of Sultan Mahomed§ to turn back from the said village by invocation of Śrī Pārśvanātha. Through the same hymn he cured the son of the Mayor of Vadanagar (a nāgara by caste) who was bitten by a snake. Consequently 300 Nāgara families accepted the Jain faith. The said hymn is published in Stotrasandoha part II at p. 48. The Mantra of Śrī Pārśvanātha incorporated therein is known as 'Tribhuvana-vijaya-patākā' i. e. 'The triumphal flag of the conquest of the three world.'

ŚRĪ MUNISUNDARASŪRI

Amongst Māntrikas Śrī Munisundarasūri is famous as the author of the Māntric hymn 'Santikaram', which is one of the Smaraṇas i. e. hymns meant for daily recital. The said hymn was composed by Śrī Munisundarasūri to ward off the epidemic caused by Yoginīs (powerful female deities) at Delwadā. He performed Sādhanā of the Sūrimantra, it is said, twenty-four times and became a great Mantrasiddha. That he was a great Upāsaka of Sūrimantra is clear

* He refers to his own experience thus in the hymn referred to further on.

“यथा नादमबो योगी तथा चेत् तन्मयो भवेत् ।
तदा न दुष्करं किञ्चित् कथ्यतेऽनुभवादिदम् ॥१०॥

§ The hymn also discloses his proficiency in practical Yoga, see also v.5 of the same hymn:

पूजाकोटि समं स्तोत्रं स्तोत्रकोटिसमो जपः ।

जपकोटिसमं ध्यानं ध्यानकोटिसमो लयः ॥ प्रबन्धकोश, रत्नश्रावकप्रबन्धः, श्लोक ३, पृ. ४

from the said hymn wherein he has invoked for removal of calamities Śrī Śāntināth and the presiding deities of the five Piṭhas of the Sūrimantra viz. Vāṇī alias Sarasvatī, Tribhuvanaswāminī, Śrīdevī alias Lakṣmī, Yakṣarāja Gaṇipiṭaka as also twenty four Śāsana Yakṣas and Yakṣinīs, Planetary deities, Guardian deities of the quarters, Indras, sixteen Vidyādevīs, the four kinds of deities, Vyantaras and Yoginīs devoted to the protection of the Tīrtha that is the Jain fold. The Colophon mentions that in the hymn the author employs the Siddhi relating to Gaṇadhara Vidyā obtained by the good grace of the preceptor Śrī Somasundara of Tapāgaccha. The writer has in his possession hymns by the same author of Sūrimantra and the presiding deities thereof which are not hitherto published. It appears from them that the author was a great Upāsaka of Sūrimantra.

We shall now shortly state such details of his life as are available. He was born in 1436 and initiated in 1443 Vikrama era. He was ordained Vācaka in 1466 and Āchārya in 1478 and died in 1503 Vikrama era at the age of 67 years. He had such an extraordinary memory as enabled him to attend to a thousand matters simultaneously. He was therefore known as Sahasrāvadhānī. He was a great poet and dialectician and being of dark complexion received the title of Kālī (Black) Sarasvatī and Vādigokula-Ṣandha i. e. a bull in the herd of cows of dialecticians. Owing to his great Māntric powers such prominent goddesses as Padmāvatī used to be at his beck and call and helped him in carrying out his self-less work for the welfare of all living beings. Sahasramalla a King of Sirohi proclaimed in his kingdom at the instance of the Āchārya prohibition against killing of living beings and Śrī Munisundarasūri warded off the calamity of famine threatened by swarms of locusts in the fields. He wrote several works amongst which are Adhyātma-Kalpadruma, Upadeśa-Ratnākara with a commentary, Jayānandacaritra, Tridaśataranginī (which included the available Gurvāvali) and several hymns including Śrī Jinastotraratnakōśa being a collection of hymns (I Prastāva of 23 hymns is published in Stotrasaṅgraha, part II).

SRI SUBHASUNDARAGANI

Sri Subhasundaragani composed the Delāulā Māntric hymn of Sri Rṣabha Jina styled Delavādāmandana. It also contains Yantras and medical prescriptions. The allusions to Munisundara and Lakṣmī-sāgara in the twenty fifth verse establish the author to be their contemporary. His life extended from about 1436 to 1517 Vikrama era. Other details of his life are not known. The said hymn with an Avacūri commentary is published at pp. 353 ff. in Jain Stotra Sandoha part I. The Avacūri appears to be by the author himself. There is assimilation of non-Jain Mantras and especially Laukika-Mantras and Śābara Mantras. There are references to Pancāṅgulidevī-Mantra and Aṭṭe-Maṭṭe Pārśvanātha-Mantra known as Tribhuvana-Vijaya-Patākā-Mantra and to the hymn incorporating the last Mantra composed by Sri Ajitasimha possibly of Añcalagaccha (1283-1339 Vikrama era). The peculiar bath described in the comment on the 23rd verse of the hymn is suggestive of the influence of popular Tāntrika treatment. The commentary on V. 17 contains the following interesting Mantra in which invocation is with the truth-telling nature of Sri Jina and other omniscient personages: “ॐ सच्चं भासद् अरिहा सच्चं भासद् केवलीमयवं । एएण सच्चवाएण एधं निमित्तं मा वभिचरउ स्वाहा ॥”

SRI HEMAVIMALASURI

Sri Hemavimalasuri was born of Gangārāj and Gangārāṇi parents in 1522, was named Hādakumāra, and was initiated by Sri Sumatisādhu in 1538 Vikrama era. He did Kriyoddhāra i. e. reinstated the original religious practices and observances in 1556. He was ordained Āchārya in 1548 and died about 1583 (1584 Māru) Vikrama era. He twice performed Sādhanā of Sūrimantra. It is said that he obtained a boon from Sri Māṇibhadra Yakṣa * and since his time Sri Māṇibhadra became the presiding and protecting deity of Tapāgaccha.

* “हेमविमलसुरि वरदाय”

See page 10 Māṇibhadradeva and Padmāvatīdevī's Chandas.

According to Tapāgaccha Pattāvali of Upādhyaya Śrī Dharmasāgara however it was Śrī Ānandavimalasūri pupil of Śrī Hemavimalasūri who appointed him as the presiding deity of Tapāgaccha.

ŚRĪ JINACANDRASŪRI

Śrī Jinacandrasūri was born at Vadali village near Timarinagar or at Khetasara in Jodhpur of Shah Śrīvant and Siriyādevī parents of Rihadagotra and Oswal Caste in 1595 Vikrama era and was named Sultān Kumara. He was initiated in 1604 and named Sumatidhīra and ordained Āchārya in 1612 and named Jinacandrasūri at Jesalmere when the occasion was celebrated by Raut Māladeva King of Jesalmere. At the instance of Karmasiṃha son of Minister Saṅgrāmasiṃha he went to Bikaner after effecting Kriyoddhāra by reinstating the old religious practices and observances. There he triumphed over the advocates of the heretic doctrine deprecating idol-worship. He also compelled fallen Yatis to give up the garb of Sādhus and put on turbans as an insignia of house-holders and made others follow religious injunctions strictly. By his prophetic and miraculous powers he made Sivā (Sadā) and Somjee two non-Jain brothers of Prāgvāt caste rich and they embraced the Jain faith with their families. He installed quadruple Jinas on Śrī Śatṛuñjaya and repaired and renovated the group of temples in Kharataravasahi there. Sadā and Somjee also built a temple of Śrī Śāntinātha in Dhanā Suthāra's Pole at Ahmedabad and installed therein an idol of their preceptor Śrī Jinacandrasūri. As stated in Kharatara Pattāvali he established before representatives of 84 Gacchas in 1617 Vikrama era that Śrī Abhayadevasūri who composed commentaries on nine Aṅgas belonged to Kharataragaccha and that Kumāti-Kuddāla a work of Upādhyāya Śrī Dharmasāgara of Tapāgaccha contained wrong statements and was not authoritative. By his miraculous powers the doors of the Jain temple at Falodhi, which were locked to bar his entry to the temple by the followers of Upādhyāya Śrī Dharmasāgara, flew open in 1632 Vikrama era. Emperor Akbar heard about him through minister Karma-candra and invited him to his court. On Fāgaṇa Sud 12th 1648 he

had thereupon an interview with Akbar at Lahore in course of which he impressed upon him the truth of the Jain doctrine and made him issue Firmāns—orders prohibiting killing of every sort for a week from Aṣādhā Sud 9th to 15th. Emperor Akbar conferred upon him the title of Yuga-pradhāna i. e. the leader of the age. At the instance of Akbar he conferred Āchāryaship on his pupil Mānasimha who was named Jinasimhasūri.

In 1652 Vikrama era he successfully performed at the confluence of the five rivers of the Punjab near Uchnagar the Sādhanā of the deities presiding over Pañjnad—viz 5 Pīras. Māṇibhadra Yakṣa, Khodiyā Kṣetrapāla and other deities. * In 1669 he made Emperor Salim-Jehāngir revoke the order issued by him prohibiting stay of Sādhus, who were not married, in his kingdom. He is known as one of the 'Dādās' amongst the followers of Kharataragaccha who believe that even after his death he helps his devotees whenever invoked by them and protects them as a grand-father would protect his grand children. He died at Bilādā in Mārwar on Āsvin Vad 2nd (Māru), and Bhadarvā Vad 2nd (Gujarāti), in 1670 Vikrama era. There are celebrations held on this day at Bombay, Surat, Broach, Pāṭana and other places every year.

UPĀDHYĀYA ŚRĪ ŚĀNTICANDRA

Upādhyāya Śrī Śānticandra was a pupil of Sakalacandra and a grand pupil of Śrī Vijayadānasūri, the preceptor of the famous Tapāgacchācārya Jagadguru Śrī Hīravijayasūri who convincingly preached the Jain doctrine to Emperor Akbar and impressed upon him the basic principle of Ahimsā or non-killing and obtained Firmāns from him prohibiting killing of every sort on certain days and during certain periods and abolishing Jaziā—tax, releasing prisoners and making a grant to Śrī Hīravijayasūri of holy places of pilgrimage of the Jains. Śrī Hīravijayasūri conferred the title of Upādhyāya on Śrī Śānticandra in

* See pp. 48—49 Kharataragaccha Pattāvalisaṅgraha by Śrī Jinavijaya. The authors of 'Yugapradhāna Śrī Jinacandrasūri' at p. 128 of their work give the names of the five Pīras; see also note p. 237 ante.

1640 Vikrama era. When Śrī Hīravijayasūri left Āgrā for Gujarāt in 1642 Vikrama era he left Upādhyāya Śrī Śānticandra with Akbar. Śānticandra also made Akbar prohibit fishing in the Dāmar lake near Fatehpur-Sikri. He composed Kṛpārasakośa a panegyric on the Emperor praising his humanity and merciful deeds. The work inspired Akbar to perform many merciful acts and charitable deeds including abolition of Jazia-tax and release of prisoners. He also wrote a commentary on one of the Upāṅgas Jambudvīpa-Prajñapti in 1650 Vikrama era.

Upādhyāya Śānticandra was a very learned man and could perform Satāvadhāna i. e. attend to a hundred things simultaneously. He was a great dialectician and triumphed over the Digambara disputant Bhaṭṭāraka Vādibhūṣaṇa in the Court of the King Nārāyaṇa of Idargadha and over Digambara Āchārya Guṇacandra in the presence of Śrī Mānadeva (nephew of the King of Jodhpur) at Ghāṭasīla in Vāgada. As for his magical powers it is stated in Paryuṣaṇa-aṣṭāhnikā-vyākhyāna (II Vyākhyāna, P. 5) of Śrī Vijayalakṣmīsūri that through his miraculous powers Akbar succeeded in taking the fort at Attock which he had not been able to do for several years. He died about 1660 Vikrama era as might be inferred from the addendum to the Colophon of his commentary on Śrī Jambudvīpa-prajñapti which was appended in 1660 by the revisers of the said Commentary after his death.

UPĀDHYĀYA ŚRĪ YAŚOVIJAYA

Śrī Yaśovijaya was born of Bania parents Nārāyaṇa and Saubhagyadevī at Kamhodu village near Dhiṇoj in or about 1680 Vikrama era and was named Jaśavant. He had a brother named Padmasiṃha. They came in contact with Śrī Nayavijaya and were taken by him to Śrī Vijayadevasūri who initiated them as Nayavijaya's pupils and named them Yaśovijaya and Padmavijay respectively. Śrī Yaśovijaya studied under his Guru and went with him to Ahmedabad in 1699 where he performed Aṣṭāvadhāna i. e. attended to eight things simultaneously. Thereupon one of the leaders of the Sangha there named Dhanji sūrā suggested that Śrī Yaśovijaya deserved to be sent to

Kāśī-Benares to study there the six systems of philosophy and that ultimately he might become an ornament to the Jain fold. He offered to spend Rs. 2000/-for the purpose. Thereupon both the preceptor and the pupil went to Kāśī. Śrī Yaśovijaya prosecuted his studies under a Bhaṭṭācārya versed in the six systems of Indian philosophy and proficient in logic and the art of dialectics. Paying a rupee every day as Gurudakṣiṇā or fee Śrī Yaśovijaya studied there for three years continuously. About the time a Sannyāsi disputant came to Benares who was defeated in a debate by Śrī Yaśovijaya before a meeting of Pandits. He then composed a hymn in praise of Śrī Pārsvanātha. He was then given the title of Nyāyaviśārada by the Pandits who had witnessed his great performance in the said debate. Then Śrī Yaśovijaya went to Āgrā for further prosecution of his studies particularly in logic of the New School termed Navya-Nyāya and studied the same under a Nyāyācārya for a further period of four years. The Sangha there offered to spend for him Rupees Seven hundred, which was accordingly spent for purchase of books and in giving scholarships and presents to other students. Śrī Yaśovijaya then went to Ahmedabad where he was welcomed by the Sangha there with great eclat and stayed at Nāgorisarāh. Mohabatkān the Subā of Gujarāt having heard about him invited him to his Court where he performed Aṣṭādaśavadhāna i. e. attended to eighteen things simulataneously. The Subā was very much pleased with his performance and praised him greatly.

The title of Upādhyāya was conferred on him in 1718 by Śrī Vijayaprabhasūri (the successor to Śrī Vijayadevasūri) after he performed the Viśasthānaka-worship and austerities. He also received the title of Nyāyācārya from the Pandits of Kāśī after he composed a hundred philosophical and logical treatises. This fact is mentioned by himself at the beginning of his commentary on Pratimāśataka and in the colophon of his another work Jain Tarkaparibhāṣā. He has also written several works ending with the word 'Rahasya' probably because the famous neo-logician Mathurānātha was his favourite author and

the latter had composed works bearing names ending with 'Rahasya'. He similarly wrote Maṅgalavāda, Vidhivāda as his contemporaries were using names ending with the word Vāda or Treatise.

He came in intimate contact with Yogīndra Śrī Ānandaghana, as appears from Aṣṭapadī or the panegyric of eight verses composed by him in praise of Śrī Ānandaghana.

He has made much use of 'Āloka' of the famous neo-logician Pakṣadharamiśra in his philosophical works. He was an allround scholar and wrote on philosophy, Yoga as well as Adhyātma. He has adopted several passages of Śrī Bhagavadgīta and Yogasūtra in his Adhyātma-sāra and Adhyātmopaniṣad and Dvātriṃśikās. He wrote a commentary on Kammāpayadī, an old work dealing with Karma philosophy. He wrote in Sanskr̥ta, Prākṛta and Gujarāti with equal ease and grace. He was a philosopher, logician as well as a poet. He also revised Dharmasaṃgraha of Upādhyāya Śrī Mānavijaya and the latter has praised him in its colophon for his vast learning, reasoning and disquisitions full of Pramāṇa comparing him to persons who equalled the omniscient through learning. His biographer Śrī Kāntivijaya called him 'दुर्बोद्धीसरस्वती' or 'Bearded Sarasvatī'.* It is unnecessary to enumerate here his many works. × He completed the famous Śrīpāla Rāsa in Gujarāti which was commenced by Upādhyāya Śrī Vinayavijaya. He has commenced almost all his works with the syllable 'Aim' being the Mantra-bīja sacred to Sarasvatī having obtained a boon from her at the conclusion of her Sādhanā performed by him on the bank of the Ganges in Benares. He has himself stated this fact in his works Mahāvīra-Stava alias Nyāya-khaṇḍanakhādyā and Jambuswāmi Rāsa respectively as follows:

* His authoritative biography is contained in 'Sujāśaveli' a metrical work composed by Śrī Kāntivijaya one of his contemporaries, a complete copy whereof was recently in S. Y. 1984 discovered by the writer's friend Mr. M. D. Desai.

× For a description of his works see pp. 643-645, Short History of Jaina Literature by M. D. Desai.

ऐं कारजापवरमाप्य कवित्ववित्त्ववाञ्छासुरद्रुमपगङ्गमभङ्गरत्नम् ।
सूक्तैर्विकसिकुसुमैस्ताव वीर शम्भोरम्भोजयोधरणयोर्वितनोमि पूजाम् ॥

—न्यायकाण्डनखाद्य

“Having obtained a boon, on the bank of the Ganges through the recital of ‘Aim’ (Mantra bīja sacred to Sarasvatī), the veritable wish-granting tree for fulfilling the desire for poetic and scholastic powers, and which gives continuous joy, I offer worship with full-blown flowers in the form of beautiful verses of praise to the feet of Śrī Mahāvīra who is real Sambhu.”

“शारद ! सार द्या करी आपो वयन सुरंग,

तुं तूडी मुञ्ज उपरे जप + करत छपअंग १

तर्क काव्यनो ते तदा दीधो वर अभिराम,

भाषा पश्चि कारि कल्पतरु शाखा सम परिधाम. २” —नञ्चुस्वाभिरास

He also wrote a small astrological work called Falā-fala-Pṛcchā (Jain Sāhitya-Saṁśodhaka Vol. III 2, pp. 162 to 165). He died at Dabhoi in 1743 and on Mahā Sud 5th 1745 a Stupa-tope was constructed there as a memorial to him and his footprints were installed therein. It is interesting to note that a Siddhacakra Yantra in the temple of Śrī Kalyāṇa Pārśvanātha at Vadācautā, Surat, which was installed according to the inscription thereon by Mahopādhyāya Śrī Yaśovijaya-gaṇi of Śrī Vijayadevasūrigaccha and got prepared by Śrī Fulbai daughter of Śrī Nāthibai on Poṣa Sud 1st, Sunday and Puṣya (asterism) s. y. 1737.

UPĀDHYĀYA ŚRĪ MEGHAVIJAYA

He flourished from about 1700 Vikrama era. He was a pupil of Kṛpāvijaya who was fifth in the line of the famous Jagadguru Śrī Hīravijayasūri. He was a grammarian, logician and poet and was also versed in astrology, palmistry and Mantraśāstra. His knowledge of Mantraśāstra can be gauged to an extent by perusal of his work on Viśā-Yantra (Diagrām of the number 20) which also describes

Arjuna-Patākā alias Vijaya-Yantra based on the diagram of the number 15 and its multiples and also by perusal of his Varṣa-prabodha alias Meghamahodaya as the latter contains Yantras and Mantras for causing as well as stopping rainfall and Sarvatobhadra and other Yantras. For a detailed description of his works the readers are referred to Mr. M. D. Desai's "Short History of Jaina Literature" pp. 651-655. We may mention however that his Sanskrit poems Devānandābhuyādaya, Meghadūta Samasyā and Śāntinātha Caritra are illustrations of completions of Samasyās—portions of verses taken from classical poems like Śiśupālavadhā, Meghadūta and Naiṣadhīya respectively. He also composed Digvijaya mahākāvya. His unique Saptasandhāna Mahākāvya describes simultaneously the biographies of five Tīrthaṅkaras viz. Śrī Rṣabhadeva, Śrī Śāntināth, Śrī Neminātha, Śrī Pārśvanātha and Śrī Mahāvīra and Śrī Rāmacandra and Śrī Kṛṣṇa each verse being applicable to the biographies of all the seven personages. This is sufficient to show his command over the Sanskrit language. He has composed a commentary on Vijayadeva-Mahātmya and also on Bhaktāmara Stotra of Śrī Mānataṅgasuri, Laghutriṣaṣṭhi Caritra and Pancākhyāna. His Candraprabhā is a parallel to Siddhanta Kaumudī and deals with the Sūtras of Siddhahema in the same manner as the latter deals with Paṇini's Sūtras. It is also in three versions—short, medium and large. His Udayadīpikā and Ramalaśāstra are works on astrology and divination through casting of dice and Hastasanjīvanī alias Siddhajñāna deals with palmistry. His Mātṛkāprasāda deals with Adhyātma. He also wrote Arhadgītā in 36 Adhyāyas and Brahmabodha. His Yuktīprabodha in Prākṛta with a Sanskrit commentary contains a refutation of the contentions of Banārasidās and his followers and Dharma Mañjuṣā contains a refutation of the contentions of Dhundhakas a sect of the Jains against idol-worship. He has also written some minor works in Gujarātī.

That he was a Māntrika is also proved by the fact that he begins almost all his works with a Mantra and obeisance to Śrī Sankheśvara Pārśvanātha. The Mantra is "ॐ ह्रीं श्रीं क्लीं भूर्भुवः स्वः नमः"

We cite here a passage from his Meghamahodaya pp. 68-69 in support of Mantric worship.

“भत्र देवाद्युपलक्षणाद् योगलब्धिमहातपःकृतापि वृष्टिः प्रयोगजन्या मन्तव्या । × × × ×
एवं च लौकिकलोकोत्तरशास्त्रविरुद्धं देवाः किं कुर्वन्ति ? योगमन्त्रादिप्रभावात् किं स्यात् ? सर्वे स्वकर्म-
कृत्यमित्यादिमूढवचो न प्रमाणीकार्यमित्यलं विस्तरेण । तन्नास्तिकमतं त्यक्त्वा प्रतिपद्यास्तिकागमम् ।
देवताराधने यत्नः कार्यः सम्यग्दृष्टाप्यहो ॥”

PANDIT ŚRĪ VIRAVIJAYA

Pandit Śrī Viravijaya was born at Ahmedabad, Santidas Pādo near Gheekāṅṭā, of Audicya Brāhmaṇa parents Yajneśvara and Vijkore on Āśo sud 10th 1829 Vikram era. He was named Keśavarām. He had a sister named Gangā. He was married to a lady named Raliāt at Dehgām before he attained the age of 18 years. As a result of some domestic quarrel between the mother and the son, the latter left home. The mother searched for him and learnt that he was at Rocaka village. He however did not return and the mother died heart-broken. It is said that his sister Gangā also on hearing this news died. Keśavarām after leaving home wandered from place to place till he met Śrī Subhavijaya either at Bhīmanātha village near Dholerā or at some place near Pālitāṅā. He was then seriously ill but recovered through the good offices of Śrī Subhavijaya. He then asked leave of Śrī Subhavijaya to return home, but the latter persuaded him to lead the life of a Sādhu and Keśavarām agreed. He was then initiated at Pānsar and named Viravijaya on Kartak Vad 1848. Then both went to Cambay and they entered Cambay in a procession taken out by the Sangha which had assembled on the outskirts of the city to receive them. Śrī Subhavijaya had previously thereto initiated two other pupils named Dhīravijaya and Bhāṇavijaya. Both the preceptor and the pupil stayed at Cambay for about five years i. e. upto Jeth Sud 5th 1853. During the period Śrī Viravijaya made great progress in his study of Sanskṛta, studied the five Mahākāvyas and the six systems of Indian philosophy as also the religious scriptures. The title of Pandit was thereafter conferred upon him some-time before his

preceptor died on Fāgan Vad 12th 1860 at Ahmedabad. Pandit Śrī Vīravijaya was greatly devoted to his Guru. His major works are Praśna–Cintāmaṇi* in Sanskr̥ta (1868) and Surasundarī Rāsa (1857), Dhammila Kuṇvara Rāsa (1896) and Candrasekhara Rāsa (1902) and commentary on Adhyātmasāra of Upādhyāya Śrī Yaśovijaya in Gujarāti. Amongst his minor works are Śubhaveli being the biography of his Guru in verse, Pūjās, Sajjāyas and Stavanas. The hymn of Śrī Mahāvīraswami's 27 births is of fine lyric quality. His Pūjās specially Panca Kalyāṇaka Pūjā (1889) contain pieces of beautiful lyric poetry. There is a Vīravijaya Nirvāṇa Rāsa written by his pupil Rangavijaya which gives authoritative information about his life. He lived at Surat during the monsoon of 1871. There yatis quarrelled with him apparently on the question of Tithi–Date i. e. which dates should be considered authoritative by the Jains and contended that Vīravijaya was wrong. They even went the length of going to Court on such a flimsy pretext, but there Śrī Vīravijaya successfully proved that his opinion was correct. Now this dispute arose really because Pandit Śrī Vīravijaya was a Saṃvegi or Reformist Sādhu in the line of the great Reformist Śrī Satyavijaya Pannyāsa (Pandit). In 1878 a member of the Dhundhiā or Sthānakavāsi section which was opposed to idol–worship filed a suit against the members of Viśā Śrīmāli caste of Ahmedabad and Vīravijaya was the leading Sādhu cited there as a witness. The sādhus of the other sect were also cited. There Vīravijaya successfully proved that idol–worship was in accordance with the Jain sacred scriptures. He was very learned in canonical literature and publicly expounded such abstruse philosophical work as Śrī Viśeṣāvaśyaka Bhāṣya with commentary. Since 1865 when an Upāśraya was built at Bhaṭṭhinī–Pole Ahmedabad, Vīravijaya whenever he came to Ahmedabad stayed there, and it came to be known after his name.

* See V. 6 which shows his having successfully performed Sādhanā of Sarasvatī:"

“श्री शारदा शारदशर्वरीशविभाविराज्युज्ज्वलकायकान्तिः ।

ममोज्ज्वलघ्यानपथावतीर्णा वाणीमपूर्वां विमलां तनोतु ॥”

He took a leading part in the Anjana-śalākā and installation ceremonies got performed by Seth Motiśa in his group of temples on Satruñjaya Hills in 1893 and also in similar ceremonies at Seth Haṭhsing's Temple at Ahmedabad in 1903. In 1899 he was in a Sangha going on a pilgrimage to Pancatīrtha. Before it left the borders of Gujarāt cholera broke out and people dispersed in small groups. The group which stuck to Śrī Vīravijaya was brought back by him safely to Ahmedabad, by his Māntric powers. At every stage on the way back Śrī Vīravijaya used to sprinkle charmed water around the camp.

In his Rāsās Śrī Vīravijaya has made special obeisance to Sarasvatī and Padmāvatī. The writer is reliably informed that Śrī Vīravijaya was a devoted worshipper of Padmāvatī and performed Māntric Sādhanā of Rakta (Red) Padmāvatī (See Appendix 3). *

The beauty and charm of his poetry are themselves sufficient proof of his being a gifted writer. He is a poet of the first order in Gujarāti and many of his lyric pieces entitle him to be called the Dayā-rām of the Jains. He died on Bhādarva Vad 3rd 1908. Vikrama era

Śrī Vīravijaya was so modest that although Śrī Vijayadevendrasūri Ācārya of Tapagaccha offered to confer upon him the title of Upādhyāya he did not agree to receive the same. It is said that Śrī Rūpavijaya was his rival in composition of Pūjās and Stavanas. His footprints were installed in the said Upāśraya at Bhaṭṭhini Pole on Mahā Sud 6th 1909.

Amongst his contemporaries was the poet Śrī Padmavijaya, the preceptor of the said Rūpavijaya who flourished from 1792 to 1862. Vikrama era

MUNI MAHĀRĀJA ŚRĪ MOHANLĀLJI

Śrī Mohanlālji was born at Cāndpur in Marwād of Brāhmaṇa parents Bādarmalji and Sunder on Caitra Vad 6th 1885 Vikrama era.

* The Rakta Padmāvatī Mantra is given here from the writer's collection:- ॐ द्रौ द्रौ
ल्लौ ल्लौ सः त्रिभुवनक्षोभिणी त्रिभुवनमोहिनी ह्रौ श्री रक्तपद्मावती नमः ॥

He was initiated as 'Yati' in 1903 by Śrī Mahendrasūri and was made a pupil of Śrī Rupacandji himself a pupil of Śrī Mahendrasūri and became a Saṃvegi (Reformist) Sādhu in 1931. In those times Bombay was not considered sufficiently holy for visit or stay of Sādhus. Sādhus used to come only upto Daman and never proceeded southwards beyond Daman. Śrī Mohanlālji considered it his duty to preach Jain doctrines to the Bombayites also and make them follow the path of religion. As a Saṃvegi Sādhu he visited Bombay for the first time in 1947 then again in 1951, 1952 and 1957. When in Bombay he so much impressed Jains as well as non-Jains by his simple holy life that he earned great respect and regard of all Bombayites without distinction of caste and creed whether rich or poor whether literate or illiterate. What impressed the people most was his pure and simple ascetic life. His unassuming nature and his preachings founded on the basic principles of all religions appealed to the heart of every one of his hearers. His speech seemed more to be the speech of a saintly soul rather than of a mere scholar. His hearers were impressed and convinced because his discourse appeared to be specially meant for every one of his hearers and suit them inspite of their divergent tastes. It always appeared to be a heart-to-heart talk. His manners were charming by their very simplicity. He seemed always to be frankly disclosing whatever passed in his mind. Although religious-minded he had sympathy and love for the worldly-minded and used always to guide them to better ways and simpler but higher sphere of life. By his holy life and saintly thoughts directed towards the welfare of every creature and his concentration on the ideal of Ahimsā he had so to say created a very holy and peaceful atmosphere around him and whosoever came in contact with his hallowed personlity enjoyed real peace of mind and many times such occasion became the turning point of his life. The writer though then very young had the privilege of hearing his very impressive discourses and he still retains the highest regard for his simple unassuming but truly humane, holy and ideally ascetic life.

Without his asking anyone specially, people spent lacs of rupees for religious and charitable purposes. The richest used to wait upon him daily to learn even by a mere word or hint of his pupils what would meet with his remotest desires and used to vie with each other to carry out the same. The period of his life prior to 1947 was really the preparatory ground for his immense popularity in his later life which went on increasing till he died at Surat on Chaiter Vad 12th 1963 Vikrama era. During the period of 16 years from 1947 to 1963 he spent monsoons at Surat in 1948 and 1950 and at Bombay in 1951 and 1952 and stayed at Surat during the monsoons of 1955 and 1956 and again stayed in Bombay from 1957 to Māgha 1963 and visited Surat last in 1963 when he departed this life. During the year 1949 he went with a Sangha on pilgrimage to Satrunjaya in Pālitāṇā and stayed there during the monsoon of that year. The monsoon of 1953 he spent at Ahmedabad and that of 1954 at Pātān. As a result of his preachings several Libraries and schools for religious and secular education and charitable funds were started at Bombay, Surat, Pālitāṇā and Ahmedabad. An Industrial school also imparting religious education named Rao Saheb Hirāchand Motichand Jhavery and A. S. Jayakore Udyogaśālā was started at Surat. There is a library and Sanskṛta Pāṭhaśālā established in his memory at Bombay which is even now rendering very useful services to the Jains as well as non-Jains.

We have already described the charming personality of Śrī Mohanlālji. Adverting to his Māntric powers, we apprehend that to describe particular incidents would involve mention of names of contemporaries so we would say generally that he was believed to possess Vacanasiddhi-miraculous power by which whatever he said came to pass. In or about 1930 when he was on the outskirts of Jaipur city and had to pass a night in the Jungle near a Vāv (a step-well) a tiger approached him. He thereupon stood in meditation in Kāyotsarga-pose. The tiger thereupon nodded his head and went away. In or about 1945 when he was at a place near Kaira, probably

Mātar about the month of Caitar, a buffalo was about to be sacrificed during Navarātra in the temple of a Hindu goddess. When pressed by the Jain Sangha to do something to save the buffalo he got charmed powder (vāsa) dropped on the buffalo and it immediately became wild and turbulent and escaped. Thenceforward the animal-sacrifice was discontinued there. He had much influence with the king of Sirohi and obtained permission from him for Jains to construct a temple with a turret at Rohidā which was being objected to by local Brāhmins and others.

Many have experienced what may be described in yaugic terms his Anugraha Sakti. Whomsoever he blessed became prosperous in every respect. People of Surat held him, and even now hold his memory in high regard, all attributing their prosperity to the blessings of the Guru Mahārāja Śrī Mohanlālji.* His photoes are to be seen in much greater number in the houses and shops of the Jains than of any other Jain Sādhu. His name is remembered in the morning by Jains as they remember the name of Śrī Gautama. Once when Śrī Mohanlālji was in Bombay the rain was delayed for a very long time and people became very anxious and a Rathayātra i. e. Procession with the idol of Śrī Jina installed in a chariot was taken out under his directions and the rain poured down immediately.

* “सुरते भावका अस्य धनिनोऽभवताशिषः ।

किंवदन्ती त्वयं सत्या कूर्वे कूर्चेऽपि लक्षणम् ॥”

—मोहनचरितम्, सर्ग १३ श्लो० ५०

Antiquity of Jain Mantras and Mantric Literature

WE have already stated that Vidyānupravāda, the tenth Pūrva, was entirely devoted to Mantras and Vidyās and that the Māntric literature comprised therein may be reasonably supposed to belong to the age of Śrī Pārśvanātha. We also indicated its possible connection with earlier Tīrthaṅkaras including the first Tīrthaṅkara Śrī Ṛṣbhadeva by reference to Kalpasūtra and the Jain tradition (See note p. 149 ante).

JAIN STŪPA AND OTHER ANTIQUITIES OF MATHURĀ

Tradition connects Śrī Pārśvanātha with the famous Jain Stūpa at Mathurā which has been described in the Inscription (No. XX Epigraphia Indica Vol. II) dated the year 79 of Kuśāna King Vāsudeva i.e. 157 A.D. as 'built by the Gods'. Smith says in his 'Jain Stūpa and other Antiquities of Mathurā' (p. 13):-

"Its original erection in brick in the time of Pārśvanātha the predecessor of Mahāvīra would fall at a date not later than B.C. 600. Considering the significance of the phrase in the inscription 'built by the Gods' as indicating that the building at about the beginning of the Christian era was believed to date from a period of mythical antiquity, the date B.C.600 for its first erection is not too early. Probably, therefore, this stūpa of which Dr. Fuhrer exposed the foundations is the oldest building known in India."

Śrī Jinaprabhasūri also in Mathurāpurī Kalpa contained in his work Vividha-Tīrtha-Kalpa p. 19 describes it as built by Gods (देवनिर्मितभूम्), and in his Caturaṣīti-Mahātīrtha-nāmasaṅgraha-kalpa he describes it as 'built by Mahālakṣmī' (मथुरायामहालक्ष्मीनिर्मितः श्रीसुपार्श्वस्तूपः), the name Mahālakṣmī being perhaps taken to be a synonym for Kuberā, Kubera being the famous god of wealth and Kuberā being his female counterpart and therefore identified with Mahālakṣmī.

According to the account contained in the said Mathurāpurī Kalpa the original Stūpa was of gold and built by Kuberā, a sylvan

deity presiding over the forest where two Sādhus in the 'Tīrtha' (spiritual regime) of Śrī Supārśvanātha spent the monsoon, as she was much pleased at their saintly character and severe austerities, and wished that their desire to make obeisance, along with the Sangha, to the images of Jina on Mt. Meru might be fulfilled. It was a representation of Meru with its triple girdles and four idols of Jina facing the four quarters on each of the three girdles. A dispute arose amongst the followers of different religions regarding the ownership of the Stūpa, and it was agreed that the same should be decided by divine intercession and that the disputants should for that purpose keep vigil during the night and worship the particular gods they believed in by burning incense etc. before their representations on Paṭa (canvas or a piece of cloth). In a cyclone which occurred during the night all the Paṭas except that of Śrī Supārśvanātha were torn and destroyed. Consequently the Stūpa was declared to belong to the Jains. In the time of Śrī Pārśvanātha the Stūpa was encased in bricks as a precaution against bad times predicted by Śrī Pārśvanātha. A temple was built outside the Stūpa and an idol of Śrī Pārśvanātha was installed therein. The Stūpa was ultimately repaired at the instance of Śrī Bappabhaṭṭisūri in 1300 Vīra era. The said account and the various images and Āyāgapaṭas discovered from the excavations of the Stūpa are important to prove ancient worship of Āyāgapaṭa and Paṭas in general as also of Sarasvatī and Ambikā whose images have been found from the excavations by Dr. Fuhrer. Mathurā Inscription No II (Vienna oriental journal Vol. III 1889) relates to the dedication of the image of Sarasvatī in the year 84 of Kuśāna kings i. e. 162 or 172 A.D. The Mathurā image of Śrī Ambikā is preserved in the Indian Museum, Calcutta. It is made of red stone. Other early images of Ambikā are the rock-cut images in the Navamuni cave, Khaṇḍagiri, Orissa and at Dhānk* in Kathiawar. The importance of these images of Sarasvatī and Ambikā is that they

* "Stylistically also the (Dhānk) sculptures belong to the early fourth century between Kuśānas or (Kṣatrapas) and the Guptas"—Dr. H. D. Sankalia, P. 430 J. R. A. S. 1938.

are independent and not merely as attendant deities. They, therefore, prove independent ancient worship of Sarasvatī and Ambikā.

POPULAR JAIN DEITIES

There is mention of both Sarasvatī and Ambikā in Nirvāṇa-kalikā but not Kubērā. Subsequent works on installation ceremonies dealing with Śāntikavidhi—Propitiatory rites include special verses in praise of Kubērā the deity presiding over the Jain Stūpa at Mathurā and Acchuptā (a Vidyādevī, see p. 38 Nirvāṇa Kalikā) besides the popular Śāsandevatās⁺ viz. Apraticakrā, Padmāvati, Ambikā and Siddhāyikā. Śrī Jinaprabhasūri gives these verses in Nandirayaṇavihi, Vidhiprapā p. 30. As in Mahāniśītha Sūtra Śrutadevatā or Sarasvatī, Āmrakuṣmāṇḍi, Acchuptā and Indrāṇi are mentioned as standards of comparison they appear to be very popular from ancient times.* The reason of the popularity of the four deities mentioned above is probably that Apraticakrā, Padmāvati, Ambikā and Siddhāyikā are respectively the deities presiding over the famous Tīrthas Śatruñjaya, Sammetaśikhara alias Pārśvanātha hills, Girnār and Pāvāpuri—Vaibhāra hills. As the Jains gradually moved to Western India Girnār and Ambikā gained in importance. Śatruñjaya in ancient times had fallen

+ According to Rūpamaṇḍana images of Śrī Ādinātha, Śrī Nemināth, Śrī Pārśvanātha and Śrī Mahāvīra are endowed with miraculous qualities as also image of Śrī Cakreśvarī, Śrī Ambikā, Śrī Padmāvati and Śrī Siddhāyikā and are especially worshipped:

“जिनस्य मूर्तयोऽनन्ताः पूजिताः सर्वाः सौख्यदाः ।

चतस्रोऽतिशयैर्युक्तास्तासां पूज्या विशेषतः ॥२५॥

श्री भादिनाथो नेमिश्च पार्श्वो वीरचतुर्थकः ।

चक्रेश्वर्यम्बिका पद्मावती सिद्धायिकेति च ॥२६॥” रूपमंडन अध्याय ६, पृ. ४५.

* “सेणंपूज्या × × × सेणं सुयदेवया [सेणं सरस्सई] सेणं अंबाहुंडी सेणं अच्युत्ता सेणं इन्दाणी ।”

Adh. II Uddeśa 8, Mahāniśītha; (Ms. p. II A) see also the following in Panca-Kalpabhāṣya, 5th Kalpa where Kusmāṇḍī alias Ambikā is invoked along with Sarasvatī for obtaining learning:

“सम्बसूयसमूहमती वामकरे गहियपोत्थिया देवी ।

जक्सकुहुंडीसहिया देतु अविग्घं मम नाणम् ॥

into the hands of the Buddhists. It is said that even Kapardiyakṣa, one of the presiding deities thereof, when Śrī Vajraswāmi in the beginning of the Christian era visited Śatruñjaya, had turned heretic and was replaced by another deity by Śrī Vajraswāmi. During that period Girnār was the only Tīrtha which could be easily visited by Jains in Western India. Girnār therefore became a popular place of pilgrimage and Śrī Ambikā came to be considered the Jain Āmnāya × deity. Śrī Apraticakrā or Cakreśvarī being connected with Panca-Parameṣṭi-Mantra and the Sūrimantra-Yantra and Siddhacakra-Yantra continued to be a popular Māntric deity. Śrī Padmāvati being connected with Śrī Pārśvanātha the ideal of Māntrikas and the most popular Tīrthaṅkara who earned the title of Purisādāṇīya has continued to be an equally popular Māntric deity. The importance of Śrī Siddhāyikā is owing to her being an attendant deity of the last Tīrthaṅkara Śrī Mahāvīra.

VIDYĀDEVĪS

The worship of Vidyādevīs amongst Jains is most ancient as would be evident from references given further on.

They are essentially Māntric deities presiding over all Māntric literature. Of course as Śrutadevī alias Sarasvatī is the deity presiding over the whole literature sacred as well as secular, she occupies the pre-eminent position amongst Māntric deities, and Vidyādevīs are considered deities allied to her but holding comparatively a subsidiary position. In the Jain pantheon Śāsana-Yakṣas and Śāsana-Yakṣiṇīs are concerned with the protection of the Jain fold and the Jain doctrine.

AMBIKĀ AND OTHER MĀNTRIC DEITIES

Śrī Ambikā appears to have been invoked on various occasions

× “तत्र देव्यन्विधा प्रासाददेव्यः १ संप्रदायदेव्यः २ कुलदेव्यश्च ३ । × × × संप्रदायदेव्यः अम्बा सरस्वती त्रिपुरा तारा प्रभृतयः” (भाचारदिनकर पृ. २०६);

“यासां च देवीनां अप्रसिद्धत्वात् कल्पादर्शनात् गुरुपदेशाभावात् नामोद्दिष्टो मन्त्रो न ज्ञायते तासां अम्बामन्त्रेण वा चण्डीमन्त्रेण वा त्रिपुरामन्त्रेण वा प्रतिष्ठा विधेया । अत्र देवीप्रतिष्ठायां शासनदेवीगच्छदेवी-कुलदेवीपुरदेवीभुवनदेवीक्षेत्रदेवीदुर्गादेवीनां सर्वासामेक एव प्रतिष्ठाविधिः ।” (भाचारदिनकर पृ. २१०).

by various Āchāryas and laymen for the fulfilment of the objects of the Sangha. We have seen how Priyagrānthisūri invoked her and succeeded in impressing the Jain doctrine of Ahimsā on the Brahmanas intent on the sacrifice of a goat. Māndevasūri, different from the author of Laghuśānti, once forgot the text of Sūrimantra and learnt the same again by invoking Ambikā. The famous Haribhadrasūri was aided by Śrī Ambikā * when he defeated the Buddhists who were assisted by their patron-deity Tārā in the debate. Bappabhaṭṭisūri was aided by Śrī Ambikā in his dispute with the Digambaras regarding precedence in worship at Girnār. It is unnecessary to multiply instances of worship of Śrī Ambikā amongst Jains in the ancient times. We may conveniently mention here that this fact is borne out by the poetic literature consisting of hymns viz. Caturviṃśati Stotras and Stutis. We would specifically mention Caturviṃśatikā Stutis by Śrī Bappabhaṭṭisūri, Śrī Sobhanamuni and Nyāyaviśārada Śrī Yaśovijayaji. All the three have verses in praise of Sarsvatī, Vidyādevīs and also in praise of Śrī Ambikā although she is not a Vidyādevī but is a Śāsandevī particularly an attendant deity of Śrī Neminātha. As the Stutis relate to the twenty-four Tīrthankaras verses in praise of 24 Śāsandevīs would have been quite appropriate. But the fact that Vidyādevīs are praised instead shows the ancient character of their worship and also of Māntric worship. Bappabhaṭṭisūri has twice praised Vairoṭyā, × the chief queen of Dharaṇendra and Kapardiyakṣa. In his times they must have been amongst Māntric deities usually worshipped. Sobhanamuni has additionally praised Śāntidevatā and Brahmaśāntiyakṣa (See also p. 7 & p. 8 Nirvāṇakalikā), who must have been therefore amongst the Māntric deities commonly worshipped in his times. Śrī Yaśovijayaji has several

* See Śrī Haribhadrasūri's commentary on Āvaśyakasūtra p. 411 for mention of Ambā and other deities. See also foot-note on page 204 ante.

× We have Vairoṭyāstava of much earlier date by Āryanandila wherein both Śrī Vairoṭyā and Śrī Padmāvatī are described as queens of Śrī Dharaṇendra. See also p. 36 & p. 38 Nirvāṇakalikā.

verses in praise of Sarasvatī instead. It is quite natural in his case as he is known to have been an Upāsaka of Sarasvatī. Further instead of Vairoṭyā he praises Śrī Padmāvati which shows that worship of Padmāvati was more common in his times. Śrī Jinaprabhasūri also in his Caturviṃśatistava (Kāvyaṃālā Part VII p. 170) praises Sarasvatī and Ambikā. The same is the case with Caturviṃśatistuti by Śrī Dharmaghoṣasūri. In the numerous hymns composed in the intermediate period of 700 years between Śrī Sobhanamuni and Śrī Yaśovijayaji Sarasvatī appears to have been usually praised varied some-times by the praise of Śāsandevīs, but worship of Sarsvatī and Ambikā seems to have been current uninterruptedly from the most ancient times to this day.

Referring to 'Aindrastuti' by Śrī Yaśovijayaji the prefernce of Śrī Yaśovijaya for praise of Sarasvatī instead of Yakṣas might be noted. The fact that the worship of Brahmaśānti and Kapardiyakṣa had gone out of vogue during the interval of 700 years between Śrī Sobhana muni and Śrī Yaśovijaya might account for it. The available Māntric literature also confirms this inference, as it does not include Mantra Kalpas of these Yakṣas. (In an unpublished list of manuscripts of the first and second Stambhas of Bhāṭhaṅki Kuṇḍi at Jeselmer dealing with Mantra Medicine and Astrology bearing No. 843 to No. 1004—a copy of which is with the writer—there is a Kapardiyakṣārādhanā—Kalpa being No. 877—7 leaves. But it is not available anywhere else).

VIDYĀDEVĪS AND ORIGIN OF VIDYĀDHARAS

As promised we shall now deal with the origin of Vidyādharas and worship of the Vidyādevīs. The oldest account as to the origin of Vidyādharas and worship of the Vidyādevīs is found at pp. 163–164 Vasudevahīṇḍi of Śrī Sanghadāsagaṇi (circa 600 A. D.). A similar account is given at pp. 161–162 of Āvaśyaka Cūrṇi as well as at pp. 143–144 of Śrī Haribhadrasūri's commentary.

Briefly it says that in times of S'rī Rṣabhadeva after he renounced the world and turned an ascetic, two princes named Nami and Vinami

sons of Kaccha and Mahākaccha, followed him from place to place, attended upon him sword in hand and served him zealously. Dharṇendra, the king of snake-deities, who came to make obeisance to the lord, saw them serving the lord humbly, diligently and respectfully. Out of curiosity he inquired what their object was in thus serving the lord. They replied that the lord distributed lands amongst his sons and other Kṣatriyas when they were in a distant country and that they were then serving the lord in order that the lord might do them some favour. Dharṇendra replied with a smile that the lord was beyond favour and disfavour and indifferent even to his own body, was without any possessions or belongings and free from attachment like a lotus, and that as they had however served the lord for a long time he would give them lands on both the sides of Mt. Vaiṭādhya as its reward. As the lands were not approachable on foot, he said that, he would give them the flying-lore and also other Vidyās with the aid of which they might induce people to go with them there. They thanked him and Dharṇendra gave them forty-eight thousand Vidyās of Gandharvas (Deities) and Pannagas (Snake-deities) including amongst them Mahārohiṇī,* Prajnapti, Gaurī, Vidyunmukhī Mahājwālā, Tiras-kāriṇi, Bahurūpā and others. Nami and Vinami founded on the South and North sides of Mt. Vaiṭādhya fifty and sixty towns respectively. Their subjects were divided in sixteen Nikāyās or groups, eight Nikāyās belonging to Nami and the other eight to Vinami. The respective groups took their names from the names of the Vidyādevīs presiding over them e. g. Gaurikas from Gaurī, Gāndhāras from Gāndhārī, Mānavas from Mānavī, Mātaṅgas from Mātaṅgī, Kālakesās from Kālikā etc. They installed Lord Ṛṣabha in the courts in their towns as also the particular Vidyādevī presiding over the particular group of Vidyādharas.†

* Āvaśyakacūrṇī additionally mentions that amongst the forty-eight thousand Vidyās Gaurī, Gandhārī Rohiṇī and Prajnapti are Mahāvidyās.

† Śrī Dharṇendra laid down rules for the observance of Vidyādharas: (1) No one

Thus arose the Vidyādharas. We may refer the readers to p. 176 ante for an account of some Vidyādharas who flourished about the time of Śrī Mahāvīra.

Most of the stories comprised in Vasudevahiṇḍi relate to Vidyādharas and their achievements through the employment of Vidyās which are nearly forty in numbers. Mahājwālā is described there as the most powerful Vidyā being counter to all other Vidyās. An interesting account of Sādhanā of Mahājwālā and other Vidyās involving worship of Sañjayanta and Dharmendra appears at p. 318 et seq. Vasudevahiṇḍi Pt. II. The reader interested in them may refer to them himself. What is comparatively of greater importance for our purpose is the enumeration of a number of Vidyās in one of the most ancient Aṅga viz. Sūyagadāṅgasūtra, II Śruta Skandha, Adh. 2, Sūtra 30 p. 318

SŪTRAKṚTĀṄGA-VIDYĀS

The said Sūtra calls those who employ Vidyās for the purpose of getting food, drink, clothing, bedding, house or any other object of enjoyment, non-Āryans and misguided and states that such persons would after their death become demons or pariahs amongst gods and would thereafter be reborn quite dumb and blind as a result of such misuse of Vidyās. It is clear that what the passage condemns is the employment of Vidyās out of selfish motives. The Vidyās are therein classed amongst Pāpaśruta i. e. sinful or evil learning

About forty Vidyās are enumerated in the said Sūtra of which twenty eight are Vidyās proper and the remaining twelve are meant for astrological predictions. They are explained in the commentary on the said Sūtra. The famous Tāntric Śaṭkarmas and many other objects are said to be achieved by these Vidyās. One of the Vidyās Ātharvaṇi—apparently connected with Atharvaveda—is said to cause injury to another at once. This would support what we have stated before that Tantra and Mantra

shall in any way offend a Sādhu (ii) nor offend or do injury to a person who has taken refuge in a Jain temple (iii) nor abduct a woman against her will and that if any one transgressed these rules he would lose his Vidyās. P. 227 Vasudevahiṇḍi Pt. II.

have their origin in Atharvaveda. Pākaśāsanī is the same as Indrajāla causing illusions, Mohanakarā causes fascination or infatuation, Garbhakarā brings about conception, Durbhagākarā makes even a good-looking person ugly and Subhagākarā even an ugly person good-looking. Vaitālī attacks with a staff and Ardhavaitālī counteracts the former. Avaswāpinī causes deep sleep, Tālodghāṭanī opens locks, Śvapākī is a Vidyā of Cāndālas otherwise known as Mātaṅgī*. Śāambarī, Drāvidī and Kāliṅgī are so called because they are connected with the respective countries of Sambaras, Dravidas and Kaliṅgas or are composed in their respective languages. Gaurī and Gāndharī are amongst the sixteen Jain Mahāvidyās. Avapatanī causes one to fall down and Utpatanī to rise up. The latter is the same as the flying-lore. Jṛmbhaṇī terrifies the opponent, Stambhinī paralyses them. Śleśaṇī means either one which sets a thing on fire or joins things together, Āmayakaraṇī causes or spreads disease, Viśalyakaraṇī removes foreign substances like arrow-heads etc. from the body and heals it up. Prakrāmaṇī causes swift forward movement. Antardhānī causes persons and things to disappear. Āyamaṇī means that which lengthens out or stretches forth; if it stands for Āchamanī it means one which swallows up. *

VASUDEVAHINDI-VIDYĀS

Of these Avaswāpinī, Tālodghāṭanī, Gaurī, Gāndhārī Jṛmbhaṇī Stambhanī, Vaitālī, Śvapākī-Mātaṅgī and Tiraṣkaraṇī-Antardhānī are also found amongst Vidyās described in Vasudevahiṇḍī. The first two and the fifth are mentioned at page, 7, eighth at page 84, sixth at pp. 317-319 and the remaining at p. 164 of Vasudevahiṇḍī. For names

× Gaurī and Gāndharī are described as Mātaṅga-Vidyās in Nis'iṭha Bhāṣya Udd. XVI v. 63 and Bṛhat-Kalpa Udd. I, v. 2508. See also Paris'iṣṭha Parva II, where two Vidyādharas marry Cāṇḍālakanyās to acquire accomplishment in a particular Vidyā.

* We would note here other references to Vidyā and Mantra occurring in Sūtrakṛtāṅga or in its Niryukti. Mantra: Sūtrakṛtāṅga, Adh. VIII v. 4, p. 168; Vidyā-Mantra: Niryukti v. 98, p. 169; Mantra: Sūtrakṛtāṅga, Adh. 14 v. 20, p. 248.

of Vidyās mentioned at various places in Vasudevahiṇḍi see appendix IV, 74, at p. 51 Vasudeva hiṇḍi Part II. It also mentions Mahārohiṇī Prjnapti, Mahājwālā Mānavī and Kālī besides Gaurī and Gāndhārī, mentioned above who are amongst the 16 Jain Mahāvidyās.

JWĀLĀMĀLINĪ AND DIGAMBARA JAIN MĀNTRIKAS

We have already stated that according to Vasudevahiṇḍi the most powerful Vidyā is Mahājwālā alias Mahājwālīni alias Jwālāmālinī. Vidyādharas accomplished in this Vidyā are there described to be always victorious over their opponents who may be accomplished in other Vidyās. This is, perhaps, the reason why this Vidyādevī, who is also the attendant deity—Śāsandevī of the eighth Tīrthaṅkara Śrī Candraprabha, is popularly worshipped and has independent Mantra-kalpas. The oldest Mantrakalpa available of Śrī Jwālāmālinī alias Jwālīnī is of Śrī Helācārya alias Elācārya a Digambara Ācharya and a Mānika of great repute. He has also composed a hymn in praise of the deity. There is another Kalpa by Śrī Indranandi, also a Digambara Jain Āchārya, based upon the said old Kalpa of Śrī Helācārya. Śrī Malliṣeṇasūri, author of the present work—Śrī Bhairava Padmāvātī kalpa has included in his “Vidyānuśāsana”, an abridged Jwālāmālinī Kalpa and has also composed an independent Mantra-Kalpa of this deity. We may note here that according to the Digambara tradition famous Mantrasiddhas began with Śrī Pūjyapāda (6th century Vikrama era) followed by the said Śrī Helācārya (of Drāvida Sangha) who flourished circa 9th century Vikrama era and Śrī Indranandi (of Drāvida Sangha) who flourished circa 996 Vikrama era i.e. Śaka 861. Then came the author of the present work Śrī Malliṣeṇasūri who was followed by Śrī Subhacandrācārya, author of Jnānārṇava, Bhaṭṭāraka Śrī Ariṣṭanemi and Bhaṭṭāraka Śrī Subhacandra (circa s.y. 1608), who was a pupil of the famous Bhaṭṭāraka Jnānabhūṣaṇa. Śrī Ariṣṭanemi wrote Śrī Śrīdevī Kalpa and Śrī Subhacandra wrote Śrī Ambikākalpa. There have been others also of lesser note who need not be mentioned here. ✕

✕ Bhaṭṭāraka Siṃhanandi (circa 16th century Vikrama era) wrote ‘Namaskāra-Mantra-

PAUMACARIYAM, PADMACARITRA, TRIṢAṢṬHIŚALĀKĀPURUṢACARITRA
AND VIDYĀS

There are several references to Vidyās in Paumacariyam. It is a work composed in 530 Vīra era, i.e. 60 Vikrama era according to its colophon. Its author Vimalasūri describes himself as belonging to Nāila Kula. Now Nāila Kula is synonymous with Nāila Sakhā which started from Ārya Nāila a pupil of Śrī Vajrasena about 150 Vikrama era.* So the work may be taken to have been written about that date. Jacobi considered it to be not earlier than the 4th or 5th century A.D. Dr. Kieth, Dr. Woolner and some other scholars considered it to be of about 3rd century A.D. because of the occurrence in the work of the word Dinār and certain Greek astrological terms; but Dr. Winternitz, Dr. Leumann and other scholars consider that there is no justification for doubting the date 530 Vīra era given in the colophon of the work itself.

We would draw the attention of the readers particularly to the passage occurring in the 7th Uddeśa from v. 135 to v. 145. About 61 Vidyās are enumerated in the said passage. Their names generally indicate the objects achieved through them. Amongst them may be noted Prajnapti which is one of the 16 Jain Mahāvīdyās and Aṇimā and Laghimā two of the well known eight Siddhis (Aṣṭasiddhi). The flying lore is stated there to have been acquired by Rāvaṇa, Bhānukarṇa alias Kumbhakarṇa as also Bibhīṣaṇa.

Of the Vidyās named in the said passage Prajnaptī is also found in the passage from Vasudevahiṇḍī (p. 164) referred to above.

kalpa'; Guṇanandi (circa 16th century Vikrama era) wrote Rṣimaṇḍala-Yantra-Pūjā; Arhaddāsa a contemporary of Āśādhara wrote Sarasvatīkalpa and Āśādhara (1235 to 1300 Vikrama era) wrote Gaṇadharavalaya and Pratiṣṭhāsāroddhāra alias Jinayajna-kalpa'. Padmanandi (1385-1450 Vikrama era) who made an image of Sarasvatī speak and Trikālya Yogi (circa 11th century) are some of the other Digambara Jain Māntrikas.

* See Vīranirvāṇa Samvat and Jain Kālagāṇanā P. 123.

Stambhinī noted above as a common Vidyā is found here as Jalastambhinī (one which freezes or stops water) and Agnistambhinī (one which cools down or extinguishes fire). Jayā and Vijayā may also be noted, as these Vidyās and the deities of identical names presiding over them are mentioned in Sūrimantra as well as Vardhamāna Vidyā. The Prākṛta Vāubbhavā might mean Vāgudbhavā i.e. Sarasvatī or Vāyūdbhavā meaning one that generates stormy wind or cyclone. Isānī, Shaktī and Kauberī are Vidyās apparently connected with Sankara, Shaktī and Kubera. Cāndālī is the same as Svapākī or Mātāṅgī and Nindrāṇī is the same as Avaswāpinī noted above. The flying lore is here thrice referred to. It is also mentioned in Vasudevahiṇḍī and as Utpatanī in Sūtrakṛtāṅga. Bandhanī (one which binds) and Mocanī (one which releases) are also found in Vasudevahiṇḍī.

We should note here the fact that Padmacarita alias Padmapurāṇa, which appears to be a very close Sanskrit rendering by Śrī Raviṣeṇa a Digambara Jain Āchārya (634 Vikrama era) of Paumacariyam, has the said passage from Paumacariyam rendered verbatim in Sanskrit. There are two or three differences which can be accounted for by variant readings. We might however, note one which cannot perhaps be so accounted for: Adarśanī for Visannā. Adarśanī can be identified with Tiraṣkariṇī alias Antardhānī already mentioned. Instead of Avaswāpinī we have Nindrāṇī.

Śrī Hemacandrācārya in Triṣaṣṭhiśalākāpuruṣacaritra Parva 7, canto 2 appears to have taken the said passage describing Vidyās from the said Padmacaritra but has additionally mentioned Rohiṇī, Gaurī and Gandhārī, which are mentioned in Vasudevahiṇḍī as well as in Āvaśyakacūrnī (pp. 161–162) as Mahāvidyās. All the three works describe Rāvaṇa as accomplished in 1000 Vidyās. (See Pauma. VIII, 6; Padma. IX, 134—all Vidyās; and Triṣaṣṭhi loc.cit.).

The importance of the above references is that they occur in works which were composed long before the influence of Tāntrikas made itself felt on contemporary literature and at least as regards

Sūtrakṛtāṅga in a work composed earlier than even the origin of Tantras.

They prove the existence of Vidyās not only about the time these works were written but also in very ancient times specially because they are described in such a matter-of-fact way in Sūtrakṛtāṅga and are associated with legendary characters of great antiquity described in the said subsequent works.

ŚRĪ, HRĪ, DHṚTI, KĪRTI, BUDDHĪ & LAKṢMĪ

We have already shown existence of Jain Māntric deities in olden times. We might here refer to the footnote on page 201 ante giving a reference from Śrī Bhagavatī Sūtra IX, 11, Sūtra 430 to a marriage-present of the idols of the six deities. Śrī, Hrī, Dhṛti, Kīrti, Buddhī and Lakṣmī. They seem to have been chosen as marriage-present because they are believed to bring prosperity. It was Hrīdevī amongst these who inspired Udyotanasūri otherwise known as Dākṣinya-cinha to write his beautiful story named Kuvalayamālā.

JAIN NARRATIVE LITERATURE VIDYĀS AND MANTRAS

Not merely the works already referred to but the whole of the Jain narrative literature is full of stories containing descriptions of miraculous achievements performed through the aid of Mantra, Maṇi* or gems, or Medicine and of Vidyādhara, Mantra-sādhanās and their incidental dangers. We would particularly refer to Śrī Haribhadrasūri's Samarāiccakahā, the said Kuvalayamālā, Śrī Siddharṣi's Upamitibhava-prapañcā-Kathā ×, Śrī Dhanapāla's Tilakamanjarī, Śrī Lakṣmaṇagaṇi's Supāsanāha-cariyam and Śrī Hemacandrācārya's Trisaṣṭhi-salākā-puruṣa-caritra and Śrī Somaprabhācārya's Kumārapāla-Pratibodha.

We shall give some references from Tilakamanjarī. At p. 25 ff. occurs Māntric initiation of the king when he obtained Aparājitā Vidyā for Sādhanā of Rājalakṣmī; at p. 37 occurs worship of Śrī and at p.

* अचिन्त्यः खलु प्रभावो मन्त्रमणिरोषधीनाम् ।

× Its famous author Siddharṣi calls it composed by the goddess of speech (गीर्देवतया विहिता) in the colophon thereof.

326 ff. occurs Sādhanā of Vidyās through Māntric worship of their idols. Eight chief Vidyās including Prajnapti and Rohiṇī are there described. They come to this world from heavenly nether regions to offer boons to the Sādhaka. This last is an important reference as it shows that of the sixteen chief Vidyādevīs presiding over the two regions of Vaitādhyā eight are described as they preside over one of the said two regions. Limitation of space does not permit us to discuss the numerous references even from the works already named. We would refer the curious reader to the article "Magic and Miracle in Jain Literature" by Kalipada Mitra commenced in The Jain Antiquary Vol. VII No. II p. 81 and continued in subsequent issues.

AUSPICIOUS AND PROTECTIVE MĀNTRIC RITES

We must however state that there are frequent references to Bhūikamma or Bhūtikarman, Kautuka, Mangala, Prāyaścitta, Balikarma and Rakṣāvidhāna, in the canon. Bhūtikarma is besmearing the body or an object with ashes or earth or tying to it an amulet, charm or thread accompanied with recital of Mantras for protection of the person or the object against evil eye, evil influence, evil spirits or even illness and theft. Rakṣāpoṭṭalikā used to be tied by Dikkumarīs (female deities) to the wrist of a newly born Tīrthaṅkara as protection against evil spirits and evil eye.

Balikarma is worship of or oblation to household deities. Rakṣāvidhāna is a protective rite. Kautuka is putting a mark with ashes, soot or black pigment on the forehead, with the object of warding off evil. Mangala means auspicious objects like curds, unhusked rice Dūrvā grass and Siddhārtha i.e. Sarṣapa or white mustard and Prāyaścitta means expiatory or propitiatory rites toward off apprehended evil indicated by bad dreams or movement or transit of planets. See Bṛhatkalpa bhāṣya I, 1308 ff. Sūtrakṛtāṅga II, 2, 32; Bhagavatī Sūtra IX, 33, Sūtra 380; Uttarādhyayana XXII, 9; Aupapātikasūtra II & 27; Jambudvīpapannatti V, Sutra 114; Jnātādharmakathā I, 1 Sūtras 12 & 14 and I, 14 Sūtra 99; Vipākasūtra I, Sūtra, 28 p. 77; Praśnavyākaraṇa I, 2 Sūtra

7; Rājaprasnīya, Sūtra 54 p. 120; Vyavahārasūtra Sutra I; Kalpasūtra III, Sūtra 67 p. 62; Upāsakadaśāṅga, I Sūtra 3 & VII, Sūtra 43, Āvaśyaka -bṛhadvṛtti p. 518 and Pancāśaka XIII, 24.

Obtaining answers by questioning seers, who know future by gazing on a piece of cloth, mirror or crystal, sword, water, or wall aided by deities, or through Vidyās giving answers in dreams, or through a deity like Ghaṅṭika Yakṣa communicating the answer to the ear of a Dombī—is also classed with the above along with Nimitta or Divination in Bṛhatakālpa I, v. 1314 which says that one employing these through pride is tainted with 'Ābhiyogika' Karma which makes him subservient to other deities in the next life but if one employs these without any desire for personal benefit and only for enhancing the credit or reputation of the Jain fold and the Jain faith he becomes an 'Ārādhaka' or faithful devotee and earns Karma which would make him high-born in the next life. +

We would stop here for a moment to show how this is a complete answer to all objections against Mantras and Vidyās and an explanation of what is really meant by inclusion of Mantras and Vidyās in Pāpa-śruta. * It means that by themselves they are not sinful but it is their abuse that makes them so and that they are called Pāpaśruta only because of such possibility of their abuse; otherwise the fact that

+ Cf. Bhagavatīśūtra III, 5; Uttarādhyayana XXXVI, v. 262 p. 709. See Thāṅga IV, 4, 354 p. 274 for 5 Bhāvanās.

* Besides Sūtrakṛtāṅga II, 2, Sūtra 30 already referred to Thāṅga IX,3, Sūtra 678 p. 451, and Samavāyaṅga XXIX p. 49 term Mantras and Vidyās 'Pāpaśrutas'. The last mentions works on Vidyās like Rohiṇī and others, works on Mantras of Ceṭakas and others, and works on Yoga i.e. herbs or powders meant for other's fascination or control. Uttarādhyayana XXXI v. 19 also prohibits employment of Pāpaśruta; strangely the Saṅgrahaṇī verse cited by the commentator does not include Mantras and Vidyās but only Nimitta of eight kinds and sciences of singing, dramaturgy, architecture, medicine and archery and cites a Saṅgrahaṇī verse in support which is also cited at p. 660 Āvaśyaka-sūtra by Śrī Haribhadrasūri in his commentary.

Vidyā is defined as Śrutā comprised in Pūrva would be a direct contradiction as all Purvās are sacred and Vidyā being part thereof is also sacred (See commentary on Vijjācāraṇa Sūtra 683 p. 794 Bhagavatī-sūtra XX). Vidyācāraṇas actually employ Vidyā to enable them to move about in the air. They would not have done so if such use of Vidyās had been prohibited or considered sinful. Śrī Vajraswāmi an ideal Āchārya also used Vidyās (See his life described ante). *

Had there been anything objectionable in Mantras and Vidyās *per se* the person employing the same properly would not have been considered an Ārādhaka. Not only that but as we shall show further on a Māntrika failing to employ Mantra on a suitable occasion is termed a Virādhaka or an offender against Faith. Of the triple essentials namely Darśana-faith, Jñāna-knowledge and Cāritra-conduct Māntric Sādhanā and Mantra-prayoga involve slight transgression against conduct only which can be atoned for by expiatory rite as is performed by a Sādhu after even careful movement for necessities of life of an ascetic. That would be the case if there is no abuse of Vidyās and Mantras; otherwise it might be an offence against all the three essentials including the prime essential-faith. * The Jains ordinarily recognise Mantras and Vidyās for peace and tranquility of body mind and soul. See the following Sūtra which is a part of Pratikramaṇa i. e. confession and repentance ceremony daily performed by the Jains wherein deities devoted to the service of the Jain fold are invoked for the peace and tranquility of the body mind and soul:—

वेयावच्चगराणं संतिगराणं सम्मदिहिसमाहिगराणं करेमि काउस्सगं ।

* Uttarādhyayana XXXVI v. 262 elucidates the point, also Thaṇṅga IV, 4 sūtra 354.

* Bhagavatisūtra III, Udd. 4 to 6 dealing with projection of forms and things through Vaikriya Labdhi include a passage in Udd. 5 question 18 and 19 and answers thereto which says that a person employs miraculous power only because of Kaṣāya (anger, pride, deceit and covetiveness otherwise termed Rāga-attachment and Dveṣa-aversion) affecting him and that therefore confession and repentance are necessary. This would apply equally to employment of Vidyās and Mantras.

REFERENCES TO VIDYĀS AND MANTRAS FROM SCRIPTURES

Jain scriptures while giving rules as to how a Sādhu should obtain his food by begging state that he should not in obtaining food commit any of the sixteen faults including employment of Vidyā, Mantra, Cūrṇa or magical powder and Yoga—a mixture of drugs or Mūla i. e., roots or herbs meant for a charm:

धाई इइ निमित्ते भाजीव वणीमगे तिगिच्छा य ।

कोहे माणे माया लोभे य हवन्ति दस एए ॥

पुठिं पच्छा संथव विजा मंते य चुन्न जोगे य ।

उप्पायणाइ दोसा सोलसमे मूल कम्मे य ॥—पिण्डनिर्युक्ति, ४०८, ४०९

ĀCĀRĀṄGA AND UTTARĀDHYAYANA

Besides Piṇḍaniryukti, commentary on Ācārāṅga II, 1 Sūtra 273 and commentary on Ṭhāṇāṅga III, 4 Sūtra 196 also describe the said sixteen faults. Similarly Uttarādhyayana XV, vv. 7 & 8 say that he is a Sādhu who does not maintain himself by employment of Vidyā, Mantra and medicine and gives them up. Uttarādhyayana XXIV vv. 21-25 while describing eight essentials for observance of Sādhus called 'Pravacanamāṭṛs' and particularly the three 'Guptis' say that a Sādhu should carefully control himself from a resolve involving injury to others and execution thereof through concentration or recital of Mantras. Similarly Uttarādhyayana XVIII, 31 says that a Sādhu should turn back from divination through questioning deities etc. and from employment of Mantras for fulfilling desires of others.

There is a reference to Omkāra in Uttarādhyayana XXV, 29. Uttarādhyayana-Niryukti v.88 refers to Aṅgavidyā and v.118 to Prāsādapātana Vidyā i. e. Vidyā which brings down a palace. Commentary on Uttarādhyayana VI, p. 263 describes Kāmaghaṭa i. e. a wish-granting pot obtained through Vidyā.

THANĀṄGA

Ṭhāṇāṅga V, 2, Sūtra 440 mentions Rddhi-Labdhi i. e. miraculous powers acquired by development of the soul, and the commentary thereon describes some of the principal ones. Ṭhāṇāṅga V, 3, Sūtra 449 men-

tions five kinds of purifications which include Māntric purification through *Sucividyā*. * *Ṭhāṇāṅga IX, 3, Sūtra 692* mentions Ambada who was a *Vidyādhara* and a Jain layman in the time of *Śrī Mahāvīra*. *Ṭhāṇāṅga X, 3, 755*, mentions the miraculous works described at p. 151 ante; and *Sūtra 776* mentions *Tejoleśyā* i. e. miraculous power of destruction acquired by performance of austerities which could burn a person to death or consume any object. *Śītalesyā* is a counter to the said *Tejoleśyā* and extinguishes the fire generated by the latter. *Śrī Mahāvīraswāmi* employed *Śītalesyā* to protect his pupil *Gośāla* from being burnt to death by an ascetic named *Vesiyāyaṇa* through *Tejoleśyā* directed against *Gośāla*. See for the said account *Bhagavatisūtra XV, Uddeśa 1, Sūtras 543, Āvaśyakacūrṇi pp. 298–299* and *Triṣaṣṭhiśalākāpuruṣacaritra IV, vv. 117–119*. *Śrī Gautamaswāmi* went up *Mt. Aṣṭāpada* by use of miraculous power viz. *Janghācāraṇa-labdhi* to make obeisance to the images of the twenty-four *Tīrthaṅkaras* in the temple constructed there by *Śrī Bharata*, the eldest son of *Śrī Rṣabhadeva*—See *Āvaśyakacūrṇi p. 383*, and *Āvaśyaka Brāhat-tikā p. 287*. The reader would see from these accounts that there is no absolute prohibition against the use of miraculous powers.

SAMAVĀYĀṅGA RĀYAPASEṆĪ AND JAMBUDVĪPAPRAJNĀPTI

Samavāyāṅga LXXII, p. 83 mentions seventy two arts for man which include *Vidyā* and *Mantra* as the 47th and 48th arts. The names of the 45th and 46th arts are the names of two *Vidyās* mentioned in *Sūtrakṛtāṅga II, 2, Sūtra 30* described ante. *Rājaprasnīya, Sūtra 83* describes them differently; commentary on *Jambudvīpaprājñapti II, Sūtra 30* reproduces the 72 arts from *Rājaprasnīya* but gives independently 64 arts for woman which include *Mantra* and *Tantra* as the 4th and 5th arts. As these seventy two or sixty four arts were expected to be acquired by everybody i. e. all house-holders who desired to be classed amongst the learned according to the standard prevalent in former

* *Sucividyā* is described at p. 14 B of *Nirvāṇakalikā*.

times, it shows that the generality of people used to be versed in Vidyās and Mantras in those times.

BHAGAVATĪSŪTRA, JNĀTĀDHARMAKATHĀŅGA, ANTAKṚTDAŚĀŅGA,
VIPĀKA & UVAVĀI

At Page 149 ante we have given a reference to Rāyapaseṇi, Sūtra 53 which describes Srī Keṣi Kumaraśramaṇa as being prominent in the knowledge of Vidyās and Mantras (विज्जप्पहाणे मंतप्पहाणे). Similarly at p. 174 ante we have stated that according to a set description all Gaṇadharas are said to be Mantrapradhāna and Vidyāpradhāna. We would cite Jnātādharmakathā I, 1, Sūtra 4 and Vipākasūtra I, 1 Sūtra 1 where Ārya Sudharma is so described. We have also referred to p. 32, Aupapātika Sūtra where “Therās” are also similarly described. Bhagavatīsūtra 5, Sutra 108 has a similar description of ‘Therās’ of Srī Parśvanātha. These descriptions conclusively show how the Jain canon views Vidyās and Mantras. It would not have so described—as it has done—Gaṇadharas and Therās, if it considered Vidyās and Mantras had something inherently sinful or derogatory, because in that case such description would not in anyway redound to their credit or properly represent the very high qualities acquired by living ideal ascetic life by these persons. As the said attributes are in juxtaposition with others describing the very high and rare qualities of Gaṇadharas and Therās the said attributes also must be taken to describe their very high and rare qualities—not merely approved of but greatly acclaimed. Jnātādharmakathā I, 14, Sūtra 99 mentions inter alia Cūrṇayoga and Mantrayoga. The said passage throws considerable light on the condition of society in ancient times as it was commonly believed that ascetics were possessed of miraculous powers or had knowledge of Mantras or charm with ashes, clay or thread, magical powders or herbs, roots, bark, creeper, or a blade of Silika grass, pills, medicine or combination of medicines which would cause enchantment, fascination or bring good luck or prosperity to a person. Suvratā the Jain female ascetic, says that she would not even hear such things,

much less instruct anyone to employ same. As mentioned in the footnote on p. 175 ante Antakṛddasāṅga III 8, Sūtra 6 mentions worship of the image of Śrī Hariṇegameṣi.

PRAŚNAVYĀKARAṆA

Praśnāvyākaraṇa 1, 1 Sūtra 7 (p. 28 et seq.) is a long Sūtra and contains several references to Mantras important for our purposes. There are the following references:—'Yantras' meaning 'Diagrams' for the purpose of driving away the opponent etc; 'Āhevaṇa' meaning 'Attracting people' and according to a variant reading 'Ahivvaṇa' meaning 'Rendering inimical', 'Āvindhana' meaning making 'one possessed', 'Ābhiyogya' meaning 'making one subservient'—all this being done through Mantras or medicine. Further the Sūtra refers to 'controlling' which destroys the mental power or will of the medium. These, though true in form, involve injury to living beings, so are, in spirit, untrue; and those who teach these to others are condemned. It includes taking or giving bath with charmed waters for prosperity, good luck etc., protective magical rites, as also Śāntikarma i. e. oblation to fire for obtaining peace or good health accompanied with recitation of Mantras. This shows widespread prevalence of Mantras and Māntric rites.

Praśnavyākaraṇa II, 2, Sūtra 24 (pp. 113–114) praises 'Truth'. Truth is said inter alia to contribute to accomplishment in the flying—lore of Vidyādhara and Cāraṇas (flying—ascetics) as also Mantras, Medicine and Vidyās. It also says all Mantras, Magical powders, recitation of Mantras, Vidyās* and Jambhagas (i. e. the deities concerned with Mantras, Vidyās and Wealth), Economics, weapons, Arts and Scriptures have truth as their base.

VIPĀKAŚRUTA

The last of the 11 existing Aṅgas is Vipākaśruta. Its II Śrutaskandha, Sūtra 4 (p. 54) narrates the story of one Priyasena who would control the king, lords and others by employing Vidyās and magical

* Mantras as of Śrī Hariṇegameṣi and Vidyās such as Prajñapti and others.

powders for fascination or being invisible or charming, controlling or making others subservient. This does not require further comment.

UPĀNGAS

Coming to the Upāngas besides the references already given Uvavaī p. 28 refers to Śrī Mahāvīra's Sādhus possessed of various miraculous powders (Labdhis) including Cāraṇas which according to the Commentary means Janghācāraṇas and Vidyācāraṇas (Sādhus possessing miraculous powers through austerity and Vidyā enabling them to fly through the air),—see Bhagavatī XX, 9, Sūtra 683 p.793 and commentary thereon p. 794. Vijjāharas (persons accomplished in special Vidyās like Prajnapti and others), and Āgāsātivāino (persons capable of bringing down from the sky in form of rain desirable objects like gold etc. and also undesirable objects like dust, pebbles etc). Rāyapaseṇi Sūtra 80 inter alia refers to Mantraprayoga thought of by queen Sūriyakantā to kill king Paesī. Pupfiyā–Puṣpikā IV (p. 31 A) refers to Vidyā–prayoga and Mantraprayoga for getting issue.

DAŚAVAİKĀLIKA AND PRABHĀVAKAS

Amongst Mūlasutras Daśavaikālika Adh. II, v. 6 mentions 'Agandhana' snakes who would not suck up again poison from the part of the body bitten by them once they have emitted it and would prefer to be burnt to death under Māntric compulsion. The other kind of snakes called 'Gandhana' are the common snakes who when forcibly drawn back by Mantras suck up the poison from the bite being compelled to do so by Māntrikas. Daśavaikālika Adh. VIII, 2, 51 says that a Sādhu should not communicate inter alia Mantra or Medicine or magical powder or the science of divination or dreams or astrology as the same involves injury to living beings. This presumes knowledge of Mantra etc. on the part of the Sādhu. Commentary p. 41 et seq. Daśavaikālika I mentions Avanāminī and Unnāminī Vidyās (the former brings down objects and things and the latter raises them up) possessed by a Mātaṅga *

* Quoted by Malayagiri in his commentary on Vyavahārasūtra, Pīthikā, p. 28. See also Niśītha Bhāṣya, Pīthikā v. 33 (p. 20) which is the same with a variant reading.

(a member of the depressed class) and acquired from him by king Sreṇika. Commentary p. 58 Daśavaikālika Adh. I mentions invocation of a deity through Vidyā for inducement of faith in a pupil and commentary p. 40 mentions reaching destination over a long route quickly through Vidyā. The following v. 183 of Daśavaikālika-Niryukti (p. 101) mentions eight kinds of persons who through their respective qualities add to the glory of the Faith. They are (1) persons possessing supersensual knowledge (2) or Miraculous power 'Labdhi' (3) Ācharyas (4) Dialecticians (5) Excellent exponents of religion (6) Ascetics performing severe austerities (7) Diviners (8) Persons accomplished in Vidyā and persons respected by the Royalty or the people.

‘अइसेस इडुयायरिय वाइ धम्मकही खमग नेमिली ।
विजजारायगणसंमया य तित्थं पभाविंति ॥’ १८३

‘PRABHĀVAKAS’

We give below a verse usually cited to describe eight kinds of persons who add to the glory of the Jain faith.

“पावयणो १ धम्मकही २ वाई ३ नेमित्तिओ ४ तवस्सी य ५ ।
विज्जा ६ सिद्धो य ७ कई ८ अट्टेव पभावगा भणिया ॥”

‘Eight kinds of persons are said to add to the glory of the Jain faith and they are (1) Exponent of religion (2) Exponent of religion through stories (3) Dialectician (4) Diviner (5) Ascetics performing severe austerities (6) Person accomplished in Vidyā (7) Person accomplished in Mantras, magical powders, root and herbs (8) and Poet.’

The readers would note that persons accomplished in Vidyās and Mantras are recognised as Prabhāvakas (adding to the glory) of the Religion. It would not have been so if Mantras and Vidyās were considered inherently sinful or if there was absolute prohibition against their employment. Āvaśyaka Sūtra and its Cūrni and Bṛhat-tikā by Śrī Haribhadrasūri have numerous references to Mantras, Vidyās, Māntrikas, Vidyādharas, Siddhas and allied subjects. We would comment only on the important amongst them. The same remarks apply

to two of the Six Chedasūtras viz: Vyavhāra Sūtra and Bṛhat-Kalpa, their respective Bhāṣyas and commentaries.

ĀVAŚYAKASŪTRA

Āvaśyaka-Niryukti v. 927 mentions eleven kinds of Siddhas including Vidyāsiddha, Mantrasiddha and Yogasiddha; and the following verses give their illustrations (See Cūrni p. 539 ff. & Bṛhattīkā p. 408 ff.). Niryukti v. 931 defines and distinguishes between Vidyā and Mantra as mentioned in the note* on p. 147 ante. Niryukti v. 932 says that the universal monarch of Vidyās is he who is accomplished in Vidyās or at least one Mahāvidyā like Mahāpuruṣadattā as was Āryakhapuṭācārya. The commentary thereon says that Vidyās are accomplished even by obeisance to a Vidyāsiddha. Niryukti v. 933 says that he is accomplished in Mantras who has mastered all Mantras or many Mantras or even a single principal Mantra as was the Sādhu who through Mantra pulled out and drew away through the air the columns from the front of a palace-gate. Niryukti v. 934 says that he is a Yogasiddha who is fully acquainted with all the mixtures of magical powders of miraculous effect or even one of them as was Ārya Samita. (See note* p. 191 ante). At p. 452 there is an interesting account of Sādhanā with a dead body and the miraculous effect of Pañcaparameṣṭi Mantra which protected the boy meant to be sacrificed to the Vetāla by an ascetic who was seeking Siddhi as to Suvarṇa Puruṣa i. e. gold-man. At p. 407 obeisance to Arihanta is said to be the meaning of twelve Aṅgas, as all the Aṅgas are meant for purification of thought which is achieved by such obeisance also. Bṛhat-tīkā p. 392 mentions Paraśu Vidyā acquired by Paraśurāma and p. 401 describes 'Cāṇḍālas' who were Vidyāsiddhas. Bṛhat-tīkā p. 812 mentions a compromise effected between a person who had recently embraced Jainism and one of the deities previously worshipped by him, where by the layman agreed to worship the deity on account of insistence by the latter if the deity agreed to remain by the side of the images of Jinas. This shows that as long as a person worships Tīrthaṅkara as the only divinity who

could lead him on the path to Salvation, he would not be committing an offence against Faith if he worshipped a deity either subsidiary to or attendant on Jinas for some worldly object or only out of compulsion.

The story of Gandharva Nāgdatta p. 65 ff. Cūrṇi and p. 565 ff. Bṛhat-tīkā, Āvaśyaka Sūtra shows the prevalence of snake-charming and curing persons bitten by snakes through Mantras in ancient times. It was otherwise known as Gāruda Vidyā. The persons accomplished in it were styled Gandharvas, perhaps because snakes are charmed by Mantras to the accompaniment of music. P. 605 Bṛhat-tīkā cites the following verses from Dhyānaśataka of the famous gloss-writer Jinabhadragaṇi Kṣamāśramaṇa wherein the removal of poison from the body of a person bitten by a snake through Mantras is given as an illustration of how soul is freed from the poisonous brooding of the mind by Śrī Jina.

अहसम्बसरीरगयं मतेण विसं निरुंभए डंके ।

ततो पुणोऽवणिज्जइ पहाणयरमंतजोगेण ॥

तह तिहुयणविसयं मणोविसं जोगमंतबलजुत्तो ।

परमाणुमि निरुंभइ अवणेइ तओवि जिणवेज्जो ॥ ध्यानशतकं, श्लो. ७१-७२

Niryukti vs. 220, 227 & 228 state that 'Kautuka' through application of ashes, science of divination and obtaining answers by questioning Iṅkhiṅikā-Dombī (who ties small bells to her ears and jingles them when Ghaṅṅika Yakṣa whispers in her ears the answer to her question which she communicates to the person consulting her) arose in the time of Śrī Ṛṣabha. Niryukti v. 508 mentions Mahābhūtika Indrajālika i. e., one who is able to create hallucinations. Niryukti v. 218 says that Pūjā-worship of Nāgas and others arose in the time of the universal monarch Bharata, son of the first Tirthaṅkara Śrī Ṛṣabhadeva. Utsava-celebration in honour of Indra also arose in his time.

PIṆḌANIRYUKTI

Another Mūlasūtra, Piṇḍaniryukti has several references to Vidyā, Mantra, Cūrṇa, Yoga and Añjana besides the one already cited above. V. 52 p. 21 refers to consultation with a deity for divination by an

ascetic who is constantly attended upon by deities pleased with him because of his severe austerities. V. 462 (p. 133) refers to miraculous powers obtained inter alia through Vidyā such as driving away or killing an opponent. V. 465 (P. 134) refers to 'Labdhi' (miraculous power obtained through development of soul). Piṇdaniryukti vv. 494–500 and Bhāṣya v. 44 refer to Vidyā, Mantra, Cūrṇa, Añjana and Yoga.

They mention as illustrations of their employment a Sādhu who obtained rich food from a very miserly and mean person through previous enchantment of his house; Pādaliptasūri who cured King Muṛuṇḍa of severe headache by moving his index–finger round his own knee accompanied with mental recitation of Mantra; two young sādhus who became invisible by application of magical collyrium to their eyes and who used to dine with King Chandragupta unknown to him, but were discovered by Cāṇakya; and Ārya Samitasuri (see note p. 191 ante) who through mixture of magical powders divided the waters of the river Benā and crossed over to the opposite bank. The said passage also describes the evils likely to follow from the employment of Vidyā or Mantra viz. that the opponent might employ counter–Vidyā or Mantra and might paralyse, drive away or kill the person who first used Mantra or Vidyā; or there may be a scandal amongst the people that the person employing Vidyā or Mantra is deceitful and lives sinfully, harming others, and might be arrested, tortured, made to give up the dress of Sādhu or might be capitally punished on a complaint being made to the Government that he is a magician injuring others through magical practices. Piṇdaniryukti v. 499 states that there might be an exception in the case of a properly qualified person; Āchārya Malayagiri in his commentary thereon says that such a person should employ Mantra for the sake of the Jain fold. * This makes it quite clear that the Jain scriptures although prohibiting employment of Mantras and Vidyās generally recognise an exception and recommend employment of Mantras and Vidyās by a properly qualified person for the sake of the Saṅgha.

* “सङ्घादिप्रयोजने मन्त्रोऽपि प्रयोक्तव्य इति भावार्थः ।”

VYAVAHĀRA SŪTRA

Bhāṣya v. 118 of Vyavahāra-Pīṭhikā (p. 41) prescribes contemplation through Pañcamaṅgala i. e. Pañcaparameṣṭi Mantra in case of any ill-omen. Vyavahāra I, Bhāṣya v. 82 (p. 74) says that a Sādhu may stay on with another who is possessed of Vidyā or Nimitta till he learns the same from him. Commentary on Bhāṣya I, v. 90 (p. 76) says that as a rule one should not enter into a controversy with a powerful king. If he, however, persists he should be controlled through Vidyā Cūrṇa etc. Bhāṣya I, (p. 84) vv. 130 and 131 recommend that a debater about to enter into a debate should be inter alia taught Vidyās which are counter to those of his opponent. Vyavahāra Bhāṣya I, p. 121 says that a Sādhu possessed of Labdhi or Vidyā should bring round an inimical king through Labdhi, Vidyā or Mantra. Vyavahāra Bhāṣya I, p. 137 says that one desiring to confess and repent should resort to Koraṅṭaka garden in Broach and invoke the presiding deity observing a three day's fast and carry out expiatory austerities as might be prescribed by the deity.

Vyavahāra Bhāṣya III v. 181 et seq. refer to the case of a Sādhu who becomes distracted having been charmed through Vidyā, Mantra or magical powder and prescribe that if he cannot be cured of such fascination by persuasion of the person employing the same, counter-Vidyā should be employed to remove such fascination and engender repugnance instead in the mind of such person towards the Sādhu. As an example is mentioned the austere Sādhu who through his miraculous powers protected a Jain female ascetic from the clutches of the Buddhists. Bhāṣya II, v. 185 throws abundant light on the propriety of employment of Mantras in such cases * and v. 191 says that a Sādhu should be protected from his opponent through persuasion or threats or by employment of such miraculous power as one possesses;

* विसस्स विसमेवेह उसहं भग्गिमग्गिणो ।

मंतस्स पडिमंतो उ दुज्जणस्स विवज्जणा ॥१८५॥

how can one neglect one's adherents although he has power to protect them.

अणुसासण भेसण या जा लद्धी तस्स तं न हावेज्जा ।

किं वा मति सत्तीए होइ सपक्खे उवेक्खाए ॥१९१॥

If a Sādhu who had been a slave is claimed back by his master Vyavahāra Bhāṣya II, v. 220 prescribes that Vidyās or Mantras should be employed to secure his freedom.

Vyavahāra Sūtra Bhāṣya IV, v. 12 states inter alia that Vidyās have to be repeated and Prābhṛtas and Nimitta are to be studied in a solitary place; Āchārya and Upādhyāya may do so going elsewhere. Vyavahāra Bhāṣya IV, v. 339 refers to Sūtra commencing with Namukkāra, i. e. Pancaparamēṣṭi Mantra. Vyavahāra Bhāṣya V, v. 18 refers to Vidyā, Mantra, Cūrṇa Nimitta and astrology. Vyavahāra Bhāṣya V, v. 121 etseq. state that an Āchārya must acquire Vidyā Mantra etc. to remedy serpent-bites. V. 136 describes various Vidyās such as 'Dūta' where the messenger or representative is treated instead of the person who is ill and the latter is cured; 'Ādarśa' in which the reflection in a mirror is magically treated and the person who is reflected is cured; 'Vastra' in which with a piece of cloth over which Mantra is recited passes are made over the body of the affected person and he is cured; 'Darbha' in which a blade of grass is so used; 'Tālavṛnta' in which a palmyra fan is so used, and the affected person is cured; 'Capetā' in which someone is slapped and the affected person is cured; and 'Antahpura' or harem in which passes are made over one's own body instead of that of the affected person and the latter is cured. Bhāṣya V, vv. 139-140 say that a female ascetic may recite Mantra but not Vidyās unless it has been previously acquired by her i. e. before initiation.

Vyavahāra Bhāṣya VI, v., 148 says that an Āchārya must be protected lest a woman should cast a spell upon him or bring him under her control. Vyavahāra Bhāṣya VI, v. 154 says that an Āchārya has to recite Vidyās and Mantras and study sciences dealing with Nimitta and Yoga in a solitary place, so he should not go out to beg food.

If there be any doubt still lingering in the minds of the readers as to Sādhanā or practice of Vidyās and Mantras by Jain Sādhus it should be thoroughly dispelled by vv. 251–252, Vyavahārasūtra Bhāṣya VI, which say: 'Āchāryas repeat Vidyās on every 'Parva' i. e. the middle day of the month or the fortnight. The middle day of the fortnight i. e. the eighth day is considered 'Parva,' so also the middle day of the month, i. e. the fourteenth day of the dark half (of the month); other 'Parvas' being the days of the eclipse of the sun and the moon.' *

Siddhaputras and Siddhaputrīs are referred to at various places as also Sārūpikas in Vyavahārasūtra–Bhāṣya, (See Udd. IV v. 134 ff; Udd. V v. 74 Udd. VII vv. 13, 17; Udd. VIII v. 288). Nimitta, Vidyā, Mantra, Cūrṇa and Yoga are referred to in v. 3 Udd. VII. V. 187 * Udd. VII uses as an illustration the fact that whatever the universal monarch of Vidyā utters becomes Vidyā, but that it is accomplished at the proper time and place; so the utterances of Jina which are possessed of eight qualities should be recited with due regard to time and place and not indiscriminately at all times and at all places. V. 201 Udd. VIII refers to 'Abhiyoga' superior force i. e. charming or controlling. Sūtra 8, Udd. X, p. 97 and the Bhāṣya thereon respectively refer to and explain 'Gaṇasobhī'. i. e. one who adorns the fold. It says: 'A dialectician as mentioned in the 1st Uddeśa, an exponent of the religion through appropriate stories, a diviner and one possessing miraculous powers through Vidyā adorn the fold.'

NIŚĪTHA SŪTRA

Niśītha Sutra XIII Uddeśa is full of references to Kautuka

* विज्जाणं परिवाही पव्वे पव्वे य देति आयरिया ।

मासद्धमासियाणं पव्वं पुण होइ मज्झं तु ॥२५१॥

पक्खस्स भठमी खलु मासस्स य पक्खिअं भुणेयव्वं ।

अण्णं पि होइ पव्वं उव्वरागो चंदसूराणं ॥२५२॥

× जहा विज्जा नरिदस्स जं किंविदपि भासियं ।

विज्जा भवति सा चेह देसे काले च सिज्झइ ॥१८७॥

etc., Nimitta, dream, Vidyā, Mantra, Yoga and Cūrna and says that if they are employed for or communicated to the followers of other religions or even to Jain householders, the Sādhu so doing shall perform penance as therein prescribed. It is apparent from this that he does not commit any sin if the same are employed for or communicated to Jain Sādhus. We are however not left to gather the meaning in such an indirect manner for Bhāṣya verse 4284 and the Cūrni thereon (p. 841 s. y. 1996 Edn.) state the exceptions clearly: one should in exceptional circumstances employ Kautuka etc. or communicate Mantra. The exceptional circumstances are specified to be epidemic, famine, kingly oppression, fear, illness, blockade of roads, necessity to ascertain the cause of any strange happening, debate, or for adding to the glory of the faith. ×

Niśītha Pīthikā (pp. 8–9) refers to Mātaṅga Harikeśa who was accomplished in Avanāminī and Unnāminī Vidyās and illustrates how humility and respect for the Guru are necessary in a Sādhaka for acquiring accomplishment in Vidyās. Niśītha Uddeśa I, Bhāṣya v. 410 (see Cūrni thereon p. 125) states that for the purpose of acquiring Vidyās a Sādhu may cultivate friendly relations with a householder or a lax Sādhu (Pāsaththa). Niśītha Uddeśa XVI, Bhāṣya v. 63 refers to Ratnadevatā, Śuci-Vidyās and Mātaṅga Vidyās named Gaurī and Gāndhārī; compare Bṛhatkalpa Bhāṣya Udd. I, v. 2508. Niśītha Uddeśa XVI Bhāṣya v. 472 says that one may adopt another Āchārya as a preceptor for acquiring Vidyā Mantra and Nimitta and it would be deemed to be done for enhancing the glory of the Faith. +

The most important reference however is at p. 1105 Niśītha-cūrni Uddeśa XVI, Bhāṣya v. 571 which states that in case Sādhus get accidentally lost in a dense jungle and are unable to find their

× असिन्वे ओमयरिए, रायदुद्रे भए व गेलण्णे ।

अद्धानरोहकज्जेऽट्टजा य वादी पभावणता ॥ भा० ४२८४ ॥

+ Cf. Bṛhatkalpa Udd. V. Bhāṣya v. 5473.

way to an inhabited quarter, they should resort to contemplation of the sylvan deity (who may be attached to the Jain Faith), assuming Kāyotsarga pose. The deity thus invoked would tell them the way to an inhabited place or guide them there through some miracle such as the appearance of an illusory herd of cows in some part of the forest going to such a place. The significance of the said reference is that the Jain sacred scriptures under special circumstances sanction invocation of such deities by Sādhus for such and similar purposes, just as Vyavhārasūtrā Udd. X p. 137 sanctions invocation of the deity presiding over Koraṇṭaka at Broach for ascertaining appropriate expiatory austerities for due performance of Repentence.‡

MAHĀNISĪTHA

Adh. III Udd. 11 gives Vardhamānavidyā alias. Aparājitā Mahāvidyā. It is also given at the end of Adh. VIII after the colophon. Srutadevatā Vidyā is set forth in Adh. 1 v. 46ff. It is to be recited one lac times in a temple. These are known as two Mahānisītha Vidyās. Adh. VII Uddeśā 4, Āryā verses 19–20 give Kurukullā Mantra: 'ॐ कुरुकुले स्वाहा' * for protection against all kinds of dangers (vv. 19–23).

BRĤATKALPA SŪTRA

Commentary on Bṛhat Kalpa Pīthikā Bhāṣya v. 20 states that just as Vidyā and Mantra are acquired by worship with due regard to material, place, time and devotional feeling so Maṅgala or Benedictory verse comprising a prayer in the beginning of a work brings about completion thereof without obstacle and confers the desired fruit on the pupils studying the work.

‡ Cf. Bṛhatkalpa Bhāṣya Udd. I. vv. 3104 to 3110 and also the writer's article entitled 'Place of Mantra, Vidyā and Tantra in Jainism' Jain Yuga Vol. V, 1–3 pp. 53–56.

* Kurukullā is referred to in such an ancient work as Rudrayāmala at p. 92 "ॐ कुमारी कौशिकी काली कुरुकुला कुलेश्वरी ।" as in Mahānisītha. It will not therefore be correct to say that Kurukullā is a Buddhistic deity borrowed by other pantheons.

Pīthikā Bhāṣya v. 146 refers to miraculous works which the commentary interprets as Mahāparijñā, Aruṇopapāta etc. Pīthikā Bhāṣya v. 291 mentions the incident of a Vidyādhara invoking a Vidyā of which a word or two were forgotten by him and how Prince Abhaya by his 'Padānusāri' power supplied the same and acquired from the Vidyādhara the Vidyā in return. Bhāṣya I, v. 1009 mentions as an illustration Sādhanā of Vetāla and its dangers when not properly performed. Bhāṣya I vv. 1308-1314 we have already referred to as describing Kautuka, Bhūtikarma etc. and showing how and when a person employing the same as well as Vidyā and Mantra become 'Ārādhaka' and acquires Karma which would make him high-born in the next life.

GHANTIKA YAKṢA AND GHANTĀKARṆA

Bhāṣya I, v. 1312 (pp. 403-404) refers to Ghaṇṭika Yakṣa who may probably be the same as Vīra Ghaṇṭākaraṇa. The Mantra of Ghaṇṭākaraṇa‡ styled Ghaṇṭādi Vidyā is given after vv. 10-12 Ch. VI, Vidyānusāsana and also in the commentary on v. 1 of Namiuṇa Stava. + As some are under the erroneous impression that Ghaṇṭākaraṇa is a Buddhist deity we may note that Agni-Purāṇa Adh. 50 vv. 41-42* describe his Dhyāna with eighteen arms. He is therein described as destroyer of diseases and particularly Visfoṭaka-tumours or small-pox as is mentioned in his famous Mantra. The ancient lexicographer and

‡ ॐ घंटाकर्ण महावीर सर्वभूतहिते रतः ।

उपसर्गभयं घोरं रक्षरक्ष महाबल स्वाहा ॥

+ ॐ घंटाकर्ण महावीर सर्वव्याधिविनाशक ।

विस्फोटकभये प्राप्ते रक्षरक्ष महाबल स्वाहा ॥

* घण्टाकर्णोऽष्टादशदोः पापरोगं विदारयन् ।

वज्रासिदण्डचक्रेषुमुसलाङ्कुशमुद्गरान् ॥४१॥

दक्षिणे तर्जनीखेटं शक्तिं मुण्डं च पाशकम् ।

चापं घण्टाङ्कुठारं च द्वाभ्यां चैव त्रिशूलकम् ।

घण्टानालाकुलो देवो विस्फोटकविमर्दनः ॥४२॥ अग्निपुराण, अ० ५० ।

grammarian Vyādi, a contemporary of Pāṇini . (circa 350 B. C.) according to Kathāsaritsāgara, IV Taranga, but who flourished certainly before Kātyāyana mentions Ghaṇṭākarna as a 'Gaṇa' of Śiva:

“ गोपालो ग्रामणीमालुर्घटाकर्णकरन्धमौ ”.

See Svopajnatīkā on v. 124 Abhidhānacintāmaṇi II, P. 89. Skandapurāṇa, Kāśīkhaṇḍa, Uttarārdha, Adh. 53, v. 8 and vv. 30 to 43 (p. 232) also mention Ghaṇṭākarna as a 'Gaṇa' of Śiva. Harivaṃśa Bhaṣya Adhs. 79 to 83 refer to Ghaṇṭākarna and his meeting Śrī Kṛṣṇa in Badarikāśrama and his worship of Viṣṇu.

Yoginī Tantra (p. 461) v. 101† also mentions Ghaṇṭākarna as one of the Viras. Jinaprabhasūri refers in his Vividha-Tīrtha-Kalpa (p. 86) to a shrine of Ghaṇṭākarna Mahāvīra on Śrī Parvata really referring to the last Tīrthaṅkara Mahāvīra. It may be of interest to note that outside the main temple of the famous Śrī Badarī Narāyaṇa is a small temple wherein an image of Ghaṇṭākarna is even this day found installed.

Bhāṣya I, v. 1318 says that employment of Nimitta i. e. Divination through excess of pride would engender Āsurī Bhāvanā (Demonic mood) which would bring about next birth in the Demon-class of deities. Commentary on Bhāṣya I, v. 2681 mentions creation of horses through the aid of Yoniprābhṛtā by Śrī Siddhasenācārya. Bhāṣya I, v. 2824 refers to Vidyā. Bhāṣya I, vv. 2958–2964 mention employment of Vidyā to ward off danger from beasts of prey, invocation of a deity for the purpose through contemplation by a Sādhu usually performing severe austerities, as also heroic physical self-defence. Besides Gaurī and Gāndhārī Vidyās already referred to (Bhāṣya I, v. 2508) there are references to Prajnapti Vidyā (p. 56), Mohinī and Stambhanī Vidyās (Bhāṣya III, v. 4809, p. 1291; also commentary on Bhāṣya I, v. 2744) and Ābhoginī Vidyā (Bhāṣya III v. 4633, p. 1250).

† एक जङ्घोनलक्षैव कर्दमालिमविग्रहः ।

घण्टाकर्णस्ततोर्द्ध्वं दक्षिणं पार्श्वमास्थिताः ॥१०१॥ योगिनीतन्त्रम् ।

Bhāṣya III, v. 4624 mentions a case in which Mantra or Nimitta may be employed. Bhāṣya III, vv. 4632–4638 mention employment by Sādhus of Vidyās like Ābhoginī, Nimitta and divination in case of theft of things meant for their use. Bhāṣya III v. 4809 mentions employment of Stambhanī and Mohanī Vidyās as also physically dealing out punishment if the Sādhu is able enough through requisite training to do so e. g. to fight a thousand persons simultaneously. Bhāṣya IV. v. 5593 mentions the qualifications of an Āchārya who would depose a king inimical to the Jain fold and amongst such qualifications special mention is made of possession of miraculous powers through Vidyā like Āryakhapuṭācārya. It also mentions Kālakācārya who punished king Gardabhilla. Bhāṣya VI vv. 6270–71 mention protection of the fold through employment of Vidyā, Mantra, Cūrṇa etc. Bhāṣya VI v. 6302 and commentary on vv. 6304 and 6308 mention cases in which Vidyā, Mantra and charmed pills may be used.

PAYANNĀS

In Payannās the reference to Vidyā Mantra Cūrṇa and Nimitta in vv. 798–799 Titthogāli Payanno may be noted. There injury to others through Vidyā etc. is deprecated and is said to entail wandering in unending cycle of births and deaths. The date of Titthogāli Payanno is about the beginning of the 5th century Vikrama era.

Aṅgacūliyā Ms. p. 3 refers in course of the ceremony of initiation to the rite of Vāsakṣepa over which Mantra has been recited by the Āchārya after performance of Digbandhana rite i. e. the rite to ward off undesirable spirits and adverse influence from all quarters. It also refers to Vardhamāna Vidyā. P. 20. refers to false Sādhus who practice astrology, Vidyā, Mantra and Tantra and keep laymen and laywomen pleased through practice of Kārmaṇa, Mohana and Vaśikaraṇa. The concluding portion refers to Vaggacūliā and Vidyā–Mantra–Prayogas therein for Sānti.

POPULARITY OF ŚRĪ PĀRŚVANĀTHA'S WORSHIP

At the commencement of the previous section hereof namely

'Jain Mantravāda and Caityavāsis' we stated how the Māntric literature comprised in the tenth Pūrva, Vidyānupravāda may reasonably be supposed to belong to the age of Śrī Pārśvanātha. Then we stated how he has been invoked in the hymn Uvasaggaharam and described the life led by several Pārśvāpatyās who employed Nimitta involving use of Mantras and Vidyās for obtaining necessities of life and how Māntrikas adopted Śrī Pārśvanātha as the Mantric deity par excellence.* Dharaṇendra, the principal attendant-deity× of Śrī Pārśvanātha is connected with the origin of Vidyās as stated above. Naturally, therefore, Vidyādharas† as well as all Sādhakas of Mantras and Vidyās especially worshipped Śrī Pārśvanātha. 'Purisādāṇīya'—respected by the people—is the title of Śrī Pārśvanātha given in Kalpasūtra which aptly describes his popularity not only during his life but also thereafter. Moreover those Mantras and Vidyās become popular of which the presiding deities are alert and respond quickly. It is believed that the attendant deities of Śrī Pārśvanātha are alert and respond at once when invoked. Further from Jnātādharma-kathāṅga II Śrutaskandha it appears that many of the female ascetic disciples of Śrī Pārśvanātha became on their death the chief queens of Indras of different heavenly regions. All the chief queens of the twenty Indras of Bhuvanapati-deities, of sixteen Indras of Vyantara-deities, of the Moon and the

* After Śrī Bhadrabāhu, Śrī Pādaliptasūri also invoked Śrī Pārśvanātha in a Māntric hymn of 7 verses which is in the writer's collection. We give here the first and the last verses thereof: 'भविकयसंडबोहण, दिणमणिसिरिपासनाहृत्तित्थस्स ।

नामगगहणं वज्जं धरेइ न हु तस्स उवसग्गा ॥१॥

× × ×

इय (मह) सप्पहावेगवीस—मंतक्खरगम्भिय—महाथुत्तं ।

पालित्तथयुयमहियं, विन्नत्तं भवमुक्खकरं ॥७॥

× "विजया जया य कमठो पउमावइ—पासजक्ख वइरुश ।

धरणो विजजादेवी सोलसऽहिद्रायगा जस्स ॥" श्रीपार्श्वनाथ कल्प

+ "आराधितः श्रीऋषभस्य काले विद्याधरेन्द्रेण नमीश्वरेण ।

पूर्वे हि बैताढ्यगिरौ जिनं तं वन्दे सदा शङ्खपुरावतंसम् ॥"

Sun and the Vaimānika Indras Sakra and Īsāna were disciples of Śrī Pārśvanātha in their previous life. Naturally, therefore, when invocation is with the name of Śrī Pārśvanātha these highly placed powerful deities respond promptly and effectively aid and grant the desires of such worshippers. This also accounts for the popularity of the worship of Dharaṇendra and Padmāvati amongst Jains as they are the principal attendant deities of Śrī Pārśvanātha. We may add here that Śrī Pārśvanātha is worshipped at various places under hundreds of different attributes. Some of them are mentioned at p. 86 Vividhatīrthakalpa, line 10 onwards. The several Kalpas of Śrī Pārśvanātha included in Vividhatīrthakalpa also show the popularity of his worship. The connection of Śrī Pārśvanātha with the ancient Jain Stūpa at Mathura also points to the same fact.*

It is significant that Mānadevasūri, the author of the hymn Laghuśānti, although invoking Śrī Śāntinātha, the sixteenth Tīrthaṅkara, for securing peace and tranquility incorporates therein the Mantra of Śrī Pārśvanātha as propounded by Kamaṭha (an attendant deity of Śrī Pārśvanātha) called Mantrādhirāja. Similarly Vādivetāla Śrī Śāntisūri in his hymn named Bṛhat Śānti invokes Śrī Pārśvanātha thus: ॐ स्वाहा । ॐ स्वाहा । ॐ श्रीपार्श्वनाथाय स्वाहा ॥' Similarly in Indranandi's Jvālinīmata (Mantra Kalpa of the attendant deity of the 8th Tīrthaṅkara Śrī Candraprabha), III Adh., vv. 58, 59 it is stated that whatever a Māntrika does, should be in the name of 'Pārśva Jina' and that whatever he utters saying 'Pārśva Jināya' becomes Mantra. This shows with what great regard Māntrikas viewed invocation with the name of 'Śrī Pārśva'. It is therefore unnecessary to dilate further on this point.

ANTIQUITY OF PAÑCAPARAMEṢṬI MANTRA

We shall note below some inscriptional proof as to the antiquity

* Epigraphia Indica II, Insu. XXIX p. 207 is an inscription on the image of Śrī Pārśva as is actually mentioned therein. It is a proof of the ancient and popular character of the worship of Śrī Pārśva.

of Pancaparameṣṭi Mantra. The famous Khārvel inscription which belongs to a date about two centuries before Christ begins thus:-

'NAMO ARAHANTĀNAM, NAMO SAVASIDHĀNAM'*

These two clauses are practically the same as the first two clauses of Pancaparameṣṭi Mantra. Cunningham's Archaeological survey of India XX (which describes Mathurā Inscriptions) Insn. No. XI, Plate XIII⁺ begins with obeisance to Arhantas and Siddhas thus, 'Namo Arhantānam Namo Siddhānam' These two clauses are the same as the first two clauses of Pancaparameṣṭi Mantra. It also refers to the fourfold congregation and is dated the year 62 which is equivalent to 140 Vikrama era. The said inscription shows that the said clauses were most probably borrowed from the famous Pancaparameṣṭi Mantra and establishes the antiquity thereof. Again Epigraphia Indica Vol. I p. 383, Insn. No. III begins thus 'Namo Arahantānam' i. e. 'Adoration to the Arhantas' which is the first clause of Pancaparameṣṭi Mantra.†

That Śrī Bhagavatī Sūtra, Kalpasūtra and Āvaśyakacūrṇi commence with the fivefold obeisance comprising the principal part of Pancaparameṣṭi Mantra also shows the antiquity thereof.

MANTRAKALPAS, MANTRAS AND VIDYĀS

Mantrakalpas are works dealing with Mantras and Yantras of various deities, their Pūjā and its essentials, their Sādhanā Homa, Bali etc., and Prayogas being particular employment of Mantras and Yantras for achieving various objects. Besides Mantrakalpas mentioned in this Introduction and Anubhavasiddhamantra-dvātriṃśikā, Padmāvatīkalpas, Sarasvatīkalpas and Ambikāmantras contained in the appendices hereto, we note below some important available Mantrakalpas, Mantras and Vidyās:-

* See J. B. O. R. S., IV, p. 397 & XIII p. 22 and Prācīna Jaina Lekha Saṅgraha Vol. I by Śrī Jinavijaya.

+ See Vienna Oriental Journal Vol. I (1887) p. 173.

† Insns. Nos. XVII (p. 390) and XXXIV (p. 397) Vol. I and Insns Nos. XXX to XXXII (p. 207) Vol. II Epigraphia Indica have the same obeisance.

1 Namaskāramantrakalpa 2 Pancanamaskāarakalpa 3 Panca-
 parameṣṭi Mahā Mantra Yantra Bṛhatkalpa 4 Mayūravāhinī Vidyā 5 Can-
 draprabha Vidyā 6 Candrapannatti Mantra Sādhana 7 Omkāarakalpa
 8 Hrīmkāarakalpas 9 Uvasaggaharamkalpas 10 Santikarastavāmnāya
 11 Tijayapahuttastotrāmnāya 12 Sattarisayayantravidhi 13 Nami-
 ūnakalpa 14 Bhaktāmarakalpas 15 Kalyāṇamandirakalpas 16 Logassa-
 kalpa 17 Śakrastavakalpa alias Namutthuṇamkalpa 18 Cintāmaṇi-
 kalpas 19 Cintāmaṇikalpasāra 20 Cintāmaṇisampradāya 21 Cintā-
 maṇi Mantrāmnāya 22 Cintāmaṇi Mantra Paddhati 23 Mantrādhirāja
 Kalpa 24 Aṭṭe Maṭṭe (alias Tribhuvana Vijayapatākā Mantra) Mantra Kal-
 pa 25 Dharaṇoragendrastava Kalpa 26 Kalikuṇḍa Yantra Mantra Kal-
 pas 27 Kalikundārādhanā 28 Śrī Pārśvanāthakalpadrumanmantrāmnāya
 29 Śighra sampattikara Pārśva Mantra 30 Pārśvanāthamantrārādhanā
 31 Jirāulī Pārśva Mantra Kalpa 32 Pārśva Stambhanī Vidyā 33
 Vaśyakara Gaurī Gāndharī Pārśva Mantra 34 Uvasaggahara Pārśva
 Yantra 35 Viṣāpahāra Pārśva Mantra 36 Putrakara Pārśva Yantra
 37 Sarvakāryakara Jagadvallabha Pārśva Yantra 38 Śāntikara Pārśva
 Yantra 39 Vādavijayakara Pārśva Mantra 40 Pārśva Cakra Mantra
 41 Rṣabha Cakra Mantra 42 Ariṣṭanemi Cakra Mantra 43 Vardha-
 māna Cakra Mantra 44 Sīmandhara Mantra 45 Dharaṇendra Lakṣ-
 mīkara Mantra 46 Dharaṇendra Kaṣṭāpahāra Mantra 47 Rakta Padmā-
 vatī kalpa 48 Rakta Padmāvatī Vṛddha Pūjana Vidhi 49 Śaivāgamokta
 Padmāvatī Pūjana including Sādhanās of Rakta Padmāvatī, Haṃsa
 Padmāvatī, Śārasvatī Padmāvatī, Śabari Padmāvatī, and Mokṣa Pad-
 māvati 50 Kāmeśvarī Padmāvatī Mantra Sādhana 51 Bhairavī
 Padmāvatī Mantrasādhana 52 Tripurā Padmāvatī Mantrasādhana
 53 Nityā Padmāvatī Mantrasādhana 54 Padmāvatī Dipāvatāra
 55 Padmāvatī Kajjalāvatāra 56 Mahāmohinī Padmāvatī Vidyā
 57 Putrakara Padmāvatī Mantra 58 Padmāvatīstotrakalpa 59 Pad-
 māvati Svapna Mantrasādhana 60 Padmāvatīkalpalatā 61 Padmāvatī

* Kalikunda yantra is given even in such a work on astrology (Svaraśāstra) as Nara-
 patijayacaryā, pp. 277-278.

Mantra Kalpas (by Merutuṅga & others) 62 Satrubhayanāśanī Pārśva Vidyā 63 Paravidyocchedanī Pārśva Vidyā, 64 Sūrimantrakalpas 65 Vardhamāna Vidyākalpas 66 Gaṇadhara Valayakalpas 67 Caturviṃśati Tirthaṅkara Vidyās 68 Vidyānuśāśana 69 Surapati Vajrapāṇi Mantra 70 Cakreśvarī alias Apraticakrākalpas (containing Rakṣā, Vādevijaya, Satrunāśa, Svapna, Ghaṭāvātāra, Lakṣmī, and Sarvasiddhikara Mantras) 71 Ambikā alias Kuṣmāndinīkalpas 72 Jwālāmālīnī alias Jwālīnī Kalpas, Yantras and Mantras 73 Siddhāyikā alias Kāmacāndālīnī Kalpa 74 Kurukullā Mantra Sādhana, 75 Pancāṅgulikalpas 76 Pratyāṅgirā Kalpas 77 Ucchiṣṭacāndālīnī Mantrasādhana 78 Karṇa Piśācinī alias Karṇa Piśācīkā Mantrasādhana 79 Cakreśvarī Svapna Mantra Sādhana 80 Svapnāvātī Mantra Sādhana 81 Ambikā Svapna Mantra Sādhana 82 Ambikā Ghaṭa-Darpaṇa-Jala-Dīpāvātāra 83 Śrutadevatāghaṭāvātāra 84 Śāśanadevī Mantra 85 Śrī Rṣabha Vidyā 86 Śāntinātha Vidyā 87 Śāntīdevatā Mantrasādhana 88 Ghoṇaṣa Vidyā 89 Aparājītā Mahā Vidyā 90 Rogāpahāriṇī Vidyā 91 Vāsupūjya Vidyāmnāya 92 Acchuptā Mantra 93 Brahmaśāntī Mantra 94 Gajamukha Yakṣa Mantra 95 Ṣodaśa Vidyā-devī Mantras 96 Bhāratī kalpa 97 Vāgvādinīkalpa 98 Sarasvatīkalpas 99 Sārasvata Mahāvidyā (by Śrī Bhadrabāhu) 100 (a) Śrutadevatāvidyā (b) Aparājītāmahāvidyā alias Vardhamāna Vidyā (c) Kurukullā Vidyā mentioned in Mahānīśītha Sūtra 101 Śrīdevīkalpa 102 Lakṣmī Mantra 103 Mahālakṣmī Mantra 104 Yoginī Mantrasādhana 105 Yakṣiṇī Mantrasādhana 106 Siddhacakra kalpa 107 Rṣimandalakalpa 108 Śrī Vidyākalpa 109 Brahmavidyākalpa 110 Māṇibhadrakalpas 111 Ghantākārṇa Kalpas 112 Ugra Vīrakalpa 113 Kṣetradevatā Mantrasādhana 114 Kṛṣṇa Gaurakṣetrapālasādhana 115 Khodiyā Kṣetrapāla Mantrasādhana 116 Bhairava Mantrasādhana 117 Batuka Bhairava Mantrasādhana 118 Svarṇākārṣaṇa Bhairava Mantrasādhana 119 Catuṣṣaṣṭhi Yogini Yantra 120 Śrī Gautamaswāmi Mantrasādhana 121 Śrī Vajraswāmi Mantrasādhana 122 Śrī Jinadattasūri Mantrasādhana 123 Śrī Jinakuśalasūri Mantra Sādhana 124 Śrī Jinacandrasūri Mantra sādhana 125 Śrī Hemacandrācāryakṛta Mantras 126 Panca Pīra Sādhana 127 Jnānārṇava-Mantras 128 Viśākhalpas

(relating to diagram of 20) 129 Pandariā Kalpa (relating to diagram of 15) 130 Uvasaggahara Caturviṃśati Jinavarayantra 131 Sarvakāryakara Catuṣtriṃśat Yantra 132 Pānsaṭhiā Kalpa (relating to diagram of 65) 133 Botteriā Kalpa (relating to diagram of 72) 134 Vijayantrakalpa 135 Vijayapatākākalpa 136 Jaitrapatākā Kalpa 137 Arjunapatākākalpa 138 Hanumatpatākā Kalpa 139 Trailokya Vijaya Yantra 140 Ghaṇṭārgala Yantra 141 Vajra Pañjara Mahāyantra Kalpa 142 Vajra Pañjarārādhana 143 Mṛtyuñjayasādhana 144 Candrakalpa (of Jagatsetha) 145 Diagrams of various numbers 146 Various Auśadhikalpas with relative Mantras e.g. Śvetārka, Svetaguñjā, Aparājitā, Rudantī, Mayūrasikhā, Śaṅkhāvali, Sahadevī, Siyālaśṅgi, Mārjārī etc. 147 Mantrāvalis 148 Pratiṣṭhākalpas.

CONCLUSION

Summing up the foregoing discussion on Jain Mantravāda and its history from the most ancient times to the present day we may observe that it would be clear to the readers on a careful consideration of the materials placed before them that Jain Mantravāda has its roots in the hoary past and is connected with Śrī Pārśvānātha, and possibly with Śrī Ṛṣabhadeva, Pārśvāpatyas, Naimittikas, Sārūpikas, Siddhaputras, Caityavāsis and numerous illustrious Āchāryas and Yatis who kept the Māntric tradition alive from generation to generation. It has remained an integral part of Jainism and has not separated from it and developed into an independent school of thought or philosophy like Vajrayāna which did develop into an independent school of Buddhism. The rigour with which the Jains dealt with laxity in observance of the rules of conduct for Sādhus by driving out of the fold those who least dared to tamper with the sacred fountains of Jainism, branding them as 'Nihnavas', acted as a great check upon the activities of the Jain Māntrikas and Jain Mantravāda did not degrade to the depth of adopting the abominable practices of Cīnācāra etc. Jain Mantravāda has taken its legitimate place in Jainism, as a kind of Yoga-Padastha Dhyāna, providing a practical and popular method of self-realisation through natural and convenient stages: Mantrayoga

for achieving individual or personal welfare, Mantrayoga for the general welfare and Mantrayoga without any exterior or worldly object meant only for the realization of the self. It has thus harmonised itself with the tenets of Jainism.

Thus Mantars and Vidyās have been recognised amongst Jains for securing the peace and tranquility of the body mind and soul from their respective afflictions howsoever caused. Mantrayoga is believed thus ultimately to confer even salvation on its practitioners if practised only with the object of realization of the soul. In the Pūrva literature as there are Jñānapravāda and Karma pravāda so there is Vidyānupravāda all forming important parts of the body of doctrines known as Jain philosophy. We may compare them with Jñāna, Karma and Upāsana of the Vedic philosophy. Here we conclude the general part of this Introduction.

✓ Contents

WE now come to the work proper. It is entitled Śrī Bhairava Padmāvati Kalpa as it deals principally with Mantras of Bhairavī Padmāvati.* 'Kalpa' is explained by the commentator as Mantravāda-samūha or a collection of Mantras. We have already stated that it deals with the Māntric worship of Sri Padmāvati, an attendant deity of Sri Pārsvanātha. There are ten chapters in this work. The first chapter describes the high qualifications necessary for a Sādhaka. The second chapter deals with Nyāsas+ and Śakalīkaraṇa or the protective rite and the rite corresponding to Bhūtaśuddhi and Dhyāna (v. 12). It also describes the method to ascertain whether a particular Mantra is favourable to the Sādhaka or otherwise. The third chapter deals with the mode of worship of the deity. The methods for the achievement of the sixfold Māntric object (Ṣaṭkarma) are first described and the different Māntric Pallavas, Vinyāsas, Postures, Mudrās, rosaries, modes of telling beads,

* Ch. I v. 3 identifies Padmāvati with Totalā, Tvaritā, Nityā, Tripurā, Kāmasādhinī and Tripurabhairavī. Nityās are sixteen, Tripurasundarī being Mahānityā. Tvaritā is the eighth Nityā and Kāmasādhinī is perhaps Kameśvarī Nityā—see Nityā Ṣodaśikārṇava I, p. 26, vv. 26-30. Tripurā has twelve 'Bhedas' i. e. variant forms—see Jñānārṇavatāntra XII, p. 39 ff. Uddhārakośa Tantra (p. 6 a) gives the twelve names including Bhairavī “ त्रिपुरा भैरवी विद्या हिङ्गुला चंडिका तथा ।

चामुंडा नारसिंही च ऐंद्री हैमवतीश्वरी ॥

मृडानी वारुणी दुर्गा महा त्रिपुरसुन्दरी ।

देव्या द्वादश नामानि प्रोक्तान्येतानि शूलिना ॥

Tripurābhairavī is one of the names of Tripurasundarī— see Jñānārṇavatāntra VI Paṭala. This explains why Padmāvati is styled Bhairavī Padmāvati and this work Bhairava Padmāvati Kalpa. There is no doubt that the author identifies Śrī Padmāvati with Śrī Vidyā alias Ṣodaśī. According to Niruttara Tantra Sundarī and Bhairavī belong to Śrīkula. For different forms of Padmāvati mentioned here, see Vidyānuśāsana, Samuddeśa IV, vv. 2 to 6 in Padmāsādhana. For identification of Tārā with Padmāvati see Sāadhanamālā vol. II p. 594 and of various deities with Padmāvati see appendix 5 v. 20, as also p. 63 ante.

+ Note the use of the five clauses of Pancaparamēṣṭi Mantra for the purpose.

directions and periods of time are prescribed for the achievement of the different objects of Māntric worship. The yantra for the worship of the Śrī Padmāvati is then described followed by Pancopacāra Pūjā (five kinds of worship). Then the Mūla-Mantra (principal Mantra), six-lettered, three-lettered and single-lettered Vidyās of Śrī Padmāvati and Homa are described. The Mantra of Pārśva Yakṣa and Cintāmaṇi Yantra are also described.

The Pancāṅga or the five parts relating to the Māntric worship of a deity are Paṭala, Paddhati, Stotra, Kavaca and Sahasranāma or a thousand names. This Pancāṅga is a later innovation. In modern works like Śāktapramoda there are Daśāṅgas or ten parts and even Dvādaśāṅgas or twelve parts. This kind of elaboration has nothing to commend as it merely mixes up the essentials with the non-essentials. The present work itself does not contain Stotra, Kavaca or Sahasranāma of Śrī Padmāvati but the same composed by other authors are given in the appendices to the main work. The third chapter as far as it deals with Mantroddhāra can be said to correspond to Paṭala and the matter contained in the second chapter viz. Nyāsa, Dhyāna etc. combined with the remaining matter of the third chapter would correspond to Paddhati. One of the Ṣaṭkarmas viz. Māraṇa‡ is termed Niṣedha i. e. one which is prohibited in conformity with the Jain doctrine of Ahimsā.

The mention of Pārśva Yakṣa is important to show that in the time of the author each Tīrthaṅkara had a separate attendant Yakṣa and Yakṣiṇī. The last verse describes Cintāmaṇi Yantra different from the famous Yantra of that name. We may note here that ancient non-Jain works like Nāradiyamahāpurāṇa describe Mantra for

‡ Some Kalpas like Śrī Cintāmaṇi-kalpa go further and say that one should not even think of such karmas (see p. 33 Jain Stotra-sandhoha Vol. II). It is stated in Jñānārṇava that such undesirable rites are described by saintly people only to satisfy the curiosity of ordinary people who would like to know whether Jain Mantras can achieve all kinds of objects which other Mantras are able to achieve.

Bali or oblation which is a Mantra of Padmāvati. It is “ॐ पद्मे पद्मे महापद्मे पद्मावतीये स्वाहा ॥” (See Nāradyamahāpurāṇa Adh. 85, vv. 133–134). Note the Prākṛit dative inflection of Padmāvati which shows the Jain origin of the Mantra as the Jains used only Prākṛit in the beginning. The fourth chapter describes twelve Yantras or diagrams for achieving different objects. The fifth chapter sets forth Yantras for accomplishing Stambhana i. e. stopping or paralysing persons and their activities and passing successfully through various ordeals. One of these Yantras relates to Vārtālī alias Vārāhī who is a Vidyā allied to Śrī Vidyā and is known as Dandinī.* It is meant for stopping motion, paralysing an army or the tongue of a rival debater or appeasing an angry person. A Prakrit Mantra invoking the 1st Tīrthaṅkara Śrī Ṛṣabha referred to in v. 8 and set forth verbatim in the commentary thereon is a part of this Yantra. This establishes the connection of Śrī Ṛṣabha with Mantravāda. We may also note that the commentary on v. 4 gives a Prakrit Mantra eulogizing Pancaparameṣṭi Mantra which is said to stop water and fire and to ward off great calamities caused by an enemy, epidemic, a thief or the king. Mantra of Ucchiṣṭa Cāndālīnī (Aṅga-Vidyā of Rāja-Mātaṅgī or Rāja Śyāmalā who is again a Vidyā allied to Śrī Vidyā) given in v. 12 as part of the diagram for successfully facing various ordeals shows the popularity that Mātaṅga Mantras had already attained. The sixth chapter gives Yantras and Mantras for attracting and fascinating women. Śrī Ambikā (whom the author perhaps identifies with Nityaklinnā as appears from her Mantra) Kṛṣṇa-Mātaṅginī, Nityaklinnā (the 3rd Nityā), Padmāvati and Kātyāyanī (a Vidyā allied to Śrī Vidyā) are invoked for the purpose in the various diagrams described in this chapter. The seventh chapter describes Yantras and Mantras for controlling and making others amenable to the will of or subser-

* Bahvṛcopaniṣat identifies Ṣodaśī alias Śrīvidyā with various deities as follows:—
 “ या भाव्यते सैवा षोडशी श्रीविद्या पञ्चदशाक्षरी श्रीमहात्रिपुरसुन्दरी बालाम्बिकेति बगलेति वा मातङ्गी स्वयंवरकल्याणीति भुवनेश्वरीति चामुण्डेति चण्डेति वाराहीति तिरस्करिणीति राजमातङ्गीति वा शुक्रश्यामलेति वा लघुश्यामलेति वा अश्वारूढेति वा प्रत्यङ्गिरा धूमावती सावित्री गायत्री सरस्वती ब्रह्मानन्दकलेति ॥”

vient to the Māntrika. Mantras arising from the five first syllables of Pancaparamēṣṭi Mantra and Anāhatavidyā and Prākṛit Mantra invoking the 22nd Tīrthaṅkara Śrī Ariṣṭanemi, and Mantras of Nitya-klinnā and Candeśvara may be noted.

The eighth chapter gives various Mantras for divining future through gazing in a mirror or lamp-flame or sword or water or the thumb to which soot and oil are applied. V. 13 describes such a Mantra for gazing in a mirror which is there stated to have been composed by Śrī Jina. This is very important as it ascribes authorship of a Mantra to Śrī Jina. The ninth chapter describes various herbs, medicines and powders for charming and fascinating men and women and making them subject to one's will, for gaining popularity, for striking terror in the heart of the enemy, for being invisible at one's will, for increasing business or vigour and for contraception. The commentary on v. 18 gives a Mantra invoking the eighth Tīrthaṅkara for preparing collyrium meant for charming.

The tenth and the last chapter deals with Gārudavidyā i. e. Vidyā for controlling and catching snakes and treating persons bitten by them. Mantras invoking Śrī Pārśva, Garuda, Bheruṇḍā Suvarṇarekhā and Kurukulla* are described. A magic serpent is described who would go to and bite the enemy named. Then a Mantra is given to prevent such serpent from biting. The method of initiating a person and imparting to him the traditional Mantra is described. Pancaparamēṣṭi Mantra with Jayā, Vijayā, Ajitā, Aparājitā, Jambhā, Mohā, Stambhā and Stambhini are there described for worship in a Yantra and also 'Svarṇapādukās' of Śrī Bhairava Padmāvatī. The pupil is warned not to impart the Mantra to a person who is not devoted to the

* Garuḍapurāṇa Adh. XIX vv. 14-15 gives Kurukulla Vidyā “ ॐ कुरुकुले स्वाहा ॥ ” which is said to have been possessed formerly by Garuḍa for the protection of the three worlds. Nāradiyamahāpurāṇa Adh. 85 v.12 refers to Kurukullā. Garuḍapurāṇa Adh. XIX v. 23 & v. 19 respectively describe Bheruṇḍā (a Nityā) and Suvarṇarekhā Vidyās.

Jain Faith and that he should impart it only to a person devoted to the Jain divinity, Jain preceptor and the Jain Faith. The author then mentions his preceptor Ajitasenagaṇi and the fact of his having secured a boon from Sarasvatī and composed Śrī Bhairava Padmāvatī Kalpa.

✓ The Author and the Commentator

MALLIṢEṆASŪRI is the author of Śrī Bhairava Padmāvati Kālpa and Bandhuṣeṇa is its commentator.

Malliṣeṇasūri a Digambara Jain Āchārya of Sena-gaṇa traces his descent in the colophon of the said work. He was the pupil of Kanakasenagaṇi and the grand-pupil of Ajitasenagaṇi to whom all the kings rendered obeisance. This Ajitasenācārya was none other than the famous Guru of King Rācamalla of Gaṅga dynasty and his minister and general Camundarai. In the colophons of his Nāgakumāra Kāvya and Jwālinīkalpa also he describes himself as the pupil of Jinasensūri. As Malliṣeṇasūri in the colophons of his work Mahāpurāṇa, and Bhāratīkalpa describes himself as the son of Śrī Jinasena, one is inclined to think that Jinasena must have been his father also. One cannot, however, be certain about it as Gurus are even now regarded in India as spiritual fathers. We have no more information about his parentage.

Malliṣeṇa in the colophon of his said work, Mahāpurāṇa gives its date as Jyeṣṭha Śukla 5th Śaka 968 (1104 Vikrama era). As his other works do not bear any date we are unable to fix even the period of his literary activity with any more certainty. We can only say that he flourished about the beginning of the twelfth century of Vikrama era.

From his titles* given in his various works, we can say that he was not only a great Māntrika but also a great poet of Sanskrit and Prākṛit, a grammarian, a dialectician and also versed in all the sacred scriptures and was favoured by Sarasvatī with a boon. From his two Sanskrit poetical works, Mahāpurāṇa and Nāgakumāra Kāvya it appears that he wrote in a simple and lucid style. Mahāpurāṇa contains the biographies of 63 eminent men in 2000 verses and Nāga

* “ गारूडमन्त्रवादवेदी, उभयभाषाकविशेखरः, उभयभाषाकविचक्रवर्ती,
सकलागमलक्षणतर्कवेदी, सरस्वतीलब्धवरप्रसादः, योगीश्वर इत्यादि । ”

kumāra Kāvya is a small poetical works in 5 cantos containing 507 verses. His fame however, rests on his Māntric works which appear to be mines of rare information no a cult which has always been very secretive and jealous of any information passing beyond its esoteric circle of adepts and initiates. Besides Śrī Bhairava Padmāvati Kalpa his Māntric works are Bhāratī alias Sarasvatī-Kalpa, Jwālinīkalpa and Kāmacāṇḍālinī, alias Siddhāyikā Kalpa.

VIDYĀNUSĀSANA

Vidyānuśāsana, a great compendium of Māntric treatises comprised in twenty four chapters containing nearly 7000 verses, is also ascribed to him. Probably, it is edited and enlarged by him. The text as now available contains several later additions and interpolations of Pandita Āśādhara's and Hastimalla's Gaṇadharavalayas, Āśādhara's Sarasvatistotra, and Rāvaṇa's Bālagraha Cikitsā and quotations from Imadi Bhattopādhyāya's Gāṇabhṛd-Yantra-Pūjā-Vidhāna and Mahasena's Trivarnācāra. On a consideration of the opening verses 1 and 2 and the verse 139 of the colophon which allude to Matisāgara we are inclined to believe that the author of at least the original nucleus was one named Matisāgara. The work contains a hymn of Śrī Pārśvanātha and large extracts from Jwālāmālinī Kalpa both by Śrī Indranandi of Dravida Sangha who was the pupil of Vappanandi and a grand-pupil of Vāsavanandi and a famous Māntrika who flourished circa Saka 861 i. e. 996 of Vikrama era which is the date of his Jwālinīkalpa. It must be therefore Matisāgara who, as is stated in the beginning of the work, extracted from and summarised ancient Māntric works of different authors,* and he must have flourished subse-

तेषु विद्यानुवादाख्यो यः पूर्वं दशमो महान् ।

मंत्रयन्त्रादिविषयः प्रथितो विदुषां मतः ॥ ९ ॥

तस्यांशा एव कतिचित् पूर्वचार्यैरेकधा ।

स्वां स्वां कृतिं समालंब्य कृताः परहितैषिभिः ॥ १० ॥

उद्धृत्य विप्रकीर्णैर्भ्यस्तेभ्यः सारं विरच्यते ।

एदंयुगीनानुद्दिश्य मंदान् विद्यानुशासनम् ॥ ११ ॥

quent to the said Indranandi. We know that the preceptor of the famous Vādirāja, who was a contemporary of Malliṣeṇasūri, was Matisāgara. Vādirāja and Malliṣeṇasūri appear to have been connected with each other, as Vādirāja in the second verse of the colophon of his Nyāyaviniścaya–Vivaraṇa refers to Kanakasena who is most probably the grand–preceptor of Malliṣeṇa and Narendrasena the co–pupil of Jinasena the preceptor of Malliṣeṇa. Further Matisāgara was a Maṭhapati of Siṃhapura and belonged to Dravida Saṅgha (which is called Jainābhāsa by Devasenasūri in his Darśanasāra) whose members being lax in the observance of the strict rules of conduct for Sādhus have been termed by Pt. Nāthurām Premi Digambara Caityavāsis, as their practices were very similar to the practices of Svetāmbara Caityavāsis described in the foregoing pages hereof including practice of Mantra, Nimitta and Medicine. Matisāgara, the preceptor of the famous Vādirāja, is therefore very probably the author of the original collection of Māntric treatises comprised in Vidyānuśāsana. As the work was principally a collection, it has induced later writers to add thereto or interpolate therein subsequent treatises and passages from various known and unknown writers which can be removed without affecting the unity of the work.

The question which is most material for our purpose, however, is why is the work ascribed to Malliṣeṇa and whether he had any and if so what part in the preparation of the text of Vidyānuśāsana devoid of later interpolations.

We may infer from what we have already stated before that a sort of summary prepared by Matisāgara of ancient Māntric treatises did come to the hand of the person who prepared the present enlarged text (without the later interpolations) of Vidyānuśāsana. Malliṣeṇa's connection with it, on a cursory survey of the text is only that it includes a hymn of Jwālinī which bears his name. Perhaps the inclusion in Vidyānuśāsana of the treatises on Padmāvati, Sarasvatī, Jwālinī, Kāmacāndālinī and Bālagrahacikitsā may further connect him in some

uncertain manner as he himself is said to have treated all these in independent treatises. Fortunately we have been able to secure a firmer footing in this connection by a detailed comparison of the text of Bhairava Padmāvatī Kalpa with the present text of Vidyānusāsana. It is that Vidyānusāsana contains within itself more than five sixths of Bhairava Padmāvatīkalpa. To be exact out of 308 verses (including 5 verses of colophon) of Bhairava Padmāvatī Kalpa 258 have been traced by us spread over fourteen different chapters out of the twenty four chapters of Vidyānusāsana. All the verses in chapters II to VII of Bhairava Padmāvatī Kalpa are traced; the untraced verses in chapters I, II, VIII, IX and X are only 10, 5, 4, 6 and 25 respectively. The subject in ch. X of Bhairava Padmāvatīkalpa is Gāruda (snake-charming and charms against snake-bites) which being a speciality of the author, as is apparent from his title 'Gārudamantravādavedi,' he has added new matter comprised in new verses which for that reason could not be traced in Vidyānusāsana. This accounts for the 25 untraced verses in the said X chapter, 5 of which form the colophon containing the author's lineage. The first chapter is introductory and describes the qualifications of a Māntrika. Here the matter to be treated being not Māntric and the author being a poet, he composed fine new verses.

A considerable portion of Sarasvatīkalpa of the author has been also traced by us in Vidyānusāsana. Portions of Jwālini Kalpa and Kāmacāndālī Kalpa are also traced in Vidyānusāsana. The text of Bālagrahacikitsā being not available to the writer has not been compared.

When we undertook the investigation, we never thought that such a large portion—practically the whole—of Bhairava Padmāvatīkalpa would be traced in Vidyānusāsana. What is the inference to be drawn? This cannot be a mere coincidence. It can neither be interpolation nor plagiarism. It cannot be former because it cannot be taken off from Vidyānusāsana without interfering with the current of narration and without interfering with the method, arrangement and sequence of the text. The portion is spread over practically the whole of Vidyānusāsana

and cannot be taken off without disturbing the unity of the work. This is the reason why we think that Malliṣeṇa must have been at least a redactor if not the author that is to say he has added much more of his own in Vidyānuśāsana than the portion of Bhairava Padmāvati-kalpa traced by us.

We cannot even imagine that an author of Malliṣeṇa's proud position bearing titles of being universal poet and an adept in Gāruda and Mantravāda could ever be supposed to be guilty of such wholesale plagiarism. From a statement in Jwālinīsādhana in ch. IV of Vidyānuśāsana that the three-lettered Vidyā of Jwālinī is not written by the preceptor so it should be learnt from him personally, we think that the editor or redactor was guided in the editing or preparation of the text by a living Guru who would have written the Vidyā if he chose. This shows that the redactor had a kernel or nucleus in writing composed by the living Guru who could be approached to learn the three-lettered Vidyā of Jwālinī. Probably the reference may be to Matisāgara who may have been living when Malliṣeṇa redacted the work under the guidance of the former. Probably Matisāgara might have been Vidyāguru to Malliṣeṇa being an adept in Mantravāda. It is significant that Vidyānuśāsana is styled 'Ārṣa' (ancient or composed by ancient sages) at the end of all the twenty-four chapters of the work and no name of the author is mentioned. If it was of sole ownership of Malliṣeṇa he would not have failed to subscribe his name as he has done in his other works. The only proper conclusion to be drawn is that he was the editor and redactor of the work.

We may note here that we have been led, as a result of the comparison of the text of Bhairava Padmāvati Kalpa with Vidyānuśāsana to believe that the former was composed after the redacted edition of Vidyānuśāsana was prepared. Sarasvatīkalpa, Jwālinīkalpa and Kamacāndālīkalpa also appear to have been subsequently composed.

Vajrapañjara-Vidhāna, and Bālagraha-Cikitsā are other Māntric works ascribed to him. Having had no access to them, we express no

opinion on the point. Sajjanacittavallabha, Ādipurāṇa, Pravacanasāratikā and Pancāstikāyatikā ascribed to Malliṣeṇa are not really his works. Pt. Nāthurām Premi in his recent compendium entitled "Jaina Sahitya aura Itihāsa" in Hindi surmises that Malliṣeṇa must not have been a Vanavāsi Sādhu i. e. a strict Sādhu living in a forest but must have been a Maṭhapati* i. e. one owning and residing in a monastery to which used to be attached lands and other properties yielding considerable income. He must have been practising Mantra, Nimitta and Medicine for the benefit of his pupils particularly his lay-followers.

Regarding the commentator Bandhuṣeṇa he only gives his name in the Maṅgala verse to his commentary. As he gives his name in plural we may surmise that he may have been an Āchārya. As his name has the suffix 'Sena' we may infer that he belonged to 'Sena gaṇa' or Sangha which was formerly called 'Panca Stūpānvaya'. From his obeisance to Śrī Pārśvanātha, we may infer that he was a Jain. As he calls the work the best of Kalpa we may infer that he held the work and its author in high esteem. In his commentary he does not merely explain difficult terms but supplements what is left unsaid by the author and even supplies Mantras and other details not given by the author. He thus shows extensive and intimate knowledge of Mantras and Māntric rites. He is equally at home while commenting on various herbs named in the original work and gives synonyms thereof from the local Karnāṭakī (Kanarese) language (See Com. on ch. IX vv. 21, 25 and 35). As he supplements detailed information where it is lacking in the original, and sets forth verbatim Mantras+

* Pt. Nāthurām Premi in his article "Vanavāsi Aura Caityavāsi Sampradāya" (p.347 ff.) in his above-mentioned work says Maṭhapatis or Mathavāsis (including later Bhaṭṭārakas or Yatis) amongst Digambara Jain Sādhus correspond to Śvetāmbara Caityavāsis and may be termed Digambara Caityavāsis as they equally indulged in lax practices.

See Com. v. 38 ch. III, which gives Śrī Pārśva Yakṣāś Mantra, Com. v. 17 ch. V gives Candaśūlinī Mantra, Com. vv. 4 and 19 ch. VI respectively give Kṛṣṇa Mātaṅginī Mantra and Kātyāyanī Mantra; Com. vv. 10 and 17 ch. VII respectively give Anāhata-vidyā and Ariṣṭanemi Mantra.

not even alluded to in the original, we may surmise that he must have been very closely connected with the author and might have been his junior co-pupil (Maillṣeṇa describes himself as the elder pupil of Jinasena in the colophon of his Jwālinī Kalpa) or his pupil. It is a fact however that much of such information and Mantras are given by the commentator from Vidyānuśāsana as we have ascertained from a detailed comparison of the work and the commentary with Vidyānuśāsana. There is no doubt that he has very ably commented on such a specialized work and laid the readers under great obligation by furnishing very accurate and exhaustive information on the subject. We may also infer that both the author and the commentator might have belonged to Karnātic from the references above mentioned in the commentary. About the author we can say from the knowledge of Purāṇic Mantras shown by him in the last chapter as noted in the 'Contents' of the present work that he was well acquainted with the Purāṇic literature and particularly Garudapurāṇa and Nāradyāmahāpurāṇa. The verses cited in the footnote * from the colophon of Kāmacāndālī Kalpa show that he wrote prose as well as poetry in Prakrit as well as Sanskrit in a charming style, was versed in uetrics or Prosody and Poetics, had such a marvellous Memory that he would not write any portion of his work till he completed the whole and that he was a favourite of Sarasvatī. From a verse* omitted in Sarasvatī Mantra Kalpa Appendix 11 after verse 76 we find that he styled himself Yogīndra.

× “ भाषाद्वयकवितायां कवयो दर्पं वहन्ति तावदिह । नालोकयन्ति यावत्कविशेखरमल्लिषेणमुनिम् ॥१॥

छन्दोऽलंकारशास्त्रं किमपि न च पर प्राकृतः संस्कृतं वा

काव्यं तच्च प्रबंधं सुकविजनमनोरंजनं यः करोति ।

कुर्वन्नुर्वीक्षलादौ न लिखति किल तद् याति यावत्समाम्निम्

स श्रीमान्मल्लिषेणो जयतु कविपतिर्वाग्धूमण्डितास्यः ॥२॥”

कामचांडाली कल्पात्

* “ वाक्पतेर्वादिवेतालादभयेंदोश्च पद्मलात् । श्री मल्लिषेणयोगीन्द्रादेशाद्विद्या समागता ॥ ”

सरस्वतीमंत्रकल्पात्

✓APPENDICES

APPENDIX 1-ADBHUTA PADMĀVATĪ KALPA

WE now turn to works in appendices. 'Adbhuta Padmāvatī Kalpa' of Candrasūri, a pupil of Svetambara Upādhyāya Yāsobhadra, is contained in Appendix I. It is a work in six chapters but the first two chapters are missing. Indranandi is mentioned in v. 50 ch. IV and after v. 15 ch. V of the said work and described respectively therein as Guru and Mantravādi-Vidyā-Cakravartī-Cūdāmaṇi This is enough to identify him as the famous Digambara Jain Māntrika who flourished circa 996 Vikrama era. The very high regard shown by the author for Indranandi shows that it was probably under the influence of his Māntric works that 'Adbhuta Padmāvatī Kalpa' was written. The mention of 24 companion-deities and 20 Dandeśas of Śrī Padmāvatī in the Yantra described in ch. IV of the work is novel. The arrangement of the Yantra is probably borrowed from some work of Indranandi. * Inclusion of Pratyāṅgirā, Ambikā, Jwālāmālīnī and Cakreśvari in the Yantra shows the popularity of these deities at the time. † Details of worship of Śrī Padmāvatī are also given in the said chapter. V. 53 ch. IV gives Dhyāna of Padmāvatī which is different from that given in Bhairava Padmāvatī Kalpa in that one of her arms bears a lotus instead of the divine fruit. V. 19 ch. IV gives Padmāvatī's following Mantra. "ॐ अँ क्राँ ह्रीँ ऐँ क्लीँ त्रैँ पद्मावत्ये नमः ।"

This is different from the five Mantras described in Bhairava Padmāvatī Kalpa. The third chapter describes protective rite and

* Cf. Mālāmantra in ch. VI with Mālāmantra given in the beginning of Indranandi's Padmāvatīpūjana in Appendix 2.

† Jinsenācārya who composed Harivaṃśapurāṇa in Saka 705 i. e. 840 Vikram era refers to 24 Śāsanadevatās and praises therein Apraticakrā alias Cakreśvarī and Ambikā which shows popularity of their worship at the time. Here is the verse:

प्रहीतचक्रप्रतिचक्रदेवता तथोर्जयन्तालयसिंहवाहिनी ।

शिवाय यस्मिन्निह सन्निधीयते क्व तत्र विघ्नाः प्रभवन्ति शासने ॥४४॥

Bhūtasuddhi. We surmise that the first and second chapters of the work may have contained Māntrilakṣaṇa and Divyādivya grahalakṣaṇa as are contained in Jwālinīkalpa of Indranandi. The fifth chapter deals with invoking the deity in the body of a suitable person. The sixth chapter gives Śrī Kalikuṇḍa Pārśvanātha Yantra to cure affliction by evil spirits and also to remove other troubles. Another Yantra and Mantras are then described for the same purpose.

The importance of this work is that it very probably reflects an earlier mode of worship and gives Mantra and Yantra of Padmāvati as in vogue in the time of Śrī Indranandi that is at least a century prior to Malliṣeṇasūri.

It is difficult to say who Candra and Yaśobhadra Upādhyāya were and when exactly they flourished. From v. 6 ch. V in which Padmāvati is identified with various principal deities of other cults we are able to surmise that the author must be later than 1203 Vikrama era when Pārśvadevagaṇi wrote his commentary on Padmāvatiyaṣṭaka as he had not the verse 20 of Padmāvatiṣṭotra (Appendix 5) before him and did not therefore comment upon it. The fact is that the hymn being very popular several subsequent additions to it have been made from time to time and v. 20 is a part of such later addition. This verse appears to have been paraphrased as v. 6 ch. V of Adbhuta Padmāvati Kalpa. We can therefore only say that the author must have flourished considerably later the 1203 Vikrama era. We may also note that there was one Yaśobhadrasūri of Harṣapuriya Maladhāri Gaccha who in 1270 Vikrama era took part along with others in revising Devaprabhasūri's Pāṇḍavacaritra. He may be supposed to have had a pupil named Candra when Yaśobhadra was only Upādhyāya and not Āchārya or Sūri. The famous Saiddhāntika and logician Muncandrasūri, the pupil of Yaśobhadrasūri of Bṛhadgaccha was certainly not the author. That the author had not perhaps before him Malliṣeṇa's Bhairava Padmāvati Kalpa can be explained by the fact that after the historic debate in Siddharaj's time in 1181 Vikrama era and the defeat

therein and consequent expulsion from Gujarat of Digambara Jains the works of the latter were not readily available to Śwetambara Jains.

APPENDIX 2 PADMĀVATĪPŪJANA

Appendix 2 contains 'Padmāvatīpūjana' by Indranāndi already mentioned. He is styled Yogīndra. He recast the old Jwālinī Kalpa of Śrī Helācārya alias Elācārya, as it was difficult to understand, completing it at Mānyakheta, the capital of King Śrī Kṛṣṇarāja, on Vaisākha Sukla 3rd Śaka 861 i. e. 996 Vikrama era. Indranandi in his Jwālinīkalpa mentions Gāṅgamuni (Elācārya's pupil), Vijābja, Āryā Kṣāntirasabbā, Viruvaṭṭa, Kandarpa and Guṇanandi as the seven persons through whom knowledge of Jwālinīmata was handed down to him, he having been directly instructed by the last two jointly. We may therefore reasonably suppose Elācārya to have lived about 150 years earlier i. e. about 850 Vikrama era. Indranandi was a very famous Digambara Jain Māntrika and must have written other Māntric works also. From the fact that Vardhamānasūri (1468 Vikrama era) mentions at p. 150 in his Acāradinakara Vol. II Indranandi along with others as authors of Pratiṣṭha-Kalpas (works on installation ceremonies), we may infer that he must have written a Pratiṣṭhākalpa. Vidyānuśāsana ch. V gives a hymn of Pārśvanātha with commentary which mentions him as its author.

APPENDIX 3-RAKTA PADMĀVATĪ KALPA ETC.

Appendix 3 contains 'Rakta Padmāvatī kalpa'. It comprises Mantras, Yantras, a hymn and a special mode of worship of Padmāvatī. From the fact that the Yantra is called second in the subscription one may think that there must have been the first Yantra which is now missing. From the abrupt and unconnected manner in which different subjects are treated one gets the impression of there being lacunae in the work. There is no data even to venture a surmise as to the author of the work. From the language of Pūjanavidhi one may think it to be not earlier than the 15th century of Vikrama era. The other parts are in Sanskrit and we are not sure whether they were written

at one and the same time. We may note here that there is a red-coloured image of Śrī Padmāvati in a standing posture carrying Śrī Pārśvanātha's image on her head in Śrī Pārśvanātha's temple at Narodā near Ahmedabad and that as stated before (p. 251 ante) Pandita Śrī Viravijaya performed Sādhanā of Rakta Padmāvati.*

There is also in Śrī Pārśvanātha's temple at Tokersha's pole, Jamālpur, Ahmedabad, a red-coloured sand-stone image of Śrī Padmāvati with five hoods carrying thereon an image of Śrī Pārśvanātha and holding in her two upper hands a goad and a lotus and showing Varadamudrā with the other two.

APPENDIX 4 ŚRĪ PĀRŚVANĀTHASTOTRA ETC.

Amongst the works contained in this Appendix, the really important and old work is the hymn commencing with the words 'Śrī -maddevendra-Vṛndā' etc. There is a very famous Māntric hymn of Indranandi commencing with the words 'Śrīmannāgendra-rudra' etc. The former does not bear the name of the author but the later bears that of Indranandi. The former is given in Vidyānuśāsana after the latter. In Vidyānuśāsana ch. IV in Jwālinīsādhanavidhi is given a hymn of Śrī Jwālinī which begins with the words 'Śrīmaddaityorugendra' etc. This is followed by a hymn by Śrī Malliṣeṇasūri, which means that the hymn of Jwālinī given first is very probably by an older writer. If we are justified in indentifying the author of this hymn with the author of Śrī Pārśvanātha's said hymn, which follows Indranandi's Śrī Pārśvanātha's hymn in Vidyānuśāsana, because both commence with 'Śrīm', then we may say that he must have lived after Indranandi and before Malliṣeṇasūri i. e. between 996 and 1104 Vikrama era. One feels a little doubt as Indranandi's hymn also begins with 'Śrim', but there

*In Śrī Ajitanātha's temple in the rear of the Upāśraya at Bhaṭṭhinī-Bārī at Ahmedabad which came to be known as Viravijaya's or Vīra's Upāśraya (see p. 250 ante) there is a bronze image of Śrī Padmāvati before which, as was reported by Śrī Gulābvijayaji a sādhu in his line, Viravijayaji performed Sādhanā and obtained a boon from Śrī Padmāvati.

is really no scope for it because Indranandi appears to expressly mention his name in the body of his hymn or work as he has in fact done in the said hymn of Śrī Pārśvanātha and also his Jwālinīkalpa. That Jwālinīstotra commencing with the words 'Śrīmaddaityorugendra' is not Indranandi's is certain as the vehicle of Jwālinī in the first verse thereof is said to be a lion instead of the he-buffalo mentioned by Indranandi in his Jwālinī-kalpa. Both Elācārya and Malliṣeṇa describe the vehicle to be a he-buffalo.

We may here state in anticipation that we are inclined to think that the same author also composed the famous Padmāvatyāṣṭaka which has been much enlarged by subsequent additions as given in Appendix 5.

The other works in Appendix 4 viz. two Aṣṭakas, Jayamālā etc. are in ungrammatical Sanskrit and are meant to be recited while performing Pūjā.

APPENDIX 5-PADMĀVATĪ STOTRA ETC.

Appendix 5 gives the enlarged version of the famous Padmāvatyāṣṭaka. The first eight verses are the original verses and with verse 32 as the 9th verse comprise the original hymn, the ninth verse being meant to narrate the fruits to be gathered by the recital of the hymn. The 33rd verse of the hymn, as given, in this appendix, is of a similar nature and contains 'Falaśruti' by the redactor. VV. 34 to 36 prove conclusively that the original hymn contained only eight verses. Because the 32nd verse has the word 'Dānavendraiḥ' some think it must have been composed by some Dānavendrasūrī. We are not aware of any such Sūrī. As the hymn was popular even in the time of the commentator Pārśvadevagaṇi i. e. in 1203 (he terms it 'Lokaprasiddha') it must have been written at least a century earlier. We think, as already stated above, that the author of this hymn must be the same as the author of Pārśvanāthastotra and Jwālinīstotra above mentioned. The five other works are Aṣṭaka, Pratyekapūjā, Jayamālā, Padmavatīdaṇḍaka and Padmāvati Paṭala. All these except Daṇḍaka

appear to have been composed under the influence Padmāvatyāṣṭaka. Aṣṭaka is merely an adaptation of 'Sārdāṣṭaka' contained in Sarasvatīkalpa of Arhaddāsa. The latter contains only eight verses while the former contains twelve verses. Only the last four verses appear to be newly composed by the writer adapting Sārdāṣṭaka. The Mantras at the end of the Daṇḍaka are probably from another Mantrakalpa. The language of Pratyekapūjā and Jayamālā at many places borders on Sankritized Hindi and at other places it is ungrammatical Sanskrit.

Referring to Padmāvati Paṭala we can say that some one has composed it in close imitation of the famous Padmāvatyāṣṭaka. We may refer to a similar hymn viz. Śrī Cakreśvaryāṣṭaka contained in Appendix 23. The unknown authors had perhaps the same model of Śrī Padmāvatyāṣṭaka before them and might be identical. Aṣṭaka, Pratyekapūjā and Jayamālā are probably by some Digambara Jain writers.

We would note here that Bhāskararāi the famous author of Bhāṣya on Lalitāsahasranāma cites while commenting on the words 'शक्तयो विविधाकाराः' in v. 36 a passage * from Rudrayāmala which gives names of some well-known Shaktis. Both Padmāvati as well as Tārā are included therein. As noted by us in the footnote at p. 295 ante Padmāvati is identified with various deities including Tārā. If one is rash enough to infer from such identification that Padmāvati was not independently worshipped and that Padmāvati is only another name of Tārā the above passage from Rudrayāmala would be an

“पराशक्तिश्चादिशक्तिरिच्छा ज्ञानक्रियाबला ।
 बालान्नपूर्णा बगला तारा वाग्वादिनी परा ॥
 गायत्री चैव सावित्री सिद्धलक्ष्मीः स्वयंवरा ।
 नकुली तुरगास्तु कुरुकुला च रेणुका ॥
 संपत्करी च साम्राज्यलक्ष्मीः पद्मावती शिवा ।
 दुर्गा भद्राकृतिः काली कालरात्रिः सुभद्रिका ।
 छिन्नमस्ता भद्रकाली कालकण्ठी सरस्वती ॥”

eye-opener for it names Padmāvati and Tārā as distinct Shaktis. Further carried to its logical extreme such argument would eliminate all the deities identified and one would have to come to the absurd conclusion that no deity except Tārā ever existed. The passage also shows that both Padmāvati and Tārā were known before the advent of Buddhist Tantras, as Rudrayāmala is known to be an earlier work. Further, Vairoṭyāstotra of Ārya Nandila (circa 130 Vikrama era) expressly mentions Padmāvati.

“जा धरणोरगदइया देवी पउमावई अ वइरुहा ।

सप्यसइस्सेहि जुभा देवी किर किंकरा जाया ॥२॥” वैरोध्यास्तोत्रम् ॥

Nirvāṇakalikā p. 37 also mentions Padmāvati. The text of Uvasagga-harastotra purporting to include the Māntric gāthās * belived to have been secreted away to prevent abuse thereof also mentions Padmāvati in three of them as follows:—

“ॐ ह्रीं श्रीं पास विसहर विज्जामंतेण प्राणज्जायब्बो ।

धरण पउमावइदेवी ॐ ह्रीं क्ष्म्व्यू स्वाहा ॥८॥

ॐ थुणामि पासं ॐ ह्रीं पणमामि परमभत्तीए ।

अइक्खर धरणिदपउमावई पयडियकित्ति ॥९॥

जस्स पयकमले सया वसइ पोमावई धरणिदो ।

तस्स नामेण सयलं विसहरविसं नासेई ॥१०॥”

This will conclusively prove the ancient character of the worship of Śrī Padmāvati much earlier than the 7th century A. D. †

APPENDIX 6

Appendix 6 contains a hymn to Śrī Padmāvati by Muncandra alias Muncandranātha who cannot be identified with any of the three famous Muncandrasūris who flourished in the 12th century of Vikrama

* They are probably of later date than the original text of 5 gāthās.

† Śrī Padmāvati's 'parivāra' can be ascertained from her Yantra, vv. 13 to 21, ch. III, Bhairava Padmavati Kalpa. It may be interesting to note that there is a marble image of Śrī Padmāvati in a Jain temple at Idar showing the same symbols as are described in her Dhyāna in v. 12, ch. II ibid. as has been observed by Mr. Sarabhai Nawab the publisher hereof.

era as the hymn is neither in correct Sanskrit nor free from metrical faults. We can only conjecture that the author may perhaps be identified with Municandra who wrote 'Rasāulo' in 1577 Vikrama era or with Municandra of Paurṇamikagaccha who flourished circa 1550 Vikrama era. The correct name of the hymn as appears in the colophon of a copy thereof in the writer's possession is 'Prakaṣa Padmāvatīstotra' and the said colophon also mentions it to be a part of 'Devīpāṭha'. The author there is said to be Municandrācārya. It is apparently in imitation of 'Durgārājastotra' which begins with the words 'या देवी खड्गहस्ता' The only noteworthy feature of the hymn is the effect produced by alliterative words therein.

APPENDIX 7

Appendix 7 contains the famous Cintāmani Mantra of Śrī Pārśvanātha and various Mantras and Dhyāna of Śrī Padmāvatī and Mantra of Haṃsa Padmāvatī. The work really ends before the words 'सम्प्रति पद्मानतीमहादेव्याः कल्पे लिख्यते ।' Another Kalpa of Padmāvatī is commenced with the said words. Of this Kalpa only the first two Mantras are given and it is then left incomplete. The author of the work is not known. In imitation of non-Jain Mantras the author has given Ṛṣi (seer) etc. While mentioning 'Kīlaka' he has not realized that Jain Mantras do not require any Suddhi or Purification nor any removal of Kīlaka or Sāopddhāra See vv. 60-61 ch. 24 (P. 222), Mantra Mahodadhi.

APPENDIX

Appendix 8 contains a hymn comprising a thousand names of Śrī Padmāvatī which seems to have been composed apparently to complete the Pancāṅga or the five parts of the worship of the deity. The five parts are: 1 Paṭala 2 Paddhati 3 Kavaca 4 Stotra and 5 Sahsrānāma. In Paṭala Mantra is evolved from the technical terms used to signify various Māntrabījas or letters forming a Mantra; Paddhati gives details of worship including Dhyāna; Kavaca is a hymn meant for the protection of the Sādḥaka; Stotra is a simple hymn and Sahasranāma or Sata-nāma is enumeration of a thousand or hundred names in the form of a hymn.

In this hymn Padmāvati is described as 'Mantrarūpā ca Mantra-
jñā Mantradā Mantrasāgarā' identifying her with Mantra. We would note
here some of the important appellations identifying her with various
well-known deities: Lakṣmī, Mahālakṣmī, Kamalā, Śrīrūpā, Ramā,
Maheśvarī, Mahādevī, Sivā, Satī, Candī, Durgā, Vṛṣārūdhā, Bhuva-
neśvarī, Sarasvatī, Bhārati, Sādhvī, Bhagavatī, Khecarī, Kāmadhenu,
Kālī, Kālikā, Bālā, Vajrā, Vedamātā, Vīramātā, Jinamātā, Jainesvarī,
Yoginī, Yogeśvarī, Nāginī, Nāgakanyā, Nāganātheśavallabhā, Bhuja-
gākāraśāyini, Kundalinī, Satcakrabhedavikhyātā, Līlāvati, Tripurā,
Sundarī, Tripurasundarī, Tripurabhairavī, Bhairavī, Bhīmā, Tārā,
Totalā, Tvaritā, Kāmasādhinī, Kātyāyanī, Śivadūtī, Gaurī, Gāndhārī,
Jwālīnī, Jwālāmukhī, Ambikā, Cakreśvarī, Cintāmani, Jayā, Vijayā,
Jayantī, Omkārarūpā, Hrīṃkārarūpā, Tārā and Tārāmānavimardinī.
From the last appellation which is found in v. 29 of Padmāvatiya-
ṣṭaka, we may surmise that probably this hymn was composed
after the redaction of Padmāvatiyaṣṭaka i. e. circa 17th century
Vikrama era as we surmise that to be the date of the redactor (perhaps
some Jayavijaya see v. 33) of Padmāvatiyaṣṭaka. Nothing is known
about the author of Padmāvatisahasranāma.

APPENDIX 9

This appendix 9 also contains a hymn of Padmāvati containing
identifications of Śrī Padmāvati with well-known deities. Some of
them not already noted above are Vairoṭyā, Prajnapti, Mahākālī,
Bhadrakālī, Kāmākṣā, Jagadambā, Annapūrṇā, Śrīvidyā, Bhavānī,
Mātāṅgī, Rājamātāṅgī, Hīngulāja, Pītā (not Piṭhā) or Bagalāmukhī,
Vāgvādinī, Śāradā, Kuṣmāṅdī, Śākambharī, Camuṇḍa, Mahāmāyā,
Gāyatrī, Vardhamānavidyā and Bāhubali. Her Vāhanas are said to
be the lion and the swan. V. 11 refers to the single lettered, three-
lettered, six-lettered and fifteen-lettered Vidyās of Śrī Padmāvati. We
are unable to trace the author of this hymn.

APPENDIX 10

This appendix 10 contains a hymn of Śrī Padmāvati in Apa-
bhraṃśa dialect by Śrī Jinaprabhasūri whose life we have already

described and have also shown therein the Mūlamantra and the single-lettered Vidyā of Padmāvati contained in the said hymn. There is a reference to Yantra of 65 in v. 25 and in v. 34 it is stated that the benefit received by the favour of Śrī Padmāvati obtained through the recital of Cintāmani Mantra (ॐ ह्रीं नमः—see v. 18) which grants every desire equals to that received by the combined favour of all the 16 Vidyā-devīs through perfection achieved by the Sādhaka through their Sādhanā.

SARASVATĪ

As all the works contained in Appendices 11 to 15 relate to Sarasvatī, we shall offer some preliminary remarks relating to the ancient character of her worship and her various 'Vāhanas' and symbols.

The images including those of Sarasvatī and Ambikā discovered from the excavations of the Jain Stūpa at Mathurā proves that Sarasvatī and Ambikā were worshipped by the Jains in ancient time (see ante p. 256). The statue of Sarasvatī discovered there is headless. "The goddess is shown sitting squatted with her kness up on a rectangular pedestal, holding a manuscript in her left hand. The right hand which was raised has been lost. The figure is clothed in very stiffly executed drapery, a small attendant with hair dressed in rolls stands on each side. The attendant on the left wears a tunic and holds a jar—the attendant on the right has hands clasped in adoration." Plate 99, p. 56, The Jain Stūpa and other Antiquities of Mathura by V. A. Smith.

Śrī Bhagavatisūtra Vol. III p. 979 and Pakkhisūtra p. 71 have verses in praise of Śrutadevatā alias Sarasvatī which show that the worship of Sarasvatī amongst Jains is very old; see also the passage from Mahānisītha cited in the footnote at p. 257 ante.

It is interesting to note that Sūtradhāra Maṇḍana gives 12 'Bhedas' or variant forms of Sarasvatī* with their names in his

[अथ द्वादश सरस्वत्यः]

एकवक्त्रा(ः) चतुर्भुजा मुकुटेन विराजिता(ः) ।

प्रभामण्डल संयुक्ता(ः) कुण्डलान्विता शेखरा(ः) ॥७९॥ [इति सरस्वतीनां साधारणलक्षणम्]

Devatāmūrtiprakaraṇa, Adh. VIII, vv. 79 to 85, pp. 159–160. Of these the symbols of Sarasvatī as described in v. 81 are identical with those of Śrutadevatā alias Sarasvatī in Nirvāṇakalikā. * According to Agnipurāṇa§ Sarasvatī holds a book, a rosary and Vīṇā or lute (in two hands). Vāyupurāṇa describes her as showing in her right (lower) hand Varadamudrā and holding in the right (upper) hand a rosary and in the left (upper) hand a book and showing in her left (lower) hand Abhayamudrā. Most of her Purāṇic descriptions as also Sarasvatī-rahasya Upaniṣad give her a book and a rosary. According to the Jain tradition however most of the older descriptions give her a lotus and a book and describe her as sitting in a lotus—See Kalyāṇakandam Stuti and Śrī Haribhadrasūri's Saṃsāradāvā Stuti; see also v. 11 Sarasvatīstotra, Appendix 12, also Bappabhattisūri's Catūrvimśatikāstuti v. 76, v. 26 Ch. 4 Anubhavasiddhamantra-dvātriṃśikā, Appendix 30 and the Stuti from Pancakalpabhāṣya (see footnote p. 257 ante.)

अक्षपद्मं वीणा पुस्तकं (पुस्तं) महाविद्या प्रकीर्तिता ।	[इति महाविद्या १]
अक्षं पुस्तकं (पुस्तं) वीणापद्मं महावाणी च नामतः ॥८०॥	[इति महावाणी २]
वराक्षपद्मपुस्तकं शुभावहा च भारती ।	[इति भारती ३]
वराम्बुजाक्षपुस्तकं सरस्वती प्रकीर्तिता ॥८१॥	[इति सरस्वती ४]
वराक्ष पुस्तकं पद्मं आर्या नाम प्रकीर्तिता ।	[इत्यार्या ५]
वरपुस्तकाक्षपद्मं ब्राह्मी नाम सुखावहा ॥८२॥	[इति ब्राह्मी ६]
वरपद्मवीणा पुस्तकं महाधेनुध नामतः ।	[इति महाधेनुः ७]
वरं च पुस्तकं वीणा वेदगर्भा तथाम्बुजम् ॥८३॥	[इति वेदगर्भा ८]
अक्षं तथाऽभयं पद्मं पुस्तकेनेश्वरी भवेत् ।	[इतीश्वरी ९]
(असपद्मं ? अक्षाभयं) पुस्तकं च महालक्ष्मीस्तथोत्पलम् ॥८४॥	[इति महालक्ष्मीः १०]
अक्षं पद्मं पुस्तकं च महाकाल्यभयं तथा ।	[इति महाकाली ११]
अक्षपुस्तकमभयं पद्मं महासरस्वती ॥८५॥	[इति महासरस्वती १२]

* श्रुतदेवतां शुक्लवर्णां हंसवाहनां चतुर्मुजां वरदकमलान्वितदक्षिणकरां पुस्तकाक्षमालान्वितवामकरां चेति ।

§ पुस्तकाक्षमालिकाहस्ता वीणाहस्ता सरस्वती ।

Very early *Vīṇā* or the lute seems to have been substituted for *Varādamudrā*—see v. 6 *Sarasvatīstotra*, appendix 12, also *Viṣṇudharmottarapurāṇa*, III, Adh. 64, vv. 1 & 2. *Vīṇā* then continues to be very popular and becomes an invariable symbol of *Sarasvatī*. Her seat of lotus loses popularity and *Haṃsa* or swan is universally accepted as her *Vāhana*. It is a fact that amongst *Śvetāmbara* Jain sculptures the image of *Sarasvatī* with the vehicle of a pea-fowl or pea-cock has not yet been found. It was the famous painter *Ravivarmā* who was responsible for showing a pea-cock as the *Vāhana* of *Sarasvatī*. The confusion is perhaps due to an unwarranted identification of *Sarasvatī* with *Kaumārī* i. e. *Śakti* of *Kumāra* whose *Vāhana* is a peacock. Because *Sarasvatī* is traditionally believed to be *Kumārī* i. e. virgin, she is taken to be the same as *Kaumārī Śakti*. Amongst Jains also there is *Prajñapti Vidyādevī* whose *Vāhana* is 'Mayūra' or a peacock and there is a *Mayūravāhini Vidyā* referred to in *Pāncapārameṣṭi Mahā-mantra Yantra Bṛhat Kalpa*: but none of these is *Sarasvatī*.

Āśādhara in his *Pratiṣṭhāsāroddhāra* gives the Mantra of *Mayūravāhinī* and says that with that Mantra *Vāgvādinī* should be installed. Thus amongst the *Digāmbara* Jains *Sarasvatī* came to be identified with *Mayūravāhinī* and since *Āśādhara*'s time some *Digāmbara* Jain sculptures of *Sarasvatī* are found with the peacock as her *Vāhana*. *Āśādhara* himself has also described *Sarasvatī* as *Puṇḍarīkāsānā* having the lotus as her seat. Later *Digāmbara* Jain writers have following *Āśādhara* described her either as *Mayūravāhinī* or *Puṇḍarīkāsānā* and some as *Haṃsavāhanā*.* The confusion is perhaps due to loss of the old tradition and mixing up of *Mayūravāhinī* with *Sarasvatī*. It can however be said without fear of contradiction that no ancient image of *Sarasvatī* is found with the peacock as her vehicle.

APPENDIX 11

Sarasvatīkalpa by *Śrī Malliṣeṇasūri*, the author of *Śrī Bhairava*

* See hymns to *Sarasvatī* by *Malayakīrti* and *Arhaddāsa* contained in *Malayakīrti's Sarasvatīkalpa*.

Padmāvati Kalpa, is comprised in Appendix 11. V. 2 thereof gives Dhyāna and symbols of Sarasvatī. V. 28 refers to the single-lettered Mantra viz. Hrīmkāra for achieving perfection in the Sādhanā of Sarasvatī. It may be noted that the Mantra is the same as the single-lettered Vidyā of Śrī Padmāvati. There are lacunae (1) after vv. 34 and (2) after v. 37 (p. 64) and (3) after the Mantra given after v. 65 (p. 66) and (4) after v. 76 (p. 67) which the readers will find filled in the footnote* from the writer's copy of Sarasvatī Kalpa.

APPENDIX 12

In this appendix is a beautiful Māntric hymn to Sarasvatī by Śrī Bappabhattsūri. He flourished from 800 to 895 Vikrama era. This was the time when Buddhist Tāntrikas known as Siddhas × made Tantras as well as Kundalinīyoga popular. With Sahajayānists who followed the earlier Siddhas Pañcatattva worship and other objectionable practices spread and ultimately Śrī Sankarācārya, (circa 8th century A. D.) in opposition to Vāmācāris advocated Samayamata. It lays

- * १ ॐ ह्रीं क्लीं क्लीं जम्भे मोहे अमुकं वशं कुरु २ वषट् ॥ वश्ययन्त्रम् ॥
 (तद्यथा) २ ॐ ओं क्रौं ह्रीं अम्बे अम्बाले अम्बिके यक्षिदेवि यम्ब्व्यूं व्ले र्यूं ह्रीं व्ले ह्रीं ररर
 रां नित्यविलम्बे मदद्रवे मदनातुरे अमुकं आकर्षय २ घे २ संवौषट् ॥
 ३ द्वादशसहस्रजपैः दशांशहोमेन सिद्धिमुपयाति ।
 मंत्रस्त्रिभुवनसारः गुरुपदेशात्स विज्ञेयः ॥
 ४ वाक्पतेर्वादिवेतालादभयेदोष पद्मलात् ।
 श्रीमल्लिषेणयोगीन्द्रदेशाद्विद्या समागता ॥

× Luipā or Ādisiddha (cira 669 A. D. according to Dr. Bhattāchārya but circa 769-809 A. D. according to Pt. Rāhula Sāṅkṛtyāyana) and Jālandharapā alias Hādipā known as Ādinātha, his pupil Matsyendranātha, and the pupil of latter Gorakṣanātha alias Anaṅgavajra (circa 705 A. D. according to Dr. Bhattāchārya but circa 809-849 A. D. according to Pt. Rāhula Sāṅkṛtyāyana) were some of the famous 84 Siddhas who believed in no God but Śūnya, Vijnāna and Sukha. The Nāthas who believed in one God appear to be the spiritual descendants of the Siddhas and came to light about 1200 A. D. The famous Yogi Jnāneśvara, who lived from 1275 to 1296 A. D. traces his descent in his commentary on Śrī Bhagavadgītā from Śrī Ādinātha alias Jālandharapā.

stress on internal worship while Kaula worship is mainly external. In Samayācāra Dhyāna is in Sahasrāra-cakra and not in such lower cakras as Mūlādhāra and Svādhiṣṭhāna. It is interesting to note that Śrī Bappabhattsūri was well conversant with Kundalinīyoga as is clear from this hymn and recommends Dhyāna which is according to Samaymata and different from Kaula practices. In v. 8 he speaks of the identity between Śabdabrahma and Paramabrahma and in v. 10 gives the Sārasvata Mantra which is set forth as Mūlamantra in the Mantra Kalpa which follows. In the biography of Śrī Bappabhattsūri contained in Prabhāvakacaritra (vv. 738-739) it is stated that he practised Adhyātmayoga for 21 days fasting unto death and expired like a real Yogi, his soul leaving the body through Brahmarandhra or Daśamadvēra. He is the first Jain Āchāraya to refer to Kundalinī. Śrī Munisundarsūri (1436-1503 Vikrama era) also refers to Kundalinī and Dhyāna in Sahasrāra-cakra respectively in vv. 2 and 4 of his Sāradāstāvāṣṭaka. In the Mantrakalpa which follows the hymn, detailed Dhyāna in Ṣaṭcakra is described; Bṛhad Sārasvata Yantra and another Sārasvatayantra as also important Mantras with directions for worship of Sarasvatī are therein described.

APPENDIX 13

The 'Om Arhanmukhakamala-vāsini' etc. in Appendix 12 is the Mantra which is also incorporated in the hymn in this Appendix 13. This hymn is wrongly ascribed to an unknown Sādhvī Sivāryā merely from the words 'Sādhvī Sivāryā' occurring in v. 8. This is apparently a mistake as can be seen from the verse occurring after the said Mantra 'Candracandana-guṭim' etc. which mentions Hemasūri i. e. Hemacandrācārya as the Āchārya who prescribed the pill prepared from sandal-wood paste and pure camphor—the pill over which the said Mantra^x was to be recited for increasing the intellectual powers

^x Śrī Hemacandrācārya mentions the said Mantra in his Yogaśāstra ch. VIII v. 72 describing it as 'Pāpabhakṣiṇī Vidyā' i.e. Vidyā which destroys sins and sets forth the same verbatim in his commentary on the said verse.

of his pupils. It is clear therefore that the Stotra contained in this appendix which contains the same Mantra is the composition of Śrī Hemacandrācārya and not of any Sādhvī named Śivāryā. Each of the words Sādhvī, Śivā and Āryā is a name of Sarasvatī—see Sarasvatī-sahasranāma, Pancāṅgasaṅgraha (Benares, s. y. 1954). We give in the footnote Sārasvatavidyā by Śrī Bhadrabāhu* from the writer's collection for comparison. V. 7 of the hymn in this appendix 13 describes Jnānamudrā as a symbol of Sarasvatī instead of Viṇā, the other symbols being book, and two lotuses. The swan is mentioned to be the vehicle.

We have already described the life of Śrī Hemacandrācārya (see pp. 218–220). We may however add that about his time last of the Tāntrika Siddhas flourished and the Nātha cult was about to rise. His Yogaśāstra belonged to this transitional period when the people appreciated and valued miraculous powers but strongly disapproved of the Vāmācāri practices. The way had already been paved for this by Samayamata preached by Śrī Sankarācārya.

As an illustration of his faith in the efficacy of Mantra, we may refer the readers to his Kāvyaānuśāsana‡ where he mentions 'Pratibhā' or genius as the cause of poetical powers and says that it is of two kinds: (i) natural and (ii) acquired through Mantra by the grace of Māntric deity etc. He adds however that in the latter case also there is temporary or permanent removal of the veil of Karma showing that Māntric powers were not inconsistent with the Jain philosophy of Karma.

। श्री भद्रबाहुकृता सारस्वतविद्या ।

* “ॐ नमो भगवद्देवे सुयदेव्याए सव्वसुअमायाए बारसंगपवयण जणगीए सरस्मईए सच्चवयणि सुवन्नवज्जि ओअर २ देवि मम सरीरं पविस मुहं पविस सव्वजणमयहरीए अरिहंतमिरीए ॐ किरि २ मिहिरे मिहिरे नमः॥” लक्षत्रयजापेन वरदा भवति । महाव्रतधारिणा भाव्यं । पठितेन आदित्यवचो भवति ॥

‡ “प्रतिभास्य (काव्यस्य) हेतुः । सावरणक्षयोपशममात्रात्सह मा । मन्त्रादिरौपाधिकी ।” काव्यानुशासनम् ॥
अलंकारचूडामणिवृत्तिः—“मन्त्रदेवतानुग्रहादिप्रभवौपाधिका प्रतिभा । इयमप्यावरणक्षयोपशमनिमित्तैव ।
दृष्टोपाधिनिबन्धनत्वात्त औपाधिकीत्युच्यते ।”

APPENDIX 14

Appendix 14 contains 'Sārdāstavana' a Māntric hymn to Sarasvatī by Śrī Jinaprabhasūri whose life we have already described (see pp. 229–236). It is a beautiful hymn and may serve as an illustration of the great poetical powers of its author and his fondness for Mantras. As in the writer's copy of the hymn instead of 'श्रीन्द्रमुह्य०' in v. 4 the reading is 'श्रीन्द्रनन्दि०' there appears to be an allusion to the great Māntrika Indranandi. V. 7 describes a rosary, a lotus, a Viṇā or lute and a book as the symbols of Sarasvatī who is said to be residing in a lotus. It is expressly stated in v. 9 that the hymn contains a great Sārasvata Mantra which is probably this: "ॐ ऐं ह्रीं श्रीं वद २ वाग्वादिनि भगवति सरस्वति तुभ्यं नमः"

APPENDIX 15

The Devīstotra comprised in the 15th Appendix is probably composed by some non-Jain writer. It contains various names of Sarasvatī, Lakṣmī, Yoginī and others. It may be noted that the author identifies Devī with Jainēśvarī, Bauddhamātar and Jinamātar. It is easy to identify Jainēśvarī as Śrī Ambikā as she is described as riding on a lion.

✓ ŚRĪ AMBIKĀ

As the works in Appendices 16 to 21 relate to Śrī Ambikā, we shall offer a few preliminary remarks about her.

We have already shown that Śrī Ambikā has been worshipped by the Jains from very ancient times and that she is considered to be the Jain Āmnāya deity. Many have been perplexed as to why Śrī Ambikā is associated with the images of various other Tīrthaṅkaras although an attendant deity of the 22nd Tīrthaṅkara Śrī Neminātha. The reason is that she is the deity taken to represent the Jain Āmnāya as Tārā represents the Bauddha Āmnāya. Not only is she associated with other Tīrthaṅkaras but her images also are found installed in the temples of various other Tīrthaṅkaras—not merely in the temple of Śrī Neminātha. For instance, Śrī Jinaprabhasūri in his Vividhatirtha Kalpa on

p. 19 describes her as riding on a lion and guarding the Tīrtha of Mathurā and her image is actually found from the excavations of the Jain Stūpa at Mathurā (see p. 256 ante). In the same work in Ahicchatrā Kalpa p. 14, it is stated that there was an image of Śrī Ambikā in Ahicchatrā in the vicinity of the fort riding on a lion with the image of Śrī Neminātha on her crown. Now it should be noted that Ahicchatrā is a Tīrtha sacred to Śrī Pārśvanātha. The same work mentions that images of Śrī Ambikā were found installed in the temples at Hastināpura, Pratiṣṭhānapura alias Paiṭhaṇa, Girinār, Dhīmpurī and several other places. Even this day in the famous temple of Śrī Antarikṣa Pārśvanātha at Śrīpura alias Śirpur is an image of Śrī Ambikā accompanied by an image of Kṣetrapāla.* Similarly in the famous Serisā Pārśvanātha Tīrtha (near Kalol) is found when the Tīrtha was recently discovered a large stone-image of Śrī Ambikā in a sitting posture carrying on her crown the image of Śrī Neminātha holding a bunch of mangoes in her left hand and supporting a child on her lap with the right. Another child stands beside her and the lion crouches at her feet. In Prabhāsa Pātana also, in the temple of Śrī Dādā Pārśvanātha is an image of Śrī Ambikā—see fig. 87 'Bhārt-nām Jain Tīrtho'. She is shown as sitting under a mango tree, carrying on her crown an image of Śrī Neminātha and holding a bunch of mangoes in her right hand and supporting with the left a child on her lap. Another child stands on her right. Her vehicle the lion is also shown. From an inscription it appears that an image of Śrī Ambikā was formerly installed in the temple of Śrī Candraprabha at Prabhāsa Pātana. In the famous Ellora caves there are several carved images of Śrī Ambikā. One large image going under the name

* 'Raivatakagirisaṅkṣepa', Vividhatīrthakalpa and 'Śātruñjayamāhātmya' II, 13 give names of several Kṣetrapālas and other deities presiding over various parts of the Mt. Girnār. They are associated with Śrī Ambikā in the Jain narrative literature. Some of them are Kālamegha, Meghanāda, Girividāraṇa, Kapāṭa, Siṃhanāda, Khodika, Raivat, Siddhavināyaka, various Rudras, Gomejha Yakṣa and Mahājwālā.

of Indrāṇi is that of Śrī Ambikā. She is shown in a sitting posture shaded by a fine mango tree carrying an image of Śrī Nemināth on her crown. Her right hand which is mutilated probably held a bunch of mangoes and the left hand supports a child on her lap. There is a lion crouching at her feet and attendants round about her. Peacocks are shown on the top of the mango tree indicating the advent of spring.

In several metal images of Śrī Ṛṣabhadeva is associated the image of Śrī Ambikā instead of Śrī Cakreśvari. Sometimes she is associated with the images of Śrī Pārśvanātha and other Tīrthaṅkaras also. This can be explained only on the ground of Śrī Ambikā being the representative Jain Āmnāya deity. This proves the antiquity and popularity of the worship of Śrī Ambikā.

In the hymns (Appendices 16-18, 20-21) and Śrī Ambikā Mantra Kalpa (Appendix 19) Ambikā is variously described. She is said to have two, four or more arms and to be of golden colour or of red, white or dark-blue colour. We may state here that one and the same deity is differently described as the object desired to be achieved differs. Broadly speaking a Sādhaka may contemplate on the Sāttvika (tranquil or peaceful) form of the deity if the object desired by him is Sāttvika (peaceful i. e. devoid of passion); similarly the form is Rājasa (imbued with grandeur) or Tāmasa (terrific), if the object desired by the Sādhaka is Rājasa (imbued with passion or desire) or Tāmasika (malignant).^{*} Generally the 'Sāttvika' form of a deity is described as having two arms and being in a sitting posture, the Rājasa as having four arms and being in a standing posture and the Tāmasa as having many arms and actually in such action as is in

^{*} यथा कामं तथा ध्यानं कारयेत्साधकोत्तमः । क्रूरकार्येषु सर्वेषु ध्यानं वै तामसं स्मृतं ॥२४॥

बश्यं विद्वंषणे स्तंभे राजसं ध्यानमीरितम् । सात्त्विकं शुभ कार्येषु ध्यानभेदःसमीरितः ॥२५॥

बालसूर्याशुसंकाशं राजसं ध्यानमुच्यते । सात्त्विकं श्वेतवर्णं च कृष्णं (वर्णं)तामसमुच्यते ॥२६॥

consonance with the object desired by the Sādhaka. In Sāttvika Dhyāna the colour of the deity is white, in Rājasa red-sometimes yellow, and in Tāmasa dark blue or black. Peace, knowledge, selfless devotion or propitiation of the deity are Sāttvika objects; prosperity happiness and other worldly objects imbued with passion or desire are Rājasa objects; and adversely affecting an enemy etc. are Tāmasa or malignant objects. Further, some deities are by their nature Sāttvika some Rājasa, some Tāmasa and some have all the three qualities. † A Sādhaka makes his selection accordingly. This is the reason why special deities are recommended for worship for special objects (See Śrīmad Bhāgavat Sk. II, Adh. III, vv. 2-9 specially 6 & 7). This accounts for variations in the 'Svarūpa' or form of a deity. We think the deciding factor in ascertaining the nature of a particular deity or its image is the actual impression created on the mind of the Sādhaka. Amongst postures symbols and colours of a deity the most important factor is the colour as it most affects the Dhyāna.

As some deities have all the three qualities and some only one of them any inference as to worship of a particular form of a deity being ancient or otherwise which does not take into account the original conception as to the nature of the deity is likely to be erroneous. Śrī Ambikā is not only a Śāsanadevī but as already stated is also the Jain Āmnāya deity and as such has been invoked for achieving various objects from time to time.* She is therefore conceived

† See 'Saptaśatī Prādhānika Rahasya' and 'Saptaśatī Vaikṛtika Rahasya'.

* See p. 259 ante for the various purposes for which Śrī Ambikā was invoked from time to time. Śrī Haribhadrasūri invoked her for obtaining success in the debate against Buddhists who were aided by their patron-deity Tārā. In 'Anubhavasiddha-mantra-dvātriṃśikā' ch. IV vv. 7 to 15 is described the worship of Śrī Ambikā for divination. See also Śrī Ambikā's Mantra for divination at p. 93 Appendix 19, where she is invoked as Vāgīśvarī. Her various Mantras in the said Appendix 19 show the various purposes for which she is invoked. Instead of the last Mantra on p. 93 Appendix 19 Pancaparamēṣṭi Mahāmantra Yantra Bṛhatkalpa gives this Mantra: 'ॐ ह्रीं रक्ते २ महारक्ते २ सौं हम्ब्र्युं २ शासनदेवि एहि २ अवतर २ स्वाहा ॥'

to possess all the three qualities. It would not therefore be correct to state in relation to her that worship of her two-armed form is ancient and that of other forms is otherwise, merely because only two-armed ancient images have come to light. Having regard to her nature as originally conceived it is equally possible that further discoveries may bring to light her other ancient forms also. In regard however to deities like Sarasvatī originally conceived as possessing a single quality viz. Sattva it can be stated without fear of contradiction that her two-armed form is ancient both because that is the only ancient form yet discovered and specially because that is the form in conformity with her Sāttvika nature as originally conceived.

We would now refer the readers to Ācāradinakara Vol. II pp. 207-209 where Bhagavatīmandala is described to be worshipped as a part of installation ceremonies of goddesses. As it is a Yantra common to goddesses including Śrī Ambikā it furnishes a clue to her 'Parivāra' which includes 8 Mātṛkās, 16 Vidyādevīs, 64 Yoginīs, 52 Vīras, 8 Bhairavas, 10 Dikpālas, 9 Grahas, Kṣetrapāla and others.

Śrī Ambikā is also known as Kuṣmāṇḍī, Āmrakuṣmāṇḍī, Kuṣmāṇḍinī, or Kohaṇḍī because her 'Vimāna' or heavenly abode is named Kuṣmāṇḍa or Kohaṇḍa—see Vividhatīrtha Kalpa p. 107. Śrī Durgā is also known as Kuṣmāṇḍī because it is said that she is fond of the offering of Kuṣmāṇḍa i. e. a red pumpkin or gourd, which however is not the case here. Śrī Ambikā is called Āmrakuṣmāṇḍī referring to the mango in her hand, perhaps to distinguish her from Śrī Durgā.

APPENDIX 16

We would now consider the question of the authorship of the hymn in Appendix 16. As the name Ambāprasāda is cleverly introduced in the last verse of the hymn, it is presumably by some Ambāprasāda. We have referred to the minister Ambāprasāda who was cured of a snake-bite by Vādī Devasūrī on Mt. Abu—see foot-note at pp 217-218 ante. There has been another Ambāprasāda, the younger brother of the Digambara Jain poet Amarakīrti. The latter

refers to him as Ambāpasāya i. e. Ambāprasāda in his Apabhraṃśa work 'Chhakammuvaeso' written in 1247 Vikrama era.

As there is in v. 3 of the hymn a reference to Kuberanagara (perhaps Kodināra),* which is the name of the town where Śrī Ambikā resided with her husband according to the Śvetāmbara tradition, we think the author of the hymn is very probably the said Śvetāmbara minister Ambāprasāda. It may also be noted that the Digambara tradition describes Śrī Ambikā to be of dark-blue (Harita) colour which colour not mentioned at all in the hymn although her three different Dhyānas are given where Śrī Ambikā is to be contemplated as of three different colours. None of the said colours is 'Harita' or dark-blue.

APPENDICES 17 TO 19

The hymns in Appendices 17 and 18 do not furnish any clue as to their authorship. The Mantra incorporated in the hymn in Appendix 17 is one of Śrī Ambikā's Mantra set forth in Appendix 19. We think Appendix 19 is a continuation of the work contained in Appendix 18 and the two verses given in the beginning of Appendix 19 are the verses containing 'Falaśruti' of the hymn in Appendix 18 and are followed by the Kalpa of Śrī Ambikā containing her various Mantras meant for achieving various objects. As the hymn in Appendix 21 by Śrī Jineśvarasūri, the pupil of Śrī Jinapatisūri, does not give the full-grown Mantra incorporated in the hymn in Appendix 17 the latter hymn is probably later in date than the hymn in Appendix 21.

According to v. 1 of the hymn in Appendix 17 Ambikā is the protectress of all the creatures of the world and according to v. 8 the protectress of all the Jain temples. Both the hymns in Appendices 17 and 18 and the first Mantra on p. 93 describe her as devoted to the Jain Faith. The correct readings in the 2nd half of

* See Vividhatīrtha Kalpa, Ambikādevī Kalpa p. 107 which mentions Kodināra, also Śatruñjayamāhātmya II, 13 which mentions Kuberanagara.

v. 3, Appendix 17 are 'द्रौ द्रुतं द्रव्य० etc.' and 'द्रौ द्रुहि० etc.' and that in the 15th line of the hymn in Appendix 18 is '० ह्रींकारकोकारबीजान्विते ।'

APPENDIX 20

The author of the hymn contained in this appendix is Vastupāla the famous minister of Vīradhavalā. The author styles himself in v. 10 a poet, the minister of the sovereign of Gujarāt and the ocean of learning or Sarasvatī. He addresses Śrī Ambikā as Kūṣmāṇḍī, Ambā, and Sarasvatī. The former term has already been explained. He describes Ambikā as always prompt in the protection of the Jain fold. The author in a poetic fancy says that Lakṣmī who resides in lotus would never leave the devotee who bears in his heart the lotus-feet of Śrī Ambikā, being fond of the advantageous and novel lotus-abode in the form of Śrī Ambikā's feet. Ambikā's Vāhana the lion is also praised. She is said to be holding a bunch of mangoes before her as a token of the fruit to be reaped immediately by her worship. In the 7th verse are mentioned the eight dangers which are warded off by Śrī Ambikā. The author compares the hymn to a song to be sung in a circular dance. According to Rājasekhara's *Çaturviṃsatī-prabāṇḍha* Śrī Ambikā and Śrī Kapardiyakṣa* were the patron-deities of Vastupāla and Tejapāla.

Vastupāla was not only a great minister but also a great general and defeated King Saṅkha of Lāṭa when the latter invaded Cambay as also the Muhammedan chieftain named Hammīra alias Mojḍin Sultān, who may perhaps be identified with Mahomed Ghorī, * near Mt. Abu. Besides, he was a scholar, a critic and an accomplished poet whose Sūktis i.e. (pithy memorial verses) are found in Sārangadhara's and Jalhana's anthologies. He wrote *Naranārāyaṇānanda Mahākāvya* in the style of great classical poems. The wonder is that even with his varied

* *Śatruñjayamāhātmya* describes Kapardiyakṣa to be of golden colour riding on an elephant and carrying in his four hands a rosary, a goad, a noose and a citron (bijoru) and having the banyan tree as his resort. Kapardiyakṣa Kalpa mentions a long purse instead of the rosary.

activities he found time to copy manuscripts himself (see the Ms. of Dharmābhyudaya Kāvya dated 1290 Vikrama era in the handwriting of Vastupāla preserved in Srī Sāntinātha Bhandāra at Cambay). He was a great patron of literature and rewarded poets and men of letters so liberally that he earned the title of Laghu Bhoja or II Bhoja. For his scholarship he was compared to the famous Hemacandrācārya. His munificence was without distinction of caste and creed. He spent large sums in building Jain and Saiva temples and even mosques for Muhammedans and libraries, rest-houses, alm-houses, wells, step-wells, tanks, lakes etc. for the public.

He established three big libraries or Pustakabhandāras at the huge cost of Rs. 18 crores. It is however the Delwārā temples, of which Luṅigavasabi was built by Tejapāla the brother of Vastupāla at a cost of crores of rupees, which have earned for the brothers lasting fame.

Vastupāla was born of Aśvarāja and Kumāradevī, the latter being the daughter of Dandapati Ābhu. The exact date of his birth is not known but it must be circa 1230 as it is reported that he performed a pilgrimage to Satruñjaya with his father in 1249 Vikrama era. He had two wives Lalitādevī and Vejaladevī of whom the former being very clever was frequently consulted by Vastupāla even on intricate state-problems. He had a son Jaitrasimha by Lalitādevī who was appointed the governor of Cambay in 1279 during the lifetime of Vastupāla. He died on Māgha Sud 5th 1296 Vikrama era. He had earned 24 titles such as Sarasvatī-Kanṭhābharaṇa i.e. the neck-ornament of Sarasvatī etc. His ideals may be summed up in a single verse of his own:

“शास्त्राभ्यासो जिनपदनतिः संगतिः सर्वदार्थैः
सद्गुणानां गुणगणकथा दोषवादे च मौनम्।
सर्वस्यापि प्रियहितवचो भावना चात्मतत्त्वे
सम्पद्यन्तां मम भवभवे यावदाप्तोऽपवर्गः ॥

APPENDIX 21

This hymn is by Srī Jineśvarasūri. We think it must be by the 2nd Jineśvarasūri the pupil of Srī Jinapatisūri and not the famous

debater Jineśvarasūri who defeated Caityavāsis in 1080 Vikrama era. He was born of Nemicandra Bhāṇḍāgārika and Lakṣmī at Maroṭa in 1245 Vikrama era and was named Ambada. Nemicandra accepted the Jain Faith at the instance of Śrī Jinapatisūri and thereafter wrote Saṭṭhisaya Payaraṇa. Śrī Jinapatisūri initiated Ambada in 1255 and named him Vīraprabha. He was ordained Ācārya in 1278 at Jālore by Sarvadevasūri and named Śrī Jineśvarasūri. He wrote Śrāvaka-dharma-vidhi in 1313 and a commentary thereon in 1317. He died in 1331 Vikrama era. His pupils were Śrī Pūrṇakalaśagaṇi (see ante pp. 228-229) Lakṣmītilaka, Abhayatilaka, Candratilaka, Jinaprabodhasūri (who wrote Mantrārādhana-vidhi), Jinaratnasūri, Devamūrti, Vivekasamudra-gaṇi and Sarvarājagaṇi—all learned scholars and writers.

ŚRĪ CAKREŚVARĪ

The hymns in both the Appendices 22 and 23 are in praise of Śrī Cakreśvarī. We shall therefore offer some remarks regarding her iconography. Śrī Cakreśvarī has the eagle for her vehicle and according to Nirvāṇakalikā has eight arms. She shows in her four right hands Varadamudrā, an arrow, a discus, and a noose and in her four left hands a bow, a thunderbolt, a discus and a goad. A marble image with eight arms showing the said symbols is installed in a niche to the left of the flight of steps leading to Caumukha's Tūṅka (group of temples) on Mt. Śatruñjaya. Another image of Śrī Cakreśvarī with four arms is installed in the temple of Śrī Vastupāla and Tejapāla on Mt. Girnār. She holds in both her upper hands discuses and in the lower right hand a garland and in the lower left hand a conch. Her Vāhana viz. the eagle is also shown. The unmistakable symbol of Śrī Cakreśvarī is the discus; sometimes it is shown in her two hands and sometimes in all the four. One can easily understand that these are variations made to give different artistic effects by the sculptor, whose only restriction is that he shall not omit the distinguishing symbol of the deity viz. the discus in the case of Śrī Cakreśvarī and the bunch of mangoes and a child in the case of Śrī Ambikā.

Sri Cakreśvarī is a Śāsanadevī (the deity presiding over the fold) being the attendant deity of Śrī R̥ṣabhadeva the first Tirthaṅkara, so the other 23 Śāsanadevīs are her companion–deities. She being one of the deities presiding over Sūrimantra, Pancaparameṣṭi Mantra and Siddhacakrayantra, the other presiding deities thereof are her allied deities. Besides the deities usually shown in the Yantra of a deity viz. 16 Vidyādevīs, 10 Dikpālas, 9 Grahas and Kṣetrapāla,* Śrī, Hrī, Dhṛti, Kīrti, Buddhi and Lakṣmī are shown in her Yantra in the collection of the writer as her Aṅgadevatās. 64 Yoginīs and 52 Vīras and 8 Bhairavas are the usual attendants of a Devī as can be seen from Bhagvatī–Mandala given at pp. 207 to 209, Ācāradinakara. Śrī Siddhacakrayantra mentions Jayā, Vijayā, Jayantī, Aparājitā, Jṛmbhā, Mohā, Stambhā and Andhā as the eight attendant deities and Pūrṇabhadrā, Mānībhadrā, Kapila and Piṅgala as four Vīras and Śrī Vimalaśvaradeva as one of the principal presiding deities. This will furnish sufficient information as to Śrī Cakreśvarī's 'Parivāra'.

APPENDICES 22 and 23

Both the hymns of Śrī Cakreśvarī in the Appendices 22 and 23 show her 'Vāhana' to be the eagle and describe her distinguishing symbol viz. the discus as wielded by her. The second hymn suggests that she wields discuses in her two hands and states that with the other two she holds a lotus and a fruit.

The hymn in Appendix 22 is by the famous Māntrika Āchārya Śrī Jindattasūri whose life we have already described—see pp. 214–216 ante. × We have already made our remarks as to the authorship of the

* At page 181 Ācāradinakara Vol. II are given several current names of Kṣetrapāla viz. Kālamegha, Meghanāda etc. and he is described to be of 5 colours namely Kṛṣṇa (black), Gaura (white) Kāñcana (golden) Dhūsara (dusky) and Kapila (variegated).

× In his hymn 'Siggham avaharau viggham' he invokes Śrī Cakreśvarī thus:—

“चक्रेश्वरि चक्रधरा विह्विपहरिउच्छिन्नकंधरा धणियं ।

सिक्खसरणलग्गसंघस्स सब्बहा हरउ विग्घाणि ॥८॥”

hymn in Appendix 23 while discussing the works contained in Appendix 5.

There are some incorrect readings in the said hymn which can be properly corrected if a correct manuscript can be obtained. As regards the hymn in Appendix 22, we would only note that the opening words of the 4th line of v. 1 should be 'मातर्मां तनयं' instead of 'मात मन्ति नयं ।'

APPENDEX 24

The hymn given here enumerates the names of 64 Yoginīs. Another set of 64 names of Yoginīs is given in vv. 19 to 28, Adh. 146 Agnipurāṇa, which describes them as belonging to the eight families of Mātrkās, a set of 8 Yoginīs being related to each of the eight Mātrkās. Still another set of 64 names is given at pp. 67-68 Mantramahodadhi and at p. 85 thereof is given the 91 lettered Mantra + of Yoginīs, which is really an invocation for protection on offering being made to Yoginīs. We may refer the readers to the foot note on pp. 233-4 ante for other sets of names of 64 Yoginis. Rudrayāmala (Uttaratantra) contains a hymn to Yoginī (see pp. 263-64), but there Yoginī is the deity connected with Mūlādhāra-cakra. Nirvāṇakalikā (p. 5) gives the Jain Mantra * to be recited on offering oblation to

+ "ऊर्द्धं ब्रह्मांडतो वा दिवि गगनतले भूतले निष्कले वा
पाताले वा तले वा सलिल पवनयोर्यत्र कुत्र स्थिता वा ।
क्षेत्रे पीठोपपीठादिषु च कृतपदा धूपदीपादिकेन
प्रीतादेव्यः सदा नः शुभमलिविधिना पातु वीरेन्द्रवंशाः ॥ यां योगिनीभ्य स्वाहा ॥"

* योगिन्यो भीषणा रौद्रा देवताः क्षेत्ररक्षकाः ।
आगत्य प्रतिगृह्णन्तु जिनेष्टानुविधासिनः ॥१॥
ये रुद्रा रुद्रकर्माणो रौद्रस्थाननिवासिनः
सौम्याश्चैव तु ये केचित् सौम्यस्थाननिवासिनः ॥२॥
सर्वे सुप्रीतमनसः प्रतिगृह्णन्स्वित्स्वमं बलिम् ।
सिद्धिं यच्छन्तु नः क्षिप्रं भयेभ्यः पान्तु नित्यशः ॥३॥

Here is a Mantra of 64 Yoginis from the writer's collection:

"उँ ऐँ ह्रीँ श्रीं क्लीँ ह्रौँ चतुःषष्टियोगिनीभ्यो नमः ॥"

Yoginīs, which is also an invocation for protection and success. The Yoginīs are there described as protectresses of land (Kṣetra-rakṣakās), which suggest that they are subordinate to Kṣetrapāla who is the chief warden of the land. 52 Vīras usually mentioned along with 64 Yoginīs are also described as protectors of land and may be identified with the different Kṣetrapālas of different places. Sometimes Kṣetrapāla is considered to be Vīrādhivīra or the Chief of Vīras in which case Vīras would be taken to be subordinate to him. According to Nirvāṇa-kalikā it would appear that most of the Yoginīs are in their nature terrific while only some are peaceful. Śrī Jwālamālinīstotra (Appendix 25) also refers to Yoginīs. There is a hymn of 64 Yoginīs noted in Jain Granthāvali.

Agnipurāṇa as stated above relates 64 Yoginīs to 8 Mātṛkās; Durgāsaptaśatī describes Mātṛkās as companion-deities of or emanations from Śrī Candikā (See Adh. X vv. 5-6). Yoginīs are thus related to Śrī Candikā or Śrī Durgā or Nārāyaṇī mentioned in the hymn. That the worship of Yoginīs was prevalent in ancient times will be apparent from the fact that Agnipurāṇa Adh. 52 refers to their idols. At Ujjain, the ancient capital of the famous King Vikramāditya whom legends describe as having controlled Vīra Vetāla and 64 Yoginīs and as having obtained boons from his patron deity Harasiddhi, there are to be found ruins of a temple said to be of 64 Yoginīs. This shows that the worship 64 Yoginīs is very old. The fact that their Pīṭhas are said to be at Delhi-Yoginīpura, Ajmer and Broach besides Ujjain (see p. 234 ante), all which places have been capitals of powerful kingdoms in the past, leads one to conjecture that the King used to worship them and 52 Vīras for protection of their kingdoms especially during wars and epidemics or public calamities. In a hymn of 15 verses commencing with the words "Jaga-gaja-vasaṇīṇam" etc. in the collection of the writer they are praised for removal of various diseases and their Maṇḍala or diagram of 64 squares containing figures 1 to 64, the total vertically horizontally and diagonally being 260—is described.

Savarīpā (657 A. D.) was the originator of Vajrayoginī cult where the deity worshipped is of red colour (see p. 92 ante). This would suggest that Vajrayoginī cult where the deity worshipped is of other colours existed prior to Savarīpā. Luipā (669 A. D.) introduced Yoginī Sañcaryā (see p. 91 ante). This shows how Yoginī worship spread amongst Buddhists. It should be noted however that in the said Buddhist Tantra Yoginī is not one of the 64 Yoginīs nor for the matter of that the principal Yoginī but, judged from her Dhyāna and Mantra, can be identified with Chinnamastā, one of the 10 Siddha Mahāvidyās of Hindu Tāntrikas.

The Yoginīs were however well-known during the time of Śrī Jinadattasūri and Śrī Hemacandrācārya as can be seen from their biographies (see p. 214 and 220 respectively).

We may note here an anecdote relating to the 64 Yoginīs who having taken possession of the 64 Koṭhās or towers of the new fort built round Ahmedabad by Sultan Ahmed Shah harassed him. The Sultan having not been relieved of his trouble inspite of various remedies was advised to seek the aid of a Jain Āchārya named Śrī Ratnasimhasūri, a pupil of Śrī Jayatilakasūri of Bṛhat Pauśālika branch of Tapāgaccha. Śrī Ratnasimhasūri employed the mystic diagram of 65 formed with the figures 1 to 25 representing the 24 Tīrthaṅkaras and the Sangha which is considered to be the most sacred body next to the 24 Tīrthaṅkaras and therefore taken to be represented by the figure 25. The Sultan was thus saved from the harassment of the 64 Yoginīs. *

As Yoginītantra gives Śrī Padmāvati's Mantra for foreseeing the future through dreams ('ॐ ह्रीं पद्मावतीदेवि त्रैलोक्यवार्ता कथय २ स्वाहा ॥' to be recited daily for 2 years), it probably considers Padmāvati to be a Yoginī. Similarly Mahāyakṣiṇī Tantra gives Śrī Padmāvati's Mantra ('ॐ क्लीं पद्मावती स्वाहा') calling it Aṣṭamahāsiddhi-Yakṣiṇī-Prayoga, which

* See Vṛddha Tapāgaccha Pattāvali and also the hymn Caturviṃśati-Jina-stotram relating to the diagram of 65 commencing with the words "भादौ नेमिजिनं नौमि ।"

would suggest that Śrī Padmāvati is also considered to be Aṣṭamahāsiddhi–Yakṣiṇī. The latter Tantra also gives Śrī Cakreśvari's and Śrī Kalikuṇḍa's Mantras. This shows the popularity of these deities.

Verses 9 to 12 with better readings are given in the footnote below from a copy of the hymn in the writer's collection. * Nothing is known about the author of the hymn.

APPENDIX 25

This appendix contains the famous Jwālāmālinīstotra and a hymn in praise of the Mantrabīja Hrīṃkāra which is known as Māyābīja. We have offered our remarks regarding the worship of Jwālāmālinī at p. 264 ante. Jwālāmālinī is believed to be a Vidyā counter to all Vidyās and Mantras of the opponent. She is said to cure all diseases, to ward off all kinds of snakes and untimely and unnatural death and above all to counteract the adverse influence of planets and ward off evil spirits of all kinds: she is described as Mahāvaśī—great subduing or controlling power. When appropriately invoked she would fascinate and charm all. The text of the hymn is according to the Śwetāmbara tradition. Although it is slightly different from that in Indranandi's Jwālīnī–Kalpa and Vidyā-nuśāsana, its author is very probably Indranandi. The hymn being popular has been much imitated. The Mālāmantra at pp. 12–13 (Appendix 1), the hymn at p. 13–14 and the hymn at pp. 19–20 (Appendix 3) viz. Śrī Padmāvati–āhvāna–stava may be compared for the purpose. Non-Jain hymns similar to this hymn are Sudarśana–Kavaca–stotra and Narasiṃha Sudarśana–Kavaca–stotra.

- * चतुःषष्टिः समाख्याता योगिन्यो मे वरप्रदाः ।
 त्रैलोक्ये पूजिता नित्यं देवदानवयोगिभिः ॥१॥
 चतुर्दश्यां तथाष्टम्यां संक्रान्तौ नवरात्रिके ।
 यः पठेत् पूजयेन्नित्यं तस्य विघ्नं प्रणश्यति ॥१०॥
 राजद्वारे च संग्रामे तथा च रिपुसंगमे ।
 अग्निचौरभयं नास्ति तत्रसंस्थोऽपि मुच्यते ॥११॥
 स्मृत्वा नारायणीं देवीं सर्वोपद्रवनाशिनीं ।
 प्रातर्मध्याह्नसंध्यायां पठितव्यं विचक्षणैः ॥१२॥

The diagram given after Śrī Māyābīja-stotra is only one of the several Yantras. Śrī Jwālāmālīnī current among Jain Māntrikas.

As regards the second hymn, we have to note that the text requires to be corrected with the aid of a good manuscript. Śrī Hemacandrācārya, in his Yogaśāstra (VIII, vv. 47-56), has described the Sādhanā of Hrīmkāra. It is one of the Mantras of Śrī Padmāvati. It is the principal Mantrabīja worshipped by Śāktas who call it Devī-Praṇava and consider it perhaps more sacred than even Omkāra. § According to the famous Kalyāṇavṛṣṭistava the Vedas declare Hrīmkāra alone to be the name of Tripurasundarī⁺. It is called Saktibīja, Trilokībīja, Ādimantra, Ātmabīja, Parameṣṭībīja and Siddhavidyā. The hymn describes the three kinds of Dhyāna viz. white, red and yellow for achieving different objects. Nothing can be said about its authorship but perhaps the words 'Saubhāgyalakṣmī and Mahodayapadam' occurring in vv. 13 and 16 respectively may furnish a clue. We would only state that there did live one Udayaprabhasūri the preceptor of the famous author of Syādvādamāñjarī circa 1300 Vikram era if one is inclined to read his name in the phrase 'Mahodayapadam.'

APPENDIX 26

The correct title of the hymn contained in this Appendix would be "Śrīvidyā-garbhatotram", as the hymn like the famous Kalyāṇavṛṣṭistava includes the 15 syllabled Śrīvidyā formed by taking the initial syllables of the verses 3 to 17, but the initial letter of v. 17 should be 'Hrīm' and not 'Śrīm'. V. 3 expressly mentions Pancadaśākṣarī.

§

विययीकारसंयुक्तं वीतिहोत्रसमन्वितम् ।

अर्धेन्दुलसितं देव्या बीजं सर्वार्थसाधकम् ॥१८॥

एवमेकाक्षरं ब्रह्म यतयः शुद्धचेतसः ।

ध्यायन्ति परमानन्दमया ज्ञानाम्बुराशयः ॥१९॥

—श्री देव्यथर्वशीर्षम् ।

+

'ह्रींकारमेव तव नाम गृणन्ति देवाः

मातङ्गिकोणनिलये त्रिपुरे त्रिनेत्रे ।' इत्यादि

The initial syllables of the verses 1 and 2 viz. Hrīm and Srīm are additional Mantra-bījas at the beginning of the Pancadaśākṣarī Vidyā proper. Such an addition is technically called 'Sirah' or the head of the Mantra or Vidyā. The Upāsanā of Srīvidyā gained greater currency because the same was set forth together with the relative diagram Śrīcakra by Srī Sankarācārya in his hymn Saundaryalaharī (See vv. 1, 11 and 32* and Kameśvarasūri's commentary on the same). The addition of Ramābīja i.e. Srīm at the end converts Pancadaśākṣarī into Śodaśākṣarī Srīvidyā †. When out of the three Khaṇḍas of Pancadaśākṣarī the first Khaṇḍa is 'Ha Sa Ka La' instead of 'Ka E I La' it is called Lopā-mudrā or Hādī Vidyā as it begins with the syllable 'Ha', the other being called Kādī as it begins with the syllable 'Ka'. Tripurasundarī with 15 Nityās preside over Śodaśākṣarī or the 16 syllabled Srīvidyā which forms the basis of the Samaya mode of worship.‡

§ Srī Devyatharvaśīrṣopaniṣad describes Pañcadaśākṣarī Srīvidyā, Bahvṛcopeniṣad refers to Srīvidyā and Tripurātāpinī and Bhāvanopaniṣad describe Śrīcakra.

* शिवः शक्तिः कामः क्षितिश्च रविः शीतकिरणः
स्मरो हंसः शक्रस्तदनु च परामारहरयः
भमी हृल्लेखाभिस्तिसृभिरवसानेषु घटिता
भजन्ते वर्णास्ते तव जननि नामावयवताम् ॥३२॥

† See all the hymns in 'Śrī Lalitāstavanamaṇimālā' (published by Nirṇayaśāgara Press) which contain the 16 syllabled Srīvidyā formed by putting together the initial syllables of the 16 verses of each of the hymns.

‡ "The first four syllables of the Śodaśākṣarī constitute the first Khaṇḍa, relating to Agni, representing Kriyāśakti, the Jāgrat state, the Viśva-vṛtti and Tamoguṇa. The next five syllables constitute the second Khaṇḍa, relating to Sūrya, representing Icchā-śakti, the Svapna state, the Taijasavṛtti and Rajo-guṇa. The Hrī-lekhā between the two represents the Rudra-granthi. The next three syllables constitute the third Khaṇḍa relating to Soma, representing Jñāna-śakti, the Suṣupti state, the Prājñā-vṛtti and Sattva-guṇa. The Hrī-lekhā between the second and third Khaṇḍas represents the Viṣṇu-granthi. The fourth Khaṇḍa of one syllable, known as the Candra-kalā, which should be imparted by the Guru, is implied after the three aforesaid Khaṇḍas. The Hrī-lekhā between the third and fourth Khaṇḍas represents the Brahma-

APPENDIX 27

Referring to the hymn in this Appendix its language besides being ungrammatical is so poor that the hymn cannot be ascribed to any person of note. Some one named Śrīdharācārya is mentioned as the author.

APPENDIX 28

Referring to Padmāvati Kavaca in this appendix, we may repeat that such hymns have probably been composed on account of the eagerness of some one to have complete Pancāṅga of Śrī Padmāvati (see v. 14 which mentions the object 'साङ्गता जायते देवि ! नान्यथा गिरिनन्दिनि !'). It is probably written after the composition of Padmāvati-sahasranāma-stotra (see v. 13). The author is probably a non-Jain as would appear certain from v. 14 which says that it was narrated by Nandi and was being published to Girinandinī i. e. Pārvatī. The opening words (v. 1) lead us to the same conclusion.

APPENDIX 29

This appendix contains Sūrividyā-stotra. It is in praise of the deities presiding over the 5 Pīṭhas of Sūrividyā alias Sūrīmantra on which we have offered our remarks at pp. 161-165 ante. The first 3 Pīṭhas are presided over by female deities and are therefore called Vidyās. They are Sarasvatī, Tribhuvanaswāminī and Śrī alias Lakṣmī. The fourth Pīṭha is presided over by Yākṣarāja Gaṇipīṭaka and is therefore a Mantra. The fifth Pīṭha having Indras as principal presiding deities is also Mantra. It is also presided over by 16 Vidyādevīs, 24 Yakṣas and 24 Yakṣiṇīs being the attendant deities of the 24 Tīrthaṅkaras. It being the best of Mantras and having a number of deities presiding over it is called Mantrādhirāja. That a bath with a little water is allowed and the Sādhanā is directed to put on a fine piece of cloth (v. 17) shows that exceptions were being made by Sādhus for Māntric Sādhanā. In Sūrīmantrārādhanavidhi by Śrī Devendrasūri, published

granthi." PP. 126-127, Saundarya-Laharī, by Pt. S. Subrahmaṇya Śāstrī and T. R. Śrīnivāsa Ayyaṅgār.

by Śrī Prītivijayaji, this very hymn is given and ascribed to Śrī Mānadevasūri, but it is not his. Śrī Mānadevasūri's genuine Sūrimantra-stotra is given by us in Appendix A hereto. This Mānadevasūri composed Laghuśāntistava contained in Appendix 31. We would here reproduce verse 11 from a hymn of Śrī Gautamaswāmi by Śrī Vajraswāmi published at p. 114, Jainstotrasandoha, Pt. I, as it mentions all the presiding deities of the five Pīṭhas in their proper order in a single verse and shows that Sūrimantra was the same in the time of Śrī Vajraswāmī.

‘श्रीमद् गौतमपादवंदनरुचिः श्री वाङ्मयस्वामिनी
मर्त्यक्षेत्रनगेश्वरी त्रिभुवनस्वामिन्यपि श्रीमती ।
तेजोराशिरुदात्तविंशतिभुजो यक्षाधिपः श्री सुरा-
धीशाः शासनदेवताश्च ददतु श्रेयांसि भूयांसि नः ॥

We have already referred to Śrī Vardhamāna-Vidyā Kalpa of Śrī Vajraswāmī incorporated by * Śrī Siṃhatilakasūri (1322 Vikrama era) pupil of Śrī Vibudhacandrasūri in his Vardhamāna-Vidyā Kalpa as the 3rd chapter thereof. We may note here that the correct reading instead of ‘दुह्य’ in the 4th verse of the hymn is ‘तह्य’ ।

APPENDIX 30

This appendix contains Anubhavasiddhamantra-Dvātriṃśikā about which we offered a few remarks at pp. 159-161 ante, particularly about its connection with Vidyāpravādapūrva and Jain Āgamas and in relation to the probable date of the work, the lower limit of which has been stated to be the 7th century A. D. The upper limit of its date would be the date of Bhadrāguptācārya and Vajraswāmī i. e. the 1st century A. D. As promised there we shall now make further observations especially on the question of the priority between Hemacandrācārya's Yogasāstra and Subhacandrācārya's Jñānārṇava alias Yogapradīpa.

* Besides Vardhamānavidyā-Kalpa Siṃhatilakasūri wrote in 1322 Vikrama era Mantrarājarabasya with Līlāvāli commentary and in 1326 commentary on Bhuvana-dīpaka (a work on the method of answering questions astrologically) of Padmaprabha and Gaṇitatilakavṛtti.

PRIORITY BETWEEN YOGAŚĀSTRA AND JÑĀNĀRṆAVA

Pt. Nāthuram Premi in his work 'Jain Sāhitya Aura Itihāsa' refers to the colophon contained in the manuscript (No. 13) of Jñānārṇava of the Bhaṇḍāra at Pātan called Khetarvasi which is dated 1284 Vikrama era and was written for Digambara Sahasrakīrti. It mentions the fact that a manuscript was got written for and given to Yogi Subhacandra by Jāhiṇī. This is certainly the reference to the original manuscript from which the one for Sahasrakīrti was written. Pt. Premiji thinks it curious that there is no mention of the fact that the work was composed by Subhacandra himself and is therefore inclined to believe that the author of Jñānārṇava must be some prior Subhacandra probably a grand-preceptor of the Subhacandra referred to in the colophon as in those times the name of an Āchārya was many times given to his grand-pupil. Pt. Premiji infers from this that there must be an interval of about 25 to 30 years between Sahasrakīrti's manuscript and Subhacandra's manuscript and an interval of about 30 to 40 years between Subhacandra and his supposed grand-preceptor Subhacandra who wrote Jñānārṇava. Pt. Premiji would thus fix the date of Jñānārṇava to be about 1214 Vikrama era although through an apparent mistake of calculation (as ascertained from him by the writer) he mentions it to be the last quarter of the 12th century of Vikrama era.

The weak link in Pt. Premiji's argument, it would be apparent to the reader, is the supposition of another prior Subhacandra as the author of Jñānārṇava. Pt. Premiji himself admits (p. 447) that the various qualifications* of Subhacandra mentioned in the colophon in all respects apply to the author of Jñānārṇava. The truth therefore is that it really describes the author and the manu-

‘तया कर्मक्षयस्यार्थं ध्यानाध्ययनशालिने ।
 तपःश्रुतनिधानाय तत्त्वज्ञाय महात्मने ॥
 रागादिरिपुमल्लाय शुभचन्द्राय योगिने ।
 लिखाप्य पुस्तकं दत्तमिदं ज्ञानाणवाभिधम् ॥’

script was the first copy or Prathamādarśa of the author and the supposition of a prior Subhacandra as the author is quite redundant as there is nothing to support it except a mere doubt arising from an omission which may be accidental. Further, we do not think that the mention of Subhacandra himself being the author in the colophon recording Jāhṇī's gift of the manuscript which is stated to have been got written for him is so material as to warrant the kind of inference drawn by Pt. Premiji. The proper date of Jñānārṇava would therefore be circa 1254 Vikrama era. Hemacandrācārya the author of Yogaśāstra having died in 1229 Vikrama era it would be clear that Yogaśāstra was written earlier than Jñānārṇava. Its probable date is about 1216 * as it is referred to in Triṣaṣṭhisalākāpuruṣacaritra written between 1216 and 1229 Vikrama era. Before going further into this question, we would tell the readers that this question is being discussed because in Yogaśāstra there are several verses which practically agree verbatim with some verses in the first chapter of Anubhavasiddhamantradvātriṃśikā and the same verses appear in Jñānārṇava apparently paraphrased.

All the three works describe Mantras for achieving various worldly objects as also for attaining final beatitude. Compare vv. 1, 4 and 6, I, Anubhavasiddhamantra-dvātriṃśikā with vv. 31, 43 and 44, VIII, Yogaśāstra and vv. 36-37 and 60-61 XXXVIII, Jñānārṇava. Śrī Hemacandrācārya in his own commentary on the said verse 31 says that contemplation on 'Om' as of yellow and other colours is described as it may be sometimes useful. Śrī Subhacandrācārya in v. 4, XL, Jñānā. says that the best of sages have published many 'Karmas' from Vidyānuvāda (i. e. X Pūrva) to satisfy the curiosity of people though they are achieved only through malignant Dhyāna. Mantras and Vidyās for achieving laudable objects are considered to be part of

* Both Dr. Buhler and Rasiklal C. Parikh the learned author of the Introduction to Kāvyaṇuśāsana consider the date of Yogaśāstra to be shortly after 1216 Vikrama era and that of the commentary on it a few years later.

Dharma-Dhyāna especially Saṁsthānavicaya just as Piṇdashtha, Rūpastha and Rūpātīta Dhyānas are a part of the said division of Dharma-Dhyāna. Mantras and Vidyās for achieving evil objects are part of Ārta or Raudra i. e. Malignant Dhyāna. To them, who would not distinguish between Mantras and Vidyās for achieving good and bad objects and condemn all Mantras and Vidyās absolutely calling them Pāpaśruta, this will be an eye-opener. It is needless to add that both Śrī Hemacandrācārya and Śrī Subhacandrācārya must have been great believers in Mantras and Vidyās, when they introduced this novel mode of describing Dhyānas + as Piṇdashtha, Padastha, Rūpastha and Rūpātīta and described them as a part of Dharma-Dhyāna, and set forth the ancient holy Mantras while treating Padastha Dhyāna.

In the said verses the readers would find that Yoga. closely follows Anubhava., while Jñānā. paraphrases and expands the same idea. Even 'Vidyāratna' occurring in v. 1, I, Anubhava. is echoed as 'Tattvaratnāni', in v. 81, VIII, Yoga. and as 'Tattvāni Ratnāni' in v. 115, XXXVIII Jñānā. Comparing vv. 8 and 15, I, Anubhava. with vv. 74 and 81, VIII, Yoga, and vv. 106 and 115, XXXVIII, Jñānā., we find that Anubhava. and Yoga. agree that the Mantra or Yantra described therein had been extracted from Vidyāpravāda Pūrva mainly by Śrī Vajraswāmi *, while Jñānā. in the said verse 106 says that it was by sages Sañjayanta and others. The former two works represent the Svetāmbara tradition in as much as both of them ascribe the extraction of Mantra or Yantra from Vidyānupravāda to Śrī Vajraswāmi, so well known as the last 'Daśapūrvadhara' amongst Svetāmbara Jains, while Jñānā., following probably the Digambara tradition ascribes it to Sañjayanta and others. The next verse 75,

+ See the writer's article in Gujarāti entitled 'Yogiśvāra Śrī Hemacandrācārya and Dhyānanirūpaṇa' in the monthly named 'Suvāsa' Vol. I, 12 & Vol. II, 2.

* The correct reading in v. 8, I, Anubhava. as appears from a copy made by the writer from another manuscript is 'श्री वैरस्वामिसूरिभिः' instead of 'श्री वीरस्वामिसूरिभिः' Vairaswāmi being the Prakṛta rendering of Vajraswāmi.

VIII, Yoga. appears to be reflected in the verse 107, XXXVIII Jñānā., while the former is word for word the same as v. 15, I, Anubhava. except for the difference of reading viz. 'Janma' instead of 'Karma' in the latter. We may also note that 'Prasāntimeva' in Anubhava. is a misprint for 'Prasāntinava'. The sequence also of vv. 74 and 75 Yoga. appears to have been followed in vv. 106 and 107 in Jñānā. The readers would note the close agreement between Anubhava. and Yoga. and that Jñānā. paraphrases while borrowing and that many a time as here the paraphrase by Jñānā. is far from happy—it is rather clumsy in this case. From the close agreement between Anubhava. and Yoga. we infer that Yoga. borrows from Anubhava., and from the fact that the sequence of Yoga. is retained in Jñānā. we infer that the latter borrows from Yoga. The fact that Jñānā. paraphrases shows the anxiety of the later writer to conceal the fact of his borrowing from the former work. Further Yoga. has vv. 64 and 65 in ch. VIII which are word for word the same as verses 13 and 14 in ch. I Anubhava., but there are no verses in any way similar to them in Jñānā which conclusively proves that Yoga. had Anubhava. before it and borrowed from it and not from Jñānā. Further Jñānā. has no verses which are not in Yoga. but are in Anubhava., so Jñānā. had not Anubhava. probably before it. Now if one has the audacity despite these facts to suggest that granting Jñānā. had not Anubhava. before it the same sequence of verses in Yoga. as well as Jñānā. may as well be due to Yoga. borrowing from Jñānā. as the latter from the former. To him our reply is that the said verses, being admittedly similar to the verses in the earlier work Anubhava., are not the original composition of Jñānā. It must therefore be first shown from what independent source (such as would not be available to Yoga.), they have been taken by Jñānā before it can be suggested that they are taken by Yoga. from Jñānā. On the contrary as the said verses in Yoga. closely agree with those in Anubhava. it is certain that Yoga. took them from Anubhava. and that therefore Jñānā., having had no other source to borrow from, borrowed them from Yoga., and while doing so paraphrased them. The clumsiness of Jñānā. in paraphra-

sing and expanding is clear from its said verse 107, where it recommends the scripture propounding 'Siddhacakra' for contemplation, forgetting that in the preceding verse what has been recommended for contemplation is 'Siddhacakra' it self. The reason given therein that because of its preaching in regard to 'Siddhacakra' the scripture should be contemplated instead of 'Siddhacakra' shows how far-fetched it is from the main theme. Yoga. as well as Anubhava. speak of 'Siddhacakra' alone for contemplation and have nothing to say about the scripture propounding 'Siddhacakra'. We are not basing our conclusion on isolated verses in these works. There is a complete agreement between verses 9 to 14, I, Anubhava. with verses 60 to 65, VIII, Yoga., except that instead of 'अर्हकारं' in v. 11 Anubhava. there is 'अहम्लीकारं' in v. 62 Yoga., which leads us to believe that the latter has borrowed from the earlier Anubhava. The said verse 9, I, Anubhava. and the said verse 60, VIII, Yoga. appear to have been expanded into verses 86 and 87, ch. XXXVIII by Jñānā. by resorting to figurative language and by addition of redundant phrases. It would be clear to any discerning man that this is an instance of expansion by a later writer and not an abridgement in a later work of an idea expressed in details in a previous work. The next verse 88, XXXVIII, Jñānā. though shown to be a part of the original text in the printed edition of Jñānā., is really a quotation as shown by Pt. Nāthuram Premi in his work 'Jaina Sāhitya—Ara Itihāsa' (pp. 450–51) by a reference to the two old manuscripts of Jñānā. The said verse 88 expresses in a different meter and in other words the same idea as is contained in v. 10, I, Anubhava. and v. 61, VIII, Yoga., both the latter verses being word for word the same and in Anuṣṭubh meter except for the difference in reading viz. 'वृणाम्' in Yoga. instead of 'सदा' in Anubhava. In this case the verse in Jñānā., being admittedly not an original verse and having not been taken from any other known source, must be taken definitely to have been borrowed from Yoga. As there are innumerable verses in Jñānā. which are similar to verses in Yoga. and are not similar to any verses in Anubhava. the inevitable conclusion

is that Jñānā. has borrowed from Yoga. The reader would like to know why is the verse which is admitted to be a quotation happens to have been paraphrased in Jñānā. The answer is that the author of Jñānā. appears to prefer Āryā meter to Anuṣṭubh and has therefore to paraphrase while converting it to that meter or that being anxious to conceal his borrowing from Yoga., he paraphrases even the quotation. We have, made our remarks relating to v. 11, I, Anubhava. and the corresponding verses in the other two works. The next v. 12 I, Anubhava. is word for word the same as v. 63, VIII, Yoga. The verse 91, XXXVIII, Jñānā. is on the face of it a paraphrase of the said verse. The reader would note how happy is the adjective 'Anavadyām' in Anubhava. and Yoga. and compare the corresponding 'Acintyavikramām' of Jñānā. and further note how Jñānā. again uses the same adjective 'Acintya' in the same verse. If it had been the poet's original composition he would not have been driven to use the same adjective twice in one and the same verse. Further what the other two works describe as the Vidyā emanated from Gaṇadharas is described as emanated from Lord Vīra by Jñānā. The tradition however is that Lord Vīra communicated 'Tripadī' to the Gaṇadharas and the latter composed all the scriptures. Of course, Pūrvas, we consider to be ancient and in that way the Vidyās contained in one of the Pūrvas can be said to have emanated from Lord Vīra or rather from the first Tīrthaṅkara as far as the present cycle of time is concerned. This verse proves the antiquity of Sūrividyā which is the same as Gaṇabhṛd Vidyā or Sūrimantra. The next verses 13 and 14, I Anubhava. which are word for word the same as vv. 64 and 65, VIII, Yoga. have been already dealt with by us.

We referred to v. 88, XXXIII, Jñānā. above which is really a quotation in the said work and is a paraphrase of v. 61, VIII, Yoga. and stated that it must have been therefore borrowed definitely from Yoga. Other instances are v. 3 Jñānā. p. 392 and v. 2, Jñānā. p. 407 which are shown as quotations therein and are respectively a

paraphrase of vv. 24 and 79, VIII, Yoga. Further there are quotations in the author's own commentary on v. 5 and vv. 18-22, VIII, Yoga. which are also quotations in Jñānā. v. 2 (quoted), XXXVIII, p. 388 and v. 1 (quoted), p. 391 Jñānā. A later writer abridging a former work would not relegate to his commentary the verses quoted by the former writer in the text, for the simple reason that even the previous writer considers them sufficiently important to quote them in the body of the text. Here Jñānā. considering the verses quoted in the commentary on Yoga. sufficiently important quotes the same in the body of the text. This is also a proof as to Jñānā. borrowing from Yoga. as well as its commentary. It may be noted that the verses quoted either in the text or the commentary, ch. VIII, Yoga. are more or less faithfully reproduced in Jñānā., while the verses which form part of the text of Yoga. even if quoted in Jñānā. are not reproduced there in the same words. Strangely enough there are some verses forming part of the text of both the said two works which are word for word the same except sometimes a slight difference in readings—see v. 37 and 69. VIII, Yoga. and vv. 46 and 100, XXXVIII, Jñānā.; cf. also v. 5, X, Yoga. with v. 4 XXXIII, Jñānā. We shall also note v. 79, VIII, Yoga. and v. 2 (quoted) p. 407, Jñānā. as they are quotations in both the works and agree with a slight difference in reading viz. 'अन्येग्रन्थविस्तराः' in Yoga. and 'अन्यद्ग्रन्थविस्तरः' in Jñānā. The verse 22, XXXVIII, Jñānā. is very important as it refers to another author or Āchārya, who makes variations of letters in the Dhyāna of Mantrarāja or Mantrādhipa viz. 'Arham'. Comparing ch. VIII, Yoga. with ch. XXXVIII, Jñānā. we find almost all the verses of Yoga. assimilated in Jñānā. but vv. 6 to 17 remain untouched. We think Jñānā. refers to this portion of Yoga. and its author Hemacandrācārya in the said v. 22. At several places Jñānā. has added merely laudatory verses in the said ch. XXXVIII while expanding the matter taken from ch. VIII, Yoga. Jñānā. amplifies by expanding a single verse of Yoga. into two or more verses and adding Purāṇic illustrations and resorting to figurative language and sometimes to

indirect or abstruse mode of expression and adding unnecessary adjectives, descriptions or eulogies. If the reader would read ch. XXXVIII, of Jñānā. for himself he would be convinced of the truth of our aforesaid remarks. We would not therefore exhaust our reader's patience by taking him through the said chapters verse by verse. As we have minutely compared all the verses in the said chapters, we feel certain that the reader also would on an independent examination of the said chapters come to the same conclusion. The reader would find also in some of the verses not noticed here clear evidence of Jñānā. having borrowed and paraphrased verses from Yoga.

We shall now consider what other scholars have said on the question of the respective dates of the authors of the said two works. Pt. Nāthuram Premi has, while discussing in his work 'Jain Sāhitya Aura Itihāsa', the date of Śubhacandrācārya and his work Jñānārṇava, stated that he first discussed it in 1907 A. D. in his Introduction to Jñānārṇava believing Bhattāraka Viśvabhūṣaṇa's Bhaktāmaracaritra to be authoritative; but that in the special issue of 'Digambara-Jaina' (Śrāvaṇa 1973 S.Y. i. e. 1917 A. D.) in the article entitled 'Śubhacandrācārya', he controverted his own arguments in the said Introduction as the historicity of the greater portion of the narrative literature written by later Bhattāarakas appeared doubtful to him. The said Bhaktāmaracaritra has absurdly described Bhoja, Kālidāsa, Vararuchi, Dhanañjaya, Mānatuṅga, 'Bhartṛhari, Māgha and several others to be contemporaries, although every historian knows that they were not so. It also describes Śubhacandrācārya to be a brother of the famous Bhartṛhari as also of King Bhoja. How can anyone be a brother to persons who lived centuries apart? Pt. N thuram Premi rightly complains that the publishers of Jñānārṇava, though duly informed of his having revised his opinion expressed in the said Introduction and his having controverted the same in the said article entitled 'Śubhacandrācārya' published in 'Digambara-Jaina', have published two further editions of Jñānārṇava with the same old Intro-

duction. They could have at least appended a note about Pt. Premiji's latest and considered views.

EXAMINATION OF MR. PATEL'S VIEWS

We are surprised however, to see the same unhistorical Bhaktāmaracaritra being relied on in fixing the date of Subhacandrācārya by Mr. Gopaldas Jivabhai Patel in his Introduction to 'Yogaśāstra', which purports to be a free rendering by him in Gujarāti of the original Yogaśāstra. Relying on the said work he takes Subhacandrācārya to be a brother of the famous King Bhoja whose date he takes to be 1078 Vikrama era. He ascribes the same date to Subhacandrācārya and consequently considers him to be about 70 or 80 years older than Hemacandrācārya. Starting with such incorrect assumption Mr. Patel compares their respective works. Although he notes that Yogaśāstra is a concise and systematic work and that Jñānārṇava is a work written in the loose style of a religious discourse, he credulously says that there is greater reason to suppose that Yogaśāstra was composed by systematizing and abridging Jñānārṇava. We are inclined to think that if Mr. Patel had minutely compared both the works or if he had realised the unhistorical nature of Bhaktāmaracaritra he would have probably come to a different conclusion. He himself has felt doubts about his own conclusions and he has expressed the same in his Introduction. He also says that Hemacandrācārya, having been surrounded by many enemies, always ready to denounce him, could not have dared to commit such plagiarism. He has however not been able to free himself from the tangle of Bhaktāmaracaritra, and has landed himself in an inextricable hole, when he hazards the conjecture of a very large portion of Yogaśāstra, viz. chs. V to XI being interpolation by some unknown and unnamed overzealous pupil of Hemacandrācārya with the object of enhancing the glory of his great Guru. He does not assign any reason for his conjecture except that Hemacandrācārya himself could not have been guilty of devoting disproportionately a large portion of his work to the

description of Prāṇāyāma. He suggests that the object of such a pupil might have been to give to his preceptor the credit of describing miraculous matters from such a popular work as Jñānārṇava. There is no evidence whatsoever of Jñānārṇava having become popular immediately or even during the supposed interval of 70 or 80 years between Subhacandrācārya and Hemacandrācārya. It is also not shown that Jñānārṇava was the only work containing description of miraculous matters. Our readers know that not only Anubhavasiddhamantradvātriṃśikā but also Vidyānuśāsana and various works of the famous Māntrikas Indra-nandi and Malliṣeṇasūri in fact dealt with such matters. They were all prior to the date of Śrī Hemacandrācārya. As regards the supposed disproportionateness of the portion relating to Prāṇāyāma in Yogaśāstra, as Mr. Patel himself has noted at p. 37 of his said Introduction, the said portion contains various methods of knowing beforehand the exact date or hour of one's death. He mentions only astrology and omens. As a matter of fact besides Prāṇāyāma and the said two methods of divination the author has described other methods of divination such as divination through one's breath, dreams, or gazing on one's shadow, or by listening to words of different classes of people, or through employment of Vidyās or Mantras or Yantras. He further describes in the same ch. V the method of entering the body of any other creature. Mr. Patel is not right when he says Hemacandrācārya has devoted 300 verses to the description of Prāṇāyāma. In fact he has devoted only 35 verses to that topic. The remaining portion of ch. V is taken up in the description of the said various methods of divination and the Yogic miracle of entering the body of another creature. To Mr. Patel these methods of divination may be uninteresting, but to judge the author with such a bias is not to judge him truly. The proper standard of examination can be had only if one takes into account the times in which and the people for whom the work was written. The fact that every one of the subjects treated in the said ch. V has independent treatises written on it from ancient times shows rather the popularity of the subjects treated in Yogaśāstra and the comprehensive nature

of the said work, which should add to its merit rather than detract from it in any way. Again it would hardly be correct to say even today, that the methods of divination have lost their charm, when we actually see representatives of all classes of people running after the palmists, astrologers, spiritualists and various other fortune-tellers and diviners and when the list of their patrons include the elite of the society. When thus the main plank of disproportionateness in the theory of interpolation has slipped the whole structure of the supposed interpolation falls to the ground. Further the simplest test to find out whether a particular portion of a work is interpolated or not is to remove the suspected portion from the work and see whether the remaining work has completeness and whether the unity of theme remains intact. Had the said test been applied, it would have been immediately found out that out of the eight well-known parts of Yoga only Yama, Niyama and Āsana remain, while the remaining five are taken off, as they are treated in chs. V to XI of Yogaśāstra. Nobody would ever imagine that the great author of Yogaśāstra while writing on Yoga dealt only with the three preliminary parts and said nothing regarding the remaining five important parts of Yoga. This conclusively proves that Mr. Patel's theory of interpolation in Yogaśāstra by some overzealous pupil is really a myth.

Besides the allegation of want of proportion Mr. Patel speaks about repetition in Yogaśāstra because the author of Yogaśāstra describes Dhāraṇā in v. 7, ch. VI, having described Dhāraṇā of breath in ch. V, vv. 27 to 35. The simple answer is that in ch. V he deals with Dhāraṇā as a part of Prāṇāyāma, where control of breath is the principal element and the object to be achieved is the fixing of the mind. In v. 7 ch. VI he merely mentions various parts of the body for the exercise of Dhāraṇā, which are not mentioned in ch. V. In Dhāraṇā mentioned in ch. VI, the fixing of the mind is the principal element and the control of breath is secondary, and the object to be achieved is Dhyāna, the details of which are described

in the subsequent chapters. The readers would thus see that there is no truth in the said charge of repetition. One is really amused to see that while Mr. Patel is hypercritical about the supposed want of proportion and repetition in Yogaśāstra, he is quite oblivious of the frequent repetitions, panegyrics and laudatory verses occurring at various places in Jñānārṇava. We are however sure that Mr. Patel's attention was not drawn to Anubhavasiddhamantradvātriṃśikā published in 1937 A. D. as Appendix 30 to Śrī Bhairava Padmāvatī Kalpa, a year prior to his 'Yogaśāstra', otherwise he would not have failed to take it into account while considering the question of priority between Yogaśāstra and Jñānārṇava.

We should like to note here a fact which has not been considered in the discussion about the priority between the two works. As a result of the historic debate, already mentioned at p. 216 ante, between Svetāmbara Vādi Devasūri and Digambara Kumudacandra, which took place in the court of Siddharāja in 1181 Vikrama era, the Digambara Jains had to leave the country ruled over by King Siddharāja. The new works composed by Digambara Jains were not therefore available to Svetambara Jains. On the other hand, whatever Śrī Hemacandrācārya wrote was widely circulated by his Royal patrons. There is therefore a greater probability of Yogaśāstra having come to the hands of Śrī Subhacandrācārya and having been largely drawn upon by him for writing Jñānārṇava rather than Jñānārṇava coming to the hands of Śrī Hemacandrācārya.

APPENDIX 31

This appendix contains the famous hymn 'Laghuśānti' of Śrī Mānadevasūri pupil of Pradyotanasūri. He was born of Jinadatta and Dhāraṇī at Nādol. We have already described his life (see pp. 196-7 ante). We have also stated that the epidemic at Taxilā was the occasion for the composition of this hymn (see p. 197 ante). He was a great Māntrika and was constantly attended upon by the deities Jayā and Vijayā (according to Gurvāvali also by Padmā and Aparājītā). In the

hymn he has praised Jayā, Vijayā, Ajitā and Aparājitā. He is also the author of the famous hymn Namiūṇa which comprises the famous Cintāmaṇi Pārśvanātha Mantra. There is an Avacūri and another commentary on Laghuśānti, the latter by Upādhyāya Śrī Guṇavijaya (s. y. 1659); the one given here is by Śrī Dharmapramodagaṇi. The Mantra mentioned in v. 14 is Mantrādhirāja relating to Śrī Pārśvanātha. The entire Mantra of Śrī Śāntinātha as given in the commentary on v. 15 may be compared with Śāntibalimantra given in Nirvāṇakalikā pp. 25–26, as also with Śāntidevī's two Mantras, especially the 2nd Mantra, at pp. 6–7 Ācāradinakara Vol I. A special sanctity attaches to this hymn as it forms part of both the morning and evening Pratikramaṇa (Confession and Repentance) ceremonies.

We have to note that it was at Taxilā that Śrī Bāhubali, son of the first Lord Ṛṣabhadeva, got Dharmacakra installed, when he could not see the Lord when he went to make obeisance to Him in the morning. According to Mahānisītha Dharmacakra at Taxilā related to Śrī Candraprabha, the eighth Lord. When Huen-tsang came to India in the 6th century of Vikrama era, it was in the possession of the Buddhists who believed it to be of Candraprabha Bodhisattva. The fact—that only a few years back remains of Jain temples were discovered at Taxilā while excavations were being carried on there under the supervision of the archaeological department—bears out the tradition recorded in Prabhāvakaacaritra that even till the time of its author brass and stone images were supposed to exist in the underground cellars at Taxilā.

Parsis and Mantras

AS some of the writer's Parsi friends have desired that we should also deal with Parsi's belief in Mantras, we would very briefly do so as limitations on space at our disposal would not permit us to treat of the same in details. "Zarathushtra recognized the worship of only one Supreme Being, the Great Lord alone, the one without a second. He also declared the six Attributes of the Lord to be worthy of our adoration, and in places spoke of Them as Divinities, the Holy Immortals. × × × Ātar (Fire), being the living symbol of Zarathushtra's Faith, was also given a place in the Gāthās. Besides the six Holy Immortals and Ātar, there are two other Beings mentioned in Gāthās—Sraosha and Ashi—who are also to be taken in much the same way as the Amesha-Spentas." P. 91, 'The Religion of Zarathushtra' by Dr. I. J. S. Taraporewala. *

THE AMESH-SPENTAS OR HOLY IMMORTALS

The Amesh-Spentas are six; sometimes Ahura Himself is mentioned together with them and then they are spoken of as the *seven* Holy Immortals. We describe them below particularly.

1. Asha-Vahishta (the highest or the best Asha). Very early He represented fire, the symbol of the Zoroastrian Religion. In the Pahlavi language His name is Ardibesht. He is the Lord of Fire. Originally Asha-Vahishta meant the highest Truth or Righteousness or the Spiritual or Divine Law or the Law of God.

2. Vohu-Manō is later Bahman. In later times Bahman occupies the first place among the Holy Immortals, while Ardibesht takes second. Literally Vohu-Manō means Good Mind implying loving kindness and good will towards all beings, including the animal creation. "Quite logically, therefore, many Parsis have held that early

* The writer acknowledges his great indebtedness to the said valuable work of Dr. Taraporewala in writing the present section.

Zoroastrians must have abstained from meat-eating." (P. 86).^x It is Vohu-Manō who leads mankind upto Asha. Emphasis laid on purity of mind-Cittaśuddhi by the various systems of Indian Philosophy may be advantageously compared. Amṛtabindu Upaniṣad also speaks of two kinds of Mind pure and impure.⁺

3. Kshathra-Vairya means the Supreme Power, the Perfect Strength, or the Omnipotence and the Universal Sovereignty of the Lord. Divine Power is attained by one who treads the path of Truth or obeys the Law of God. Kshathra-Vairya later becomes Shahrivar the Lord of Mineral Kingdom.

4. Spenta-Ārmaiti or Holy Devotion stands at the head of the feminine group of the three Holy Immortals as Asha stands at the head of the masculine group of the three Holy Immortals. She has been also identified with Mother Earth. She is the Spirit of Earth and also Divine Wisdom and Grace. She is the Guardian of the Faith of Zarathushtra. In Gujarati she is called 'Spendārmad'.

5 & 6. The twin Amesh-Spentas, Haurvatāt and Ameretatāt stand for 'Wholeness' and 'Immortality'. Haurvatāt is Spiritual Perfection. Haurvatāt and Ameretatāt are the Guardians of the waters and of the vegetable Kingdom respectively. In Gujarati they are called 'Khordād' and 'Amerdād' respectively.

YAZATAS

Yazatas (the Adorable Ones) are Divine beings who may be called the Angels to distinguish them from Amesh-Spentas who may be called the Archangels. They correspond to the 'Devas' of Hindus. In later Zoroastrianism, the three most important Yazatas are Ātar Ashi and Sraosh. The number of Yazatas including Amesh-Spentas

^x "There are clear indications in the Gāthās about the sin of killing animals." P. 90, 'The Religion of Zarathushtra'

⁺ ॐ मनो हि द्विविधं प्रोक्तं शुद्धं वाशुद्धमेव च ।
अशुद्धं कामसंकल्पं शुद्धं कामविवर्जितम् ॥१॥

usually given is thirty-three like that of the Vedic gods. The Yazatas are regarded as Powers subordinate to Ahura Mazda, the Supreme God, and as the servants of His Will. While some of them are only personifications of Divine Attributes, others represent the Elements i. e. the Powers of Nature or the original Indo-Irānian Deities.

Among these Sraosh stands for obedience to the Divine Law and is the Guardian Angel of Humanity, for Obedience to the Law of Mazda is the highest protection humanity could have. He guards night and day all the creatures of Mazda holding uplifted His double weapon. The most efficacious of His weapons are the Holy Chants (Manthras), His body is the Holy Chants (Tānumānthra). He is the special Guardian of the Zoroastrian flock. His aid is invoked at night when the powers of evil stalk abroad, and the cock, who ushers in the day is the bird sacred to Sraosha. He is very closely associated with the human soul after death. Rashnu and Mithra are the two Divinities closely associated in later Avesta with Sraosh in the task of judging the souls of the departed. Ashi Vanguhi (Holy Blessings) has been constantly associated with Sraosh. In later ages the blessings were understood more in the material sense of riches and Ashi became a sort of Goddess of Fortune actually translated as Lakshmī in the Sanskrit version of the Avesta texts by Nairyosang (circa 1200 A. D.). Her aid has been invoked by the great prophets and Heroes of Irān. She is also the guardian of Matrimony.

Among the Powers of Nature invoked in the Avesta are the Fire or Ātar, the waters or Aradvisūra, Anāhita, the Wind or Rāman (the ancient Vāyu) and the Earth or Zam. Anāhita is mentioned as the patron of the King of Kings side by side with Ahura Mazda and Mithra (or Mitra—the sun). The image of Anāhita was worshipped in Persia as recorded by Greek writers. In the Yasht (hymn of praise) dedicated to Rāman, the list of His suppliants is headed by Ahura Himself. Hvarekshaētra—later Khurshid—the Sun, Māongha—the moon, Ushahina (or Ushah or the Dawn), Tishtrya or the Dog—star are

some of the older Indo Iranian Deities, whose worship was revived in post-zoroastrian ages. Asha Vahishta then became the Archangel of Fire. Nairyosangha is the Messenger of the Supreme Ahura mazda to mankind. Ātar-Verethraghna becomes in later language Ātash Behrām meaning the most sacred Zoroastrian Fire Temple.

CULT OF MITHRA

In later Achaemenian days the cult of Mithra developed into a definite school of religious thought in Irān and grew into an important esoteric school of occultism. Certain mystic rites and ceremonies were early associated with this cult. The cult spread throughout the Greek and later the Roman world and all over Europe. Even in far off England shrines of Mithra have been found. The worship of the ancient Āryan Sun-God was a very dominant cult in the early days of Christianity and influenced the new religion as well. Airyaman is the Deity associated with Mithra and Varuṇa in the Veda where he is invoked during marriage ceremony and a short hymn dedicated to him is still used among the Parsis today as an essential part of the marriage ceremony.

Another Āryan Deity whose worship was revived in the later Avesta days was Verethraghnā (Vedic, Vṛitrahan), the slayer of the Arch-Fiend Vṛitra. He is the Angel of Victory. Later He is called Behrām.

FRAVASHIS

Parsis thus worship besides the Supreme Being several Deities and offer hymns of praise to them (Yashts). They also invoke the Fravashis of the departed, for the Fravashis of the good are regarded as the guardians of creation. The Fravashi is the highest and the eternal principle in all beings. The Yazatas and the Amesha-Spentas and even Ahura Mazda have their Fravashis. They are said to be archetypal souls clothed in ethereal forms. This worship has its parallel in the Hindu worship of Pitṛis and the Roman worship of the Manes.

PRINCIPAL DOCTRINES

Of the several methods to reach God treading the path of Asha (Spiritual life) such as knowledge, Devotion and Action the method most emphasized in Zoroastrianism is that of Action, although there are hints about all these three scattered in Avesta. "Zoroastrianism is above all a *Religion of Action*—Karma Yoga, to use the Hindu phrase. xxx The whole Teaching has been compressed into three commandments—Humata, Hūkhta, Huaarshta (Good Thoughts, Good Words, Good Deeds). And though, as necessarily, thoughts come first, as the roots of all action, still *Good Deeds* constitute the chief qualification in treading the Path of Ash. xxx Never has seclusion from the world and from worldly duties formed part of the Zoroastrian belief". The Law of Karma or the Law of Action and Reaction has been clearly recognized in Zoroastrian theology but nowhere is there a reference to condemnation or reward through all eternity. As for the doctrine of Reincarnation which is a necessary corollary to the Law of Karma Parsi scholars say that it may be deduced by a sort of implication, but is not expressly put forward in *Gāthās*. The popular belief of Parsis however is that there is life after death.

VEDIC CONNECTION

'Athraavan' is the term used in Avesta for the Priest which is phonetically connected with Atharvaveda. It indicates that the cult of Fire had been definitely established in Irān. We have shown (see footnote* 228 ante) that Atharvans and Aṅgiras of the Atharvaveda respectively signified the white or holy and the black or hostile magic. Perhaps it may furnish a clue to the use of the term 'Angrō—Mainyu' for the Power of Evil which Zarathushtra conquered. Historically it may have reference to the struggle between the two factions of Āryans, one of which was helped and guided by Ṛṣis of the Aṅgiras Kula, and the other by those of Ātharvan Kula. According to Mr. Mānshanker P. Mehta, the learned author of the Gujarati book entitled 'Ahunavara' (published by Śrī Forbes Gujarati Sabhā), it

appears from the R̥gveda that the fire cult was started in ancient times by the R̥ṣis of Bhṛgu, Ātharvan and Aṅgiras Kulas; that Bhṛgus were against the worship of Indra introduced by Aṅgiras; that Bhṛgus and Ātharvans, the spiritual guides of the faction of Āryans which left India and ultimately went to Irān, stuck to the ancient fire cult and Soma-cult; and that Zarathustra although a reformer retained fire-worship and the worship of Soma of the Vedic Gods like Agni, Sūrya, Mitra, Aryamā, Varuṇa (Asura Varuṇa) and others as subordinate to the Supreme Being called Ahura Mazda. The 'Devas' of the Veda were however degraded to the position of the Demons and Asura Varuṇa became the Supreme Being—Ahura Mazda, while the other leading Vedic deity Indra was reduced to the position of the chief lieutenant of the Evil One.

MANTRAS

The 61st chapter (Hā) of Yasna refers to the miraculous powers of the three small prayers viz. Ahuna-Vairya, Ashem Vohu and Yenghe Hātām; they are used by the Parsis even this day. It says that they are very effective in overcoming magicians, evil spirits, thieves, robbers, atheists, the wicked and the liars. The most ancient and according to many pre-Zoroastrian in date is the prayer known as *Ahuna-Vairya*. It is said that "if this prayer is repeated properly even once in the correct rhythm and intonation, and with a clear understanding of its meaning, it is equal in efficacy to the repetition of a hundred other hymns put together. Zarathushtra Himself is said to have chanted this prayer in order to defeat the Evil Spirit when he came to tempt Him. And again and again the Avesta states that "the Ahuna-Vairya protects the Self (tanu)"—P. 68. 'The Religion of Zarathushtra'. It embodies within itself the essentials of Zoroaster's Teaching, and that is the reason according to Dr. Taraporewala why such special efficacy is attached to it. The curious reader would do well to pursue the said very instructive work of Dr. Taraporewala (specially p. 68 et seq.) as it treats of the inner meaning of the hymn

with great lucidity. We would be content to quote from the said work only its translation and the translation of the other two sacred prayers viz. 'Ashem Vohu' and 'Yenghe Hātām' to which miraculous powers are said to be attached.

AHUNA VAIRYA

"Just as a Ruler (is) all powerful (among men), so (too, is) the Spiritual-Teacher, even by reason of His Asha; the gifts of Good Mind (are) for (those) working for the Lord of Life; and the strength of Ahura (is granted) unto (him) who to (his) poor (brothers) giveth help."

ASHEM VOHU

"Asha is the highest good, (it alone) is (true) happiness.

Happiness is for him (alone) who (is) righteous for (the sake of) the highest Asha."

In point of sanctity it ranks second only to the Ahuna Vairya.

YENGHE HĀTĀM

(That man) among those that are about whom, because of his Righteousness.

Mazda Ahura knoweth (that he is) verily better as regards acts of worship (than others)-(All such), both men and women, do we revere.

Regarding 'Ahuna-Vairya' it is laid down that if one does not know one or the other of the Yashts (Hymns of Praise) he may recite 'Ahuna-Vairya' a certain number of times instead of the said Yashts and he would have the merit of having recited the said Yashts. Similarly 'Ahuna-Vairya' is directed to be recited for achieving various objects and also as thanksgiving for benefits received.

It would be clear that although Ahuna-Vairya is a prayer, it is believed to be a Mantra just as Hindus believe Gāyatri or Jains believe Panca Parameṣṭi Mantra to be a Mantra. The same remarks apply to the other two prayers. Both 'Ahuna-Vairya' and 'Ashem-Vohu' are used as part of Kusti-Prayers by Parsis.

It is customary amongst Parsis to recite the hundred and one names of Ahura Mazda as Muhammedans recite the 99 names (Asmā-ul-'husna) of Allāh, or as Hindus and Jains recite Satānāma or Sahasranāma of the Divinity worshipped by them. Parsis generally use rosaries made of 101 amber-beads. It is not known however that there is anything similar to Tāntric Sādhanā amongst Parsis for acquiring accomplishment or perfection (Siddhi) in any particular Mantra so that the Sādhaḥa thereafter becoming a Siddha or an adept is able infallibly to achieve his desired object with the aid of such a Siddha-Mantra. There are however historical instances of Upāsānā of Yazatas like Aradvīsūra Anāhita and Ashi Vanguhi by the great heroes and kings of ancient Irān for achieving various objects.

CONCLUSION

We are glad to bring this Introduction which has grown beyond the farthest expectation and the widest estimate of the writer and the publisher, to a close. We take this opportunity to offer our apologies to the readers of the work for keeping them waiting for the Introduction beyond all reasonable expectation. The only thing which we would like to mention, not as an excuse for the delay but as a matter of fact, is that the Introduction was undertaken when the work itself was practically ready for publication and that we could only devote our leisure hours to the work although many a time we had to encroach upon the business hours also. The readers can well imagine the difficulties besetting the path of the Press and the Publisher in these times of stress, struggle and strife. The readers would therefore appreciate the more the enterprize of the Publisher in placing this very exhaustive work in their hands in such a manner. We thank the Press and the Publisher for the consideration shown by them and also thank the several friends who have been from the very beginning taking keen interest in the progress of the work and have been selflessly and unstintingly helpful in various ways in the preparation of this work. We would not attempt to describe the kind

of service rendered by each of these esteemed friends. We would however expressly acknowledge the very great help received from the books issued to the writer from time to time by Muni Śrī Mohanlalji Jain Central Library, Madhav Baug, Bombay. ARHAM OM !

15 Dhanji St., Bomby,
27th April 1944,
Vaiśākha Śukla Pancamī
s. y. 2000.

}

MOHANLAL B. JHAVERY

APPENDIX A

। श्री मानदेवसूरिकृतसूरिमंत्रस्तोत्रम् ।

रागाइरिउजईणं, नमो जिणाणं नमो महजिणाणं¹
एवं² ओहिजिणाणं, परमोहीणं तहा तेसिं³ । १ ।
एवमणंतोहीणं, णंताणंतोहि—जुअ⁴—जिणाण
नमो सामन्नकेवलीणं भवामवत्याणं⁵ तेसि नमो । २ ।
उग्गतवचरणचारिणं⁶, मेवामित्तो नमो नमो होउ
चउदससदसपुव्वीणं, नमो तहेगार⁷संगीणं । ३ ।
एएसिं सव्वेसिं, एव किच्चा⁸ अहं नमोक्कारं⁹
जमियं¹⁰ विअं पउंजे, सा मे विआ पसिजिआ । ४ ।
निच्चं¹¹ नमो भगवओ, घाहुबलिस्सेह पण्हसमणस्स¹²
नै वग्गु वग्गु निवग्गु, मग्गुं सुमग्गु गयस्स तहा । ५ ।
सुमणेवि अ सोमणसे, महुमहुरे जिणवरे नमंसाभि
इरिकाली पिरिकाली, सिरिकाली तहा महाकाली । ६ ।
किरिआए हिरिआए, पयसंगए तिविह आयरिए¹³
सुहमव्वाहयं तह, मुत्तिसाहगे¹⁴ साहुणो वंदे । ७ ।
नै किरिकिरि कालि पिरि, पिरिकालिं च सिरिसिरि सकालिं
हिरि हिरि कालि पयंपिअ¹⁵, सिरिं तु तह आयरिय¹⁶कालिं । ८ ।
किरिमेरु पिरिमेरु सिरिमेरु तहय होइ हिरिमेरु
आयरिय मेरुपयभवि साहंते मेरुणो वंदे । ९ ।
इअ मंतपयसमेया, थुणिआ सिरिमाणदेवसूरिहिं
जिणसूरिसाहुणो¹⁷ सइ, दिंतु थुणंताण सिद्धिसुहं । १० ।

1 मणोजिणाणं; महंहोंउ 2 एवं 3 तेसि 4 जुअ 5 भवामवत्याणं 6 चारीण 7 तहेक्कारं
8 काउं 9 नमुक्कारं 10 जमिउं 11 उ निच्चं 12 पणसमणस्स 13 थंवरिए 14 चसाहए
15 पयमिय 16 अ 17 सूरिणो.

। योनिप्राभृतांतर्गतमंत्रौ ।

। श्रीमाणिभद्रमंत्रः ।

ॐ नमो भगवते माणिभद्राय कपिलरूपाय अनंतशक्तिसहिताय नवनागसहस्र-
बलाय अतुलबलवीर्यपराक्रमाय किंनरकिंपुरुषगरुडगंधर्वयक्षराक्षसभूतपिशाचसर्व शाकिनीनां
निग्रहं कुरु २ फट् स्वाहा ॥ सर्वनिग्रहमंत्रः ॥ १ ॥

। श्रीगणधरबलयमंत्रः ।

(नमो जिणाणं नमो ओधि) नमो परमोधि नमो अणंतोधि णमो कुट्टुबुद्धिणं णमो
पादानुसारीणं णमो संभिन्नसोयाणं नमो (सयं) संबुद्धाणं नमो पत्तेयबुद्धाणं नमो(उ)ज्जुमदीनं
नमो विउलमदीनं नमो दसपुव्वीणं नमो चउदसपुव्वीणं नमो अठंगमहानिमित्तकुसलाणं नमो
विज्जाहराणं नमो चारणाणं नमो आगासगामीणं (नमो घोरतवाणं)¹ नमो आसीविसाणं नमो
दिट्ठिविसाणं नमो उग्गतवाणं नमो दित्ततवाणं नमो महातवाणं नमो घोरतवाणं नमो घोर-
गुणबंभचारीणं नमो आमोसहिपत्ताणं नमो खेलोसहिपत्ताणं नमो विप्पोसहिपत्ताणं नमो
सव्वोसहिपत्ताणं नमो मणबलीणं णमो वचबलीणं णमोकायबलीणं नमो रवीरसप्पीणं नमो
सप्पिआसवाणं नमो अमयमहुसप्पीणं नमो सव्वत्रुद्धीणं नमो भयवदो गणधरबलयस्स सव्वे
सव्वं कुणंतु ॥ गणधरबलयमंत्रः ॥ २ ॥

दिरका आणाकाले असज्जदोसे निमित्तसाहणए
गुरुउवसग्गे जाये(अ) वेर(हि)म्मि भणह (इमं) मंतं ॥

1 एतत्पदमधिकं भाति । अग्रे एतदेव पदं यथास्थानं निवेशितं द्रष्टव्यम् ।

॥ अंगविद्यांतर्गतविद्याः ॥

। अंगविद्या ।

नमो अरिहंताणं नमो सिद्धाणं नमो आयरियाणं नमो उवज्झायाणं नमो लोएसव्वसाहूणं ।
नमो जिणाणं नमो ओहिजिणाणं नमो परमोहिजिणाणं नमो सव्वोहिजिणाणं नमो अणंतो-
हिजिणाणं नमो भगवओ अरहओ अव्वओ महापुरिसस्स महावीरवद्धमाणस्स नमो भगवइए
महापुरिसदिण्णाए अंगविज्जाए सहस्सपरिवाराए (स्वाहा) ॥ १ ॥

। भूतिकर्मविद्या ।

णमो अरहंताणं नमो सिद्धाणं नमो आयरियाणं नमो उवज्झायाणं नमो लोए सव्व-
साहूणं । नमो महापुरिसस्स महइ महावीरस्स सव्वणुसव्वदरिसिस्स इमा भूमिकम्मस्स
विज्जा । इंदि आलिंदि आलिमाहिंदे मारुदि स्वाहा । नमो महापुरिसदिण्णाए भगवईए
अंगविज्जाए सहस्सवाकरणाए क्षीरिणीविरण उडुंबरिणीए सह सर्वज्ञाय स्वाहा सर्वज्ञानाधिगमाय
स्वाहा । सर्वकामाय स्वाहा । सर्वकर्मसिद्धयै स्वाहा ॥ २ ॥

(क्षीरवृक्षछायायां अष्टमभक्तिकेन गुणयितव्यं क्षीरेण च पारयितव्यं । सिद्धिरस्तु ।
भूमिकर्मविद्याया उपचारः चतुर्थभक्तेन कृष्णचतुर्दश्यां गृहीतव्या षष्ठेन साधयितव्या ।
अहतवत्येण कुशसत्यरे ।)

। सिद्धविद्या ।

णमो अरहंताणं नमो सिद्धाणं नमो आयरियाणं नमो उवज्झायाणं नमो लोएसव्व-
साहूणं । नमो आमोसहिपत्ताणं नमो विप्पोसहिपत्ताणं नमो सव्वोसहिपत्ताणं नमो संभिन्न-
सोआणं नमो रवीरस्सवाणं नमो महुस्सवाणं । नमो कोट्टु बुद्धिणं नमो पयबुद्धिणं नमो
अरवीणमहाणसाणं नमोरिद्धिपत्ताणं नमो चउदसपुव्वीणं नमो भगवईए महापुरिसदिण्णाए
अंगविज्जाए सिद्धे सिद्धाणुमए सिद्धासेविए सिद्धचारणाणुचिण्णे अमियबले महासारे महाबले
अंगदुवारधरे स्वाहा ॥ ३ ॥

(छट्टुग्हाणी छट्टुसाहणी जपो-अट्टुसयसिद्धा भवति ॥)

। पडिरूवविज्जा ।

नमो अरिहंताणं नमोसिद्धाणं नमो महापुरिसदिण्णाए अंगविज्जाए नमोकारइत्ता
इमं मंगलं पउंजइस्सामि सा मे विज्जा सव्वत्थ पसिज्जउ । अत्थस्स य धम्मस्स य कामस्स
य इसि(स)स्स आइच्च चंदनकरवत्तगहगणतारागणाण (जोगो) जोगाणं नमम्मि अ जं सव्वं
तं सव्वं इह मज्झं (इह) पडिरूवे दिस्सउ । पुढविउदधिसलिलाग्गिमारुएसु य सव्वभूएसु

देवेषु जं सव्वं तं सव्वं इध मज्झ पडिरूवे दिस्सउ । अवेतु (उ) माणुसं सोयं (दिव्वं सोयं) पवत्तउ । अवेउ माणुसं रूवं दिव्वं रूवं पवत्तउ अवेउ माणुसं चक्खुं दिव्वं चक्खू पवत्तउ । अवेउ माणुसे गंधे दिव्वे गंधे पवत्तउ । एणसु जं सव्वं तं सव्वं इध मज्झ पडिरूवे दिस्सउत्ति । णमो महति महापुरिसदिण्णाए अंगविज्जाए जं सव्वं तं सव्वं इध मज्झ पडिरूवे दिस्सउ । णमो अरहंताणं णमो सव्वसिद्धाणं सिद्धंतु मंता स्वाहा ॥ ४ ॥

(एसविज्जा छट्ठगहणी अट्ठमसाधणी जापो अट्ठसयं)

। पडिहारविज्जा-स्वरविज्जा ।

णमो अरिहंताणं णमो सव्वसिद्धाणं णमो सव्वसाहूणं णमो भगवतीए महापुरिस-दिण्णाए अंगविज्जाए उभयभए णतिभये भयमाभये भवे स्वाहा । स्वाहा डंडपडीहारो अंग-विज्जाए उदकजत्ताहिं चउहिं सिद्धिं ॥ णमो अरिहंताणं णमो सव्वसिद्धाणं णमो भगवईए महापुरिसदिण्णाए अंगविज्जाए भूमिकम्मं सव्वं भणंति । अरहंता ण मुसा भासंति । खत्तिया सव्वे णं अरहंता सिद्धा सव्वपडिहारे उ देवया अत्थ सव्वं कामसव्वं सव्वयं सव्वं तं इह दिसउत्ति । अंगविज्जाए इमा विज्जा उत्तमा लोकमाता बंभाए वाणपिया पयावइ अंगे एसा देवस्स सव्वअंगम्मि मे चक्खुं सव्वलोकम्मि य सव्वं पव्वज्जइसि सव्वं व जं भवे । एएण सव्ववइणेण इमो अट्ठो दिस्सउ । उंतं (उतं) पव्वज्जे । विजयं पव्वज्जे सव्वे पव्वज्जे उडुंवर-मूलीयं पव्वज्जे । पव्ववि (इ) स्सामि तं पव्वज्जे । मेघडंतीयं पव्वज्जं स्वरपितरं मातरं पव्वज्जे स्वरविज्जं पव्वज्जेति स्वाहा ॥ आभासो अभिमंतणं चउदकजत्ताहिं सिद्धं ॥ ५ ॥

। महाणिमित्तविज्जा ।

णमो अरिहंताणं णमो सव्वसिद्धाणं णमो केवलणाणीणं सव्वभावदंसीणं णमो आधो-धिकाणं णमो आभिवोधिकाणं (पव्वज्ज ?) णमो मणपज्जवणाणीणं णमो सव्वभावपवयण-पारगाणं बारसंगवीणं अट्ठमहाणिमित्तायरियाणं सुयणाणीणं णमो पण्णाणं णमो विज्जाचारण-सिद्धाणं तवसिद्धाणं चेव अणगार सुविहियाणं णिगंथाणं णमो महाणिमित्तीणंसव्वेसिं आयरियाणं णमो भगवओ जसचओ (? अरहओ) महावीरवद्धमाणस्स ॥ ६ ॥

श्री भैरवपद्मावतीकल्प





Nitya
नित्या

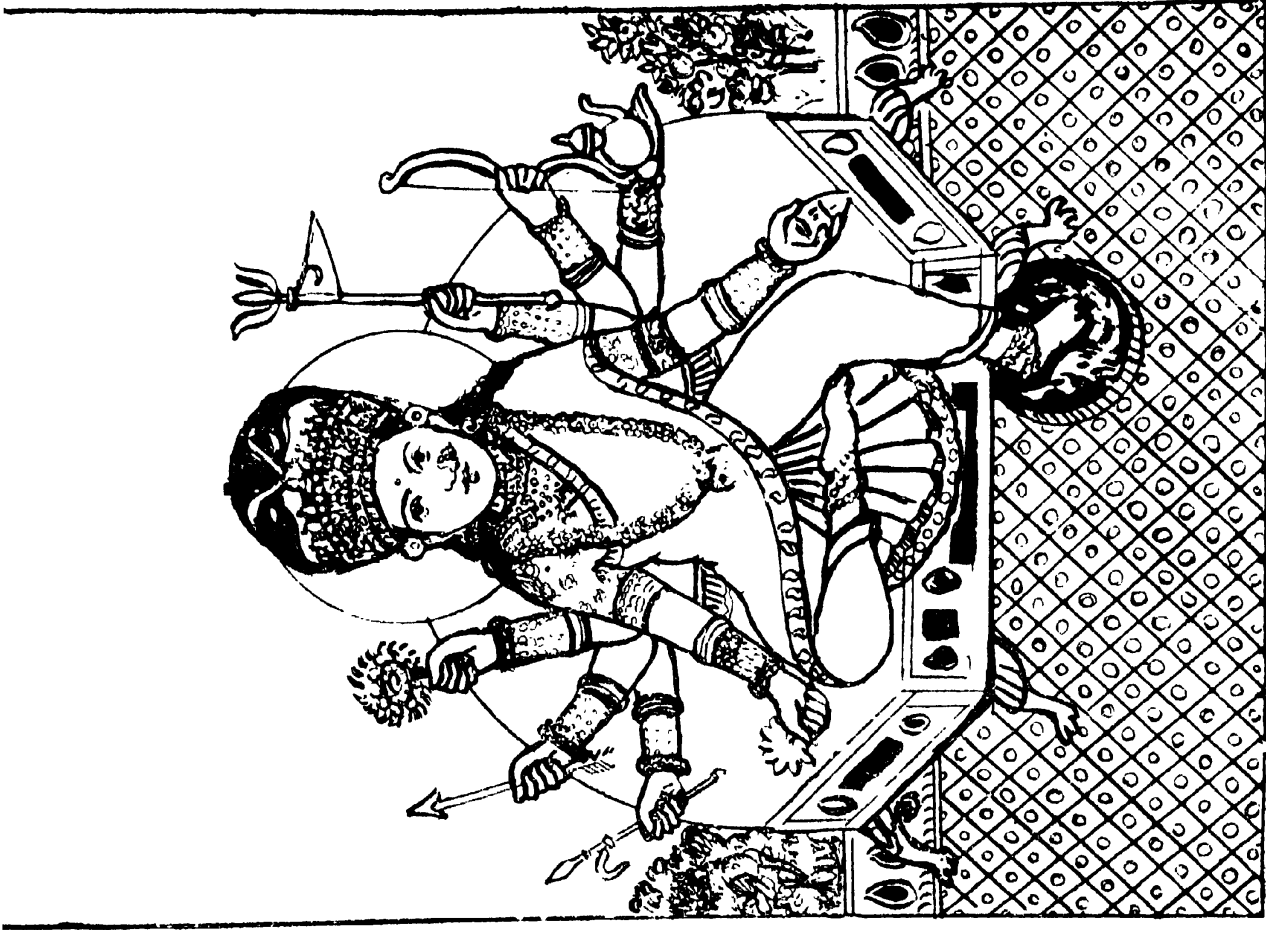

Tripura
त्रिपुरा

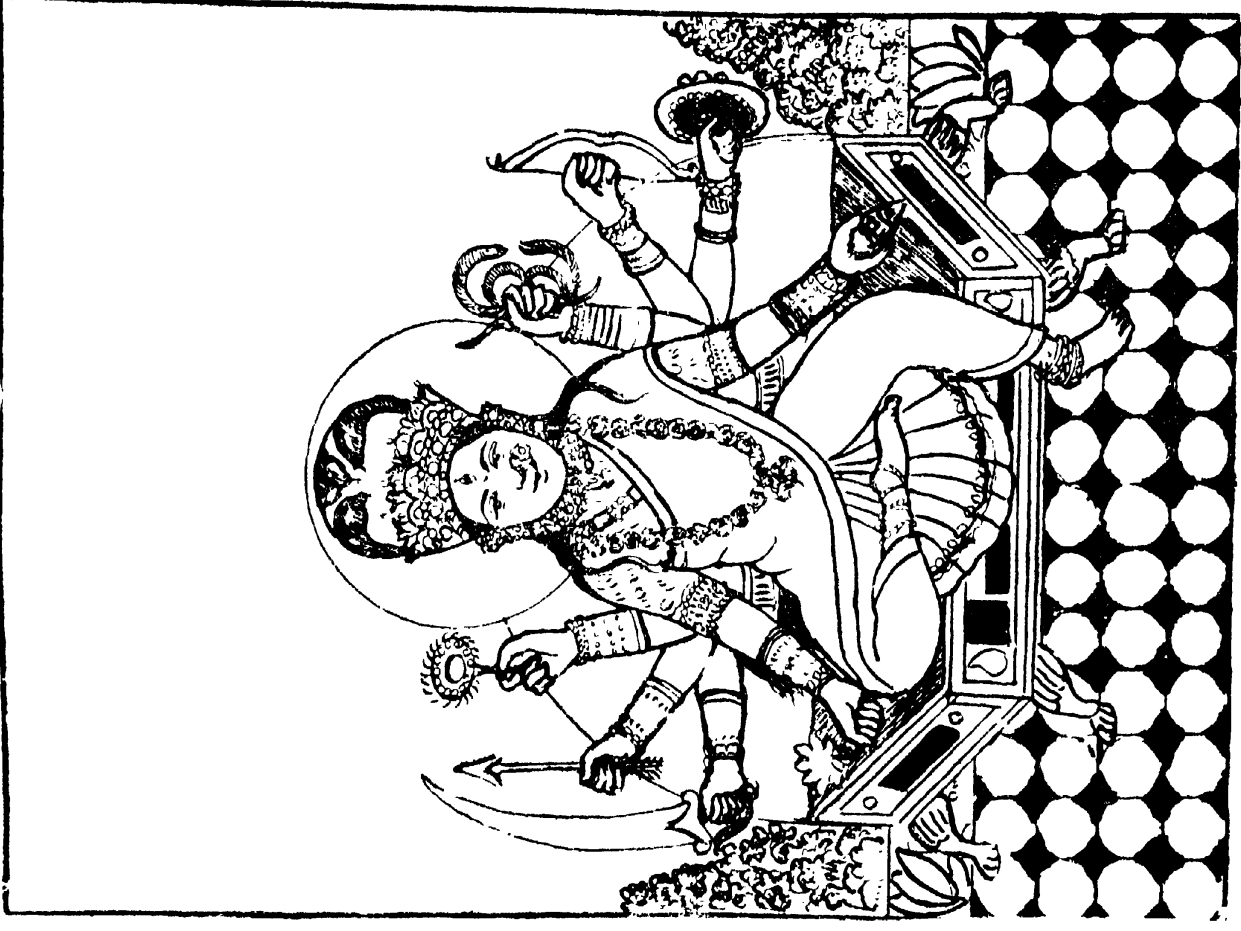

Tripurabhairavi
त्रिपुरभैरवी

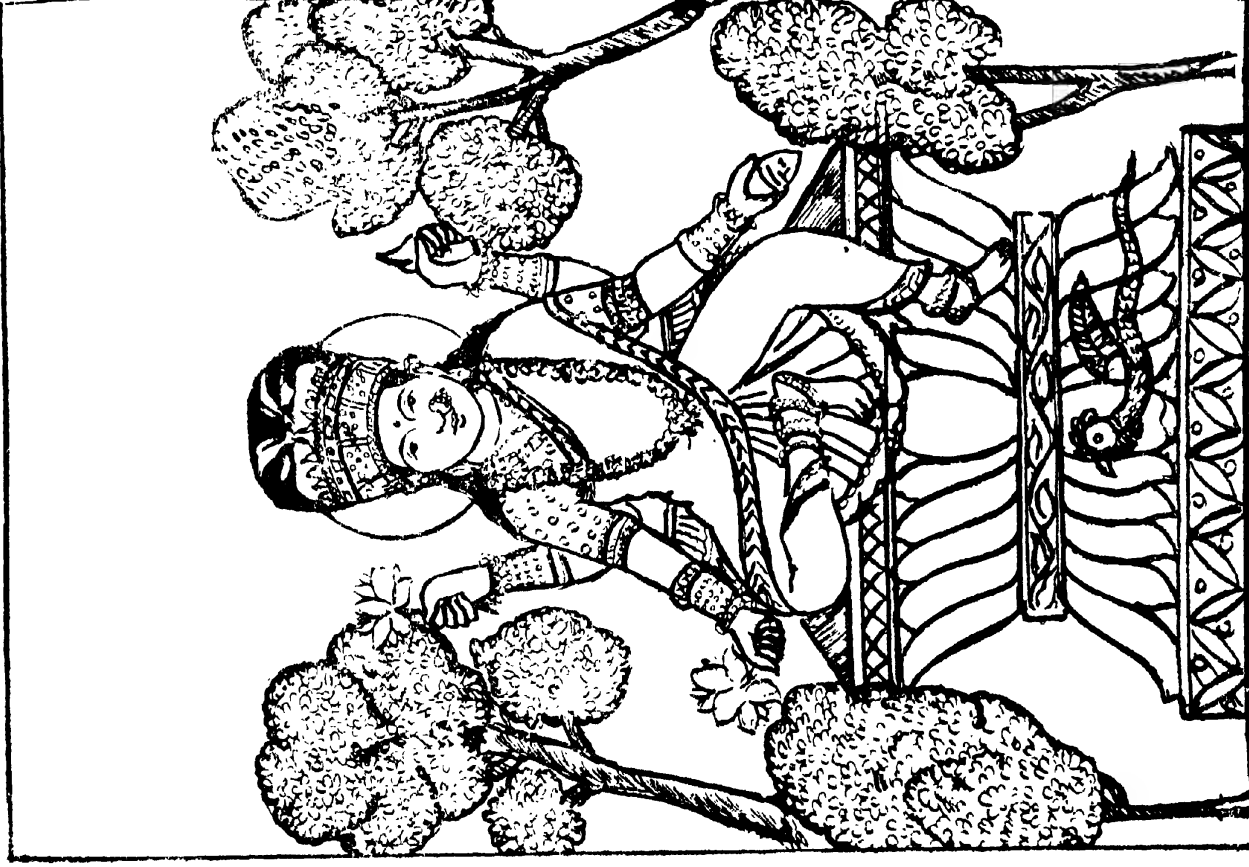

Kamasadhini
कामसाधिनी

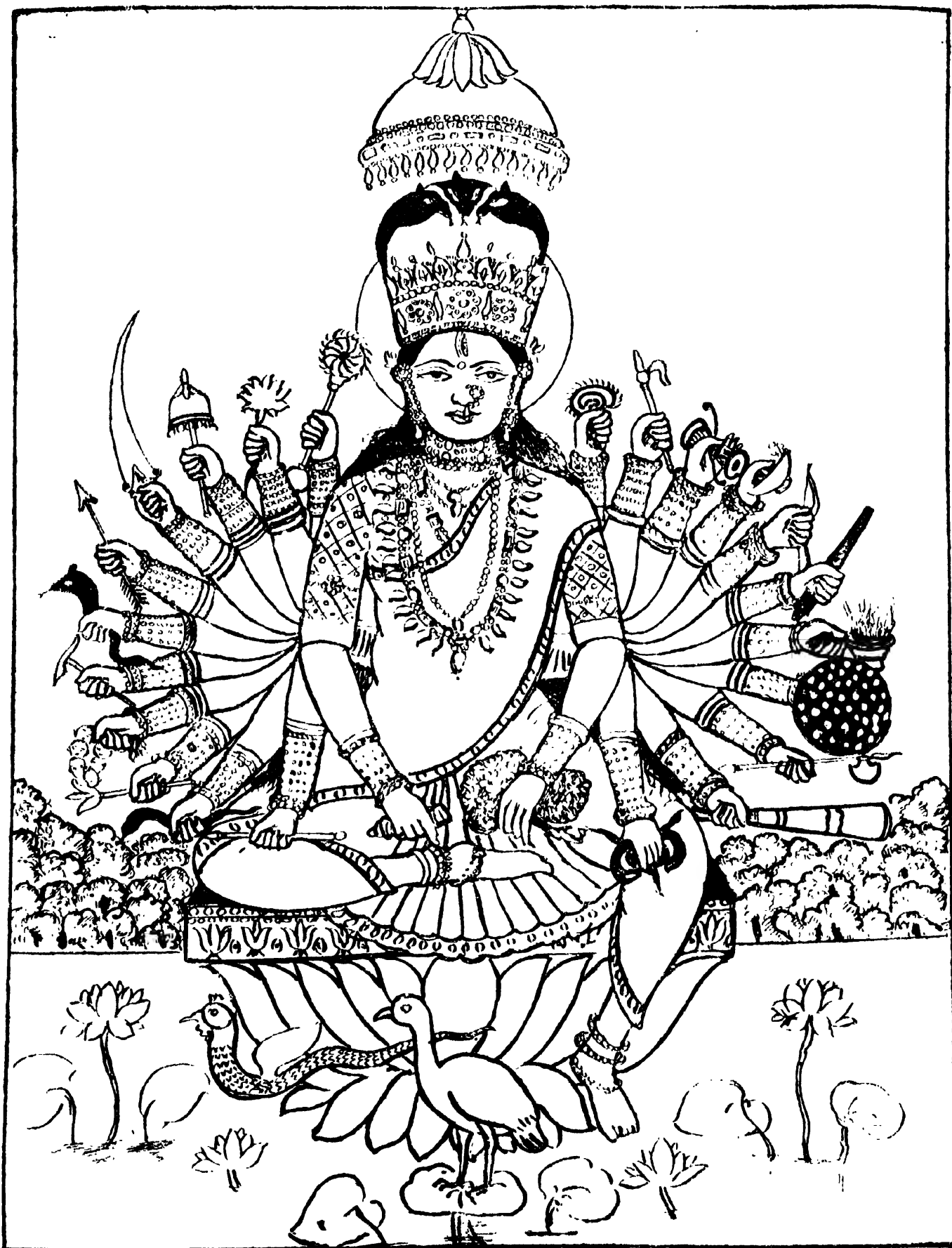

Goddess Padmavati with 24 hands
 चौवीस भुजावाळी पद्मावतीदेवी

॥ नै ह्रीं श्रीं पार्श्वनाथाय नमः ॥
 कविशेखरश्रीमल्लिषेणस्वरिविरचितः
 भैरवपद्मावतीकल्पः ।
 श्रीबन्धुषेणप्रणीतविवरणोपेतः ।
 प्रथमो मन्त्रिलक्षणाधिकारः

श्रीमन्चातुर्णिकायामरखचरवधूनृत्यसङ्गीतकीर्त्ति-
 व्यासाशामण्डलं मण्डितसुरपटहाद्यष्टसत्प्रातिहार्यम् ।
 नत्वा श्रीपार्श्वनाथं जितकमठकृतोद्दण्डघोरोपसर्गं
 पद्मावत्या हि कल्पप्रवरविवरणं वक्ष्यते बन्धुषेणैः ॥

कमठोपसर्गदलनं त्रिभुवननाथं प्रणम्य पार्श्वजिनम् ।
 वक्ष्येऽभीष्टफलप्रद-भैरवपद्मावतीकल्पम् ॥ १ ॥

‘कमठोपसर्गदलनं’ कमठेन कृतो य उपसर्गः तं दलयतीति कमठोपसर्गदलनः तं कमठोपसर्गदलनम् ।
 पुनः कथम्भूतम् ? ‘त्रिभुवननाथम्’ त्रिलोकाधीश्वरम् । कम् ? ‘पार्श्वजिनम्’ श्रीपार्श्वजिनेश्वरम् । किं कृत्वा ?
 ‘प्रणम्य’ प्रकर्षेण नमस्कृत्य, ‘वक्ष्ये’ प्रतिपादयिष्ये । कम् ? ‘भैरवपद्मावतीकल्पम्’ भैरवी चासौ पद्मावती च
 भैरवपद्मावती, तस्याः कल्पः भैरवपद्मावतीकल्पः, तं भैरवपद्मावतीकल्पम् । कथम्भूतम् ? ‘अभीष्टफलप्रदम्’
 अभिलषितं फलं प्रददातीति अभीष्टफलप्रदः तं अभीष्टफलप्रदं वक्ष्ये इति सम्बन्धः ॥ १ ॥

पाशफलवरदगजवशकरणकरा पद्मविष्टरा पद्मा ।
 सा मां रक्षतु देवी त्रिलोचना रक्तपुष्पाभा ॥ २ ॥

‘पाशफलवरदगजवशकरणकरा’ पाशश्च फलं च वरदश्च गजवशकरणं च पाशफलवरदगजवशकरणानि,
 तानि वामोर्ध्वकरादिक्रमेण विद्यन्ते यस्याः सा पाशफलवरदगजवशकरणकरा । पुनः कथम्भूता ? ‘पद्मविष्टरा’
 पद्ममेव विष्टरं-आसनं यस्याः सा पद्मविष्टरा । पुनः कथम्भूता ? ‘त्रिलोचना’ त्रीणि लोचनानि विद्यन्ते
 यस्याः सा त्रिलोचना । पुनः कथम्भूता ? ‘रक्तपुष्पाभा’ रक्तपुष्पवद् आभा-दीप्तिर्यस्याः सा रक्तपुष्पाभा ।
 का सा ? ‘पद्मा’ पद्मावती नाम । ‘देवी’ देवता । ‘मां’ ग्रन्थकर्तारं श्रीमल्लिषेणाचार्यं ‘रक्षतु’ पातु ॥ २ ॥

तोतला त्वरिता नित्या त्रिपुरा कामसाधिनी ।
 देव्या नामानि पद्मायास्तथा त्रिपुरभैरवी ॥ ३ ॥

तोतलादीनि त्रिपुरभैरवीपर्यन्तानि पद्मावतीदेव्याः पर्यायनामानि भवन्ति-जायन्ते ॥ ३ ॥

१ ‘रक्ताभा लोचनत्रितया’ इति ख पाठः

आदौ साधकलक्षणं सुसकलीं देव्यर्चनायाः क्रमं
 पश्चाद् द्वादशयन्त्रभेदकथनं स्तम्भोऽङ्गनाकर्षणम् ।
 यन्त्रं वश्यकं निमित्तमपरं वश्यौषधं गारुडं
 वक्ष्येऽहं क्रमशो यथा निगदिताः कल्पेऽधिकारास्तथा ॥ ४ ॥

प्रन्यस्यादौ 'साधकलक्षणं' मन्त्रसाधकानां लक्षणम् । 'सुसकलीम्' सम्यक्सकलीकरणक्रियाम् । 'देव्यर्चनायाः क्रमम्' देव्याराधनविधानम् । 'पश्चात्' देव्याराधनविधानानन्तरम् । 'द्वादशयन्त्रभेदकथनम्' द्वादशप्रकारयन्त्राणां भेदव्याख्यानम् । 'स्तम्भम्' क्रोधादिस्तम्भनयन्त्राधिकारम् । ['अङ्गनाकर्षणं' ह्याकर्षणाधिकारम् । 'यन्त्रं वश्यकं' वशीकरणयन्त्रनिरूपणाधिकारम् ।] 'निमित्तम्' दर्पणादिनिमित्ताधिकारम् । 'अपरं' अन्यत् । 'वश्यौषधं' ह्यादिवश्यौषधाधिकारम् । 'गारुडं' गारुडाधिकारम् । 'कल्पेऽधिकाराः' अस्मिन् कल्पे अधिकाराः 'यथा' येन प्रकारेण 'निगदिताः' प्रतिपादिताः 'तथा' तेन प्रकारेण 'अहं' श्रीमल्लिषेणाचार्यः 'क्रमशः' यथापरिपाठ्या 'वक्ष्ये' प्रतिपादयिष्ये ॥ ४ ॥

इति दशविधाधिकारैर्ललितार्याश्लोकगीतिसद्वृत्तैः ।
 विरचयति मल्लिषेणः कल्पं पद्मावतीदेव्याः ॥ ५ ॥

'इति दशविधाधिकारैः' इति—एवं प्राक्कथितदशप्रकाराधिकारैः। कथम्भूतैः? 'ललितार्याश्लोकगीतिसद्वृत्तैः' ललिता च सा आर्या च ललितार्या, श्लोकः—द्वात्रिंशदक्षरनिबद्धः, गीतीति उपगीतिः, सद्वृत्तैः—षड्विंशतिजातिवृत्तैः। 'विरचयति' विशेषेण रचयति। कः कर्ता? मल्लिषेणः। कम्? कल्पम्। कस्याः? 'पद्मावतीदेव्याः' भैरवपद्मावतीदेव्याः ॥ ५ ॥

निर्जितमदनाटोपः प्रशमितकोपो विमुक्तविकथालापः ।
 देव्यर्चनानुरक्तो जिनपदभक्तो भवेन्मन्त्री ॥ ६ ॥

'निर्जितमदनाटोपः' निःशेषेण जितो मदनस्य आटोपो—विजृम्भणं येन असौ निर्जितमदनाटोपः। 'प्रशमितकोपः' प्रकर्षेण शमितः कोपः येनासौ प्रशमितकोपः। 'विमुक्तविकथालापः' विशेषेण मुक्तः—त्यक्तः विकथाया आलापो विकथालापः—मिथ्यालापो येनासौ विमुक्तविकथालापः। 'देव्यर्चनानुरक्तः' देवी—पद्मावती तस्या अर्चने—पूजने अनुरक्तः। 'जिनपदभक्तः' श्रीजिनेश्वरपदकमलभक्तः। असौ 'मन्त्री' मन्त्रवादी एवंगुणयुक्तो 'भवेत्' स्यात् ॥ ६ ॥

मन्त्राराधनशूरः पापविदूरो गुणेन गम्भीरः ।
 मौनी महाभिमानी मन्त्री स्यादीदृशः पुरुषः ॥ ७ ॥

मन्त्रस्याराधनं मन्त्राराधनं तस्मिन् शूरः—निर्भयः असौ मन्त्राराधनशूरः। पुनः कथम्भूतः? 'पापविदूरः' दुष्कर्मकरणविदूरः। 'गुणेन गम्भीरः' सकलगुणैः कृत्वा गम्भीरः। मौनं विद्यते यस्यासौ मौनी। 'महाभिमानी' महांश्चासौ अभिमानश्च महाभिमानः, स विद्यते यस्यासौ महाभिमानी। 'ईदृशः पुरुषः' एवंगुणविशिष्टः पुमान्। 'मन्त्री' मन्त्रवादी स्यात् ॥ ७ ॥

गुरुजनहितोपदेशो गततन्द्रो निद्रया परित्यक्तः ।

परिमितभोजनशीलः स स्यादाराधको देव्याः ॥ ८ ॥

‘गुरुजनहितोपदेशः’ गुरुजनेभ्यः सकाशाद् हितः—आहितः उपदेशो येन असौ गुरुजनहितोपदेशः । ‘गततन्द्रः’ निरालस्यः । ‘निद्रया परित्यक्तः’ अतिनिद्रया रहितः । ‘परिमितभोजनशीलः’ परिमितं भोजनं शीलं यस्य असौ परिमितभोजनशीलः । ‘सः’ एवंगुणविशिष्टः पुरुषः । ‘देव्याः’ पद्मावत्याः । ‘आराधकः’ साधकः । ‘स्यात्’ भवेत् ॥ ८ ॥

निर्जितविषयकषायो धर्मामृतजनितहर्षगतकायः ।

गुरुतरगुणसम्पूर्णः स भवेदाराधको देव्याः ॥ ९ ॥

‘निर्जितविषयकषायः’ विषयाः पञ्चेन्द्रियजादयः, कषायाः क्रोधादयः, विषयाश्च कषायाश्च विषयकषायाः निर्जिता विषयकषाया येन असौ निर्जितविषयकषायः । पुनः कथम्भूतः? ‘धर्मामृतजनितहर्षगतकायः’ धर्म एवामृतं धर्मामृतं, तेन जनितो हर्षः धर्मामृतजनितहर्षः, धर्मामृतजनितहर्ष गतः—प्राप्तः कायः—शरीरं यस्यासौ धर्मामृतजनितहर्षगतकायः । ‘गुरुतरगुणसम्पूर्णः’ विशिष्टतरगुणैः सम्पूर्णः । ‘स भवेदाराधको देव्याः’ स एवंगुणविशिष्टः पुरुषः देव्याः—पद्मावत्या आराधको भवेत्—स्यात् ॥ ९ ॥

शुचिः प्रसन्नो गुरुदेवभक्तो दृढव्रतः सत्यदयासमेतः ।

दक्षः पटुर्बीजपदावधारी मन्त्री भवेदीदृश एव लोके ॥ १० ॥

‘शुचिः’ बाह्याभ्यन्तरशुचिः । ‘प्रसन्नः’ सौम्यचित्तः । ‘गुरुदेवभक्तः’ गुरुदेवेषु भक्तः । ‘दृढव्रतः’ गृहीत-व्रतेष्वतिदृढः । ‘सत्यदयासमेतः’ अननृतवाक्यदयासमेतः । ‘दक्षः’ अतिचतुरः । ‘पटुः’ मेधावी । ‘बीजपदावधारी’ बीजाक्षरपदावधारणं विद्यते यस्यासौ बीजपदावधारी । ‘ईदृशः’ एवंविध एव पुरुषः । ‘लोके’ लोकमध्ये । ‘मन्त्री’ मन्त्रवादी ‘भवेत्’ स्यात् ॥ १० ॥

एते गुणा यस्य न सन्ति पुंसः क्वचित् कदाचिन्न भवेत् स मन्त्री ।

करोति चेदर्पवशात् स जाप्यं प्राप्नोत्यनर्थं फणिशेखरायाः ॥ ११ ॥

‘एते गुणा यस्य न सन्ति पुंसः’ यस्य पुरुषस्य एते गुणा न सन्ति—न विद्यन्ते । ‘क्वचित्’ यत्र क्वापि प्रदेशे । ‘कदाचित्’ कस्मिंश्चित् काले । ‘सः’ एवंविशिष्टः पुमान् । ‘मन्त्री’ मन्त्रवादी । ‘न भवेत्’ न स्यात् । ‘सः’ पुरुषः । ‘दर्पवशात्’ उद्धतवृत्त्या । ‘जाप्यं’ मन्त्रजाप्यं । ‘करोति चेत्’ यदि करोति । ‘प्राप्नोत्यनर्थं फणिशेखरायाः’ पद्मावती-देव्याः सकाशाद् अनर्थं प्राप्नोति—आपद्यते ॥ ११ ॥

इत्युभयभाषाकविशेखरश्रीमल्लिषेणसूरिविरचिते भैरवपद्मावतीकल्पे

मन्त्रिलक्षणाधिकारः प्रथमः ॥ १ ॥

‘इति’ एवं ‘श्रीमल्लिषेणसूरिविरचिते’ श्रिया उपलक्षितो मल्लिषेणः श्रीमल्लिषेणः स चासौ सूरिश्च श्रीमल्लिषेणसूरिः तेन विरचितः—कथितः तस्मिन् श्रीमल्लिषेणसूरिविरचिते । क्व ? भैरवपद्मावतीकल्पे’ भैरव-पद्मावतीदेव्याः मन्त्रकल्पे मन्त्रिलक्षणाधिकारः प्रथमः ॥ १ ॥

द्वितीयः सकलीकरणपरिच्छेदः

स्नात्वा पूर्वं मन्त्री प्रक्षालितरक्तवस्त्रपरिधानः ।

सम्मार्जितप्रदेशे स्थित्वा सकलीक्रियां कुर्यात् ॥ १ ॥

‘स्नात्वा’ स्नानं कृत्वा । ‘पूर्वं’ प्राक् । ‘मन्त्री’ मन्त्रवादी । ‘प्रक्षालितरक्तवस्त्रपरिधानः’ धौतलोहितवस्त्र-परिधानः । ‘सम्मार्जितप्रदेशे’ गोमयलिप्तप्रदेशे । ‘स्थित्वा’ उषित्वा । ‘सकलीक्रियां’ आत्मरक्षाविधानं कुर्यात् ॥ १ ॥

ह्रौं वामकराङ्गुष्ठे तर्जन्यां ह्रीं च मध्यमायां ह्रूं ।

ह्रौं पुनरनामिकायां कनिष्ठिकायां च ह्रः सुस्यात् ॥ २ ॥

‘ह्रौं वामकराङ्गुष्ठे’ वामकराङ्गुष्ठाग्रे ह्रामिति बीजं विन्यसेत् । ‘तर्जन्यां ह्रौं’ तर्जन्यङ्गुल्यग्रे ह्रीमिति बीजम् । ‘मध्यमायां ह्रूं’ मध्यमाङ्गुल्यग्रे ह्रूमिति बीजम् । ‘ह्रौं पुनरनामिकायाम्’ पुनः—पश्चाद् अनामिकाङ्गुल्यग्रे ह्रीमिति बीजम् । ‘कनिष्ठिकायां च हः’ कनिष्ठिकाङ्गुल्यग्रे हः इति बीजम्, चः समुच्चये । एवं यथानुक्रमेण पञ्चशून्य-बीजस्थापना स्यात्—भवेत् । ह्रौं ह्रौं ह्रूं ह्रौं ह्रः अङ्गुल्यग्रेषु न्यासाक्षराणि ॥ २ ॥

पञ्चनमस्कारपदैः प्रत्येकं प्रणवपूर्वहोमान्त्यैः ।

पूर्वोक्तपञ्चशून्यैः परमेष्ठिपदाग्रविन्यस्तैः ॥ ३ ॥

शीर्षं वदनं हृदयं नाभिं पादौ च रक्ष रक्षेति ।

कुर्यादेतैर्मन्त्री प्रतिदिवसं स्वाङ्गविन्यासम् ॥ ४ ॥ कुलकम् ॥

‘पञ्चनमस्कारपदैः’ अर्हत्सिद्धाचार्योपाध्यायसर्वसाधूनां नमस्कारपूर्वं पञ्चपदैः । कथम्भूतैः ? ‘प्रत्येकं प्रणव-पूर्वहोमान्त्यैः’ पृथक् पृथक् उकारपूर्वस्वाहाशब्दान्तैः । कथम्भूतैः ? ‘परमेष्ठिपदाग्रविन्यस्तैः’ पञ्चपरमेष्ठिनां पदाग्रे यथानुक्रमेण विशेषेण न्यस्तैः [कैः ‘पूर्वोक्तपञ्चशून्यैः’ पूर्वोक्तैः ह्रौं ह्रौं ह्रूं ह्रौं ह्रः इतिरूपैः पञ्चभिः शून्यैः—हकारैः] ॥ ३ ॥

‘शीर्षं’ मस्तकम् । ‘वदनं’ आस्यम् । ‘हृदयं’ हृत्स्थानम् । ‘नाभिं’ नाभिस्थानम् । ‘पादौ’ चरणद्वयम् । ‘चः’ समुच्चये । ‘रक्ष रक्ष इति’ पदद्वयं । अनेन प्रकारेण ‘एतैः’ कथितमन्त्रैः । ‘मन्त्री’ मन्त्रवादी । ‘प्रतिदिवसं’ दिनं दिनं प्रति । ‘स्वाङ्गविन्यासं’ स्वकीयाङ्गन्यासम् । ‘कुर्यात्’ करोतु ॥ ४ ॥

ॐ नमो अरिहंताणं ह्रौं शीर्षं रक्ष रक्ष स्वाहा । ॐ नमो सिद्धाणं ह्रौं वदनं रक्ष रक्ष स्वाहा । ॐ नमो आयरियाणं ह्रूं हृदयं रक्ष रक्ष स्वाहा । ॐ नमो उवज्जायाणं ह्रौं नाभिं रक्ष रक्ष स्वाहा । ॐ नमो लोए सव्वसाहूणं ह्रः पादौ रक्ष रक्ष स्वाहा ॥ इत्यङ्गन्यासक्रमः ॥

द्विचतुःषष्ठचतुर्दशकलाभिरन्त्यस्वरेण विन्दुयुतैः ।

कूटैर्दिग्बन्धनं कुर्यात् ॥ ५ ॥

‘द्विचतुःषष्टचतुर्दशकलाभिः’ द्विकलः—आकारः, चतुःकलः—ईकारः, षष्टकलः—ऊकारः, चतुर्दशकलः—
 औकारः, एभिः द्विचतुःषष्टचतुर्दशकलादिभिः स्वरैः । कथम्भूतैः ? ‘अन्त्यस्वरेण बिन्दुयुतैः’ अन्त्यस्वरः—अंकारः
 तेन अन्त्यस्वरेण बिन्दुः—अनुस्वारः तेन युतैः । कैः ? कूटैः—क्षकारैः । कथम्भूतैः ? ‘दिग्विन्यस्तैः’ दिशि न्यस्तैः ।
 कासु ? दिशासु । ‘दिग्बन्धनं कुर्यात्’ दिशां बन्धनं कुर्यात् । उद्धारः—क्षां क्षीं क्षूं क्षीं क्षः ॥ ५ ॥

हेममयं प्राकारं चतुरस्रं चिन्तयेत् समुत्तुङ्गम् ।

विंशतिहस्तं मन्त्री सर्वस्वरसंयुतैः शून्यैः ॥ ६ ॥

‘हेममयं’ स्वर्णमयम् । कम् ? ‘प्राकारं’ दुर्गम् । कथम्भूतम् ? ‘चतुरस्रम्’ चतुःकोणम् । पुनः कथम्भूतम् ?
 ‘समुत्तुङ्गम्’ सम्यग् उन्नतम् । पुनः किंविशिष्टम् ? ‘विंशतिहस्तं’ विंशतिहस्तप्रमाणम् । ‘सर्वस्वरसंयुतैः शून्यैः’
 हकारैः । ‘मन्त्री’ मन्त्रवादी । ‘चिन्तयेत्’ एवंगुणविशिष्टं प्राकारं ध्यायेत्—ध्यानं कुर्यात् ॥ ६ ॥

सर्वस्वरसम्पूर्णैः कूटैरपि खातिकाकृतिं ध्यायेत् ।

निर्मलजलपरिपूर्णामतिभीषणजलचराकीर्णाम् ॥ ७ ॥

‘सर्वस्वरसम्पूर्णैः’ । कैः ? ‘कूटैः’ क्षकारैः । ‘अपि’ निश्चये । ‘खातिकाकृतिं’ परिखाकारम् । ‘ध्यायेत्’ ध्यानं
 कुर्यात् । कथम्भूताम् ? ‘निर्मलजलपरिपूर्णाम्’ । पुनः कथम्भूताम् ? ‘अतिभीषणजलचराकीर्णाम्’ अतिभयानक-
 मत्स्यमकरनक्रकच्छपादिजलचरपरिपूर्णाम् ॥ ७ ॥

ज्वलदोङ्काररकारज्वालादग्धं स्वमग्निपुरसंस्थम् ।

ध्यात्वाऽमृतमन्त्रेण स्नानं पश्चात् करोत्वमुना ॥ ८ ॥

‘ज्वलदोङ्काररकार०’ जाज्वल्यमान उकारः, रकाराक्षराणि, तेषां ज्वालाभिर्दग्धः तं ज्वलदोङ्काररकार-
 ज्वालादग्धम् । कम् ? ‘स्वम्’ आत्मानम् । कथम्भूतम् ? ‘अग्निपुरसंस्थम्’ अग्निमण्डलमध्यस्थम् । ‘ध्यात्वा’
 ध्यानं कृत्वा । ‘पश्चात्’ ध्यानानन्तरम् । ‘अमुना’ अनेन । ‘अमृतमन्त्रेण’ वक्ष्यमाणमन्त्रेण । ‘स्नानम्’ मन्त्रस्नानम् ।
 ‘करोतु’ कुर्यात् ॥ ८ ॥

मन्त्रः—ॐ अमृते ! अमृतोद्भवे ! अमृतवर्षिणि ! अमृतं स्रावय स्रावय सं सं क्लीं क्लीं हूं हूं ह्रां ह्रां
 ह्रीं ह्रीं द्रावय द्रावय ह्रीं स्वाहा ॥ अमृतमन्त्रोऽयम् ॥

निजोत्तमाङ्गामरभूधराग्रे संस्नापितः पार्श्वजिनेन्द्रचन्द्रः ।

क्षीराब्धिदुग्धेन सुरेन्द्रवृन्दैः स्वं चिन्तयेत् तज्जलशुद्धगात्रम् ॥ ९ ॥

‘निजोत्तमाङ्गामरभूधराग्रे’ स्वकीयोत्तमाङ्गमेव अमरभूधरः—मेरुः तस्याग्रं—शिखरं तस्मिन् निजोत्तमाङ्गामर-
 भूधराग्रे । ‘संस्नापितः’ सम्यक् स्नापितः । कः ? ‘जिनेन्द्रचन्द्रः पार्श्वः’ । केन ? ‘क्षीराब्धिदुग्धेन’ क्षीरसमुद्रदुग्धेन । कैः ?
 ‘सुरेन्द्रवृन्दैः’ देवेन्द्रवृन्दैः । ‘स्वं चिन्तयेत्’—आत्मानं ध्यायेत् । ‘तज्जलशुद्धगात्रम्’ तत्स्नानोदकेन शुद्धं शरीरं
 यथा भवति ॥ ९ ॥

१ “ऴँ ऴँ” इति ख पाठः । २ ज्वी क्ष्वी हं सः इति ख पाठः । ३ “धौतः” इति ख पाठः

भूतग्रहशाकिन्यो ध्यानेनानेन नोपसर्पन्ति ।

अपहरति पूर्वसञ्चितमपि दुरितं त्वरितमेवेह ॥ १० ॥

‘भूतग्रहशाकिन्यः’ भूतानि च प्रहाश्च शाकिन्यश्च भूतग्रहशाकिन्यः । ‘ध्यानेनानेन’ अनेन कथितध्यानेन । ‘नोपसर्पन्ति’ उपसर्पणं कर्तुं न शक्नुवन्ति । ‘पूर्वसञ्चितमपि’ प्राग्जन्मोपाजितमपि । किं तत् ? ‘दुरितम्’ दुःकर्म । ‘त्वरितमेव’ शीघ्रमेव । ‘अपहरति’ नाशयति ॥ १० ॥

पर्यङ्कासनसंस्थः समीपतरवर्तिपूजनद्रव्यः ।

दिग्वनितानां तिलकं स्वस्य च कुर्यात् सुचन्दनतः ॥ ११ ॥

‘पर्यङ्कासनसंस्थः’ पत्यङ्कासने संस्थः । ‘समीपतरवर्तिपूजनद्रव्यः’ स्वपार्श्वस्थापिताष्टविधपूजोपकरणद्रव्यः । ‘दिग्वनितानां तिलकं’ पूर्वाद्यष्टदिग्वधूनां तिलकं-विशेषकम् । ‘स्वस्य च’ आत्मनश्चापि । ‘सुचन्दनतः’ शोभनेन चन्दनेना तिलकं ‘कुर्यात्’ करोतु ॥ ११ ॥

पन्नगाधिपशेखरां विपुलारुणाम्बुजविष्टरां

कुर्कुटोरगवाहनामरुणप्रभां कमलाननाम् ।

त्र्यम्बकां वरदाङ्कुशायतपाशदिव्यफलाङ्कितां

चिन्तयेत् कमलावतीं जपतां सतां फलदायिनीम् ॥ १२ ॥

‘पन्नगाधिपशेखरां’ पन्नगानां अधिपः पन्नगाधिपः-धरणेन्द्रः शेखरे-मुकुटाग्रे विद्यते यस्याः सा पन्नगाधिपशेखरा, ताम् । किंविशिष्टाम् ? ‘विपुलारुणाम्बुजविष्टराम्’ विपुलं-विस्तीर्णं अरुणाम्बुजमेव विष्टरं-आसनं यस्याः सा विपुलारुणाम्बुजविष्टरा ताम् । पुनः किंविशिष्टाम् ? ‘कुर्कुटोरगवाहनाम्’ कुर्कुटसर्पवाहनाम् । पुनः किंविशिष्टाम् ? ‘अरुणप्रभां’ सिन्दूरवत् प्रभा-दीप्तिर्विद्यते यस्याः सा ताम् । पुनः किंविशिष्टाम् ? ‘कमलाननाम्’ कमलवद् आननं मुखं यस्याः सा कमलाननां ताम् । ‘त्र्यम्बकाम्’ त्रीणि अम्बकानि-लोचनानि विद्यन्ते यस्याः सा त्र्यम्बका ताम् । पुनः किंविशिष्टाम् ? ‘वरदाङ्कुशायतपाशदिव्यफलाङ्किताम्’ वरदश्च अङ्कुशश्च आयत-पाशश्च दिव्यफलं च वरदाङ्कुशायतपाशदिव्यफलानि तैः अङ्किताः-चिह्निताः करा यस्याः सा वरदाङ्कुशायत-पाशदिव्यफलाङ्किता ताम् । ‘चिन्तयेत्’ ध्यानं कुर्यात् । काम् ? ‘कमलावतीम्’ पद्मावतीम् । किंविशिष्टाम् ? ‘जपतां’ जाप्यं कुर्वतां ‘सतां’ सत्पुरुषाणां ‘फलदायिनीं’ फलं ददातीति तां फलदायिनीम् ॥ १२ ॥

परिज्ञायांशकं पूर्वं साध्यसाधकयोरपि ।

मन्त्रं निवेदयेत् प्राज्ञो व्यर्थं तत्फलमन्यथा ॥ १३ ॥

‘परिज्ञाय’ सम्यग् ज्ञात्वा । किम् ? ‘अंशकं’ मात्रांशकम् । ‘पूर्वं’ प्राक् । कयोः ? ‘साध्यसाधकयोः’ साध्यः-मन्त्रः, साधकः-मन्त्री तयोः साध्यसाधकयोः । ‘अपि’ निश्चयेन । ‘मन्त्रं निवेदयेत्’ मन्त्रोपदेशं कुर्यात् ।

‘प्राज्ञो’ धीमान् । ‘अन्यथा’ अंशकज्ञानाभावे । ‘तत्फलं’ तस्य मन्त्रस्य फलम् । ‘व्यर्थं’ निरर्थकं भवेत् ॥ १३ ॥

साध्यसाधकयोर्नामानुस्वारव्यञ्जनस्वरम् ।

पृथक् कृत्वा क्रमात् स्थाप्यमूर्ध्वाधःप्रविभागतः ॥ १४ ॥

‘साध्यसाधकयोर्नाम’ साध्यो-मन्त्रः साधको-मन्त्री तयोर्नाम । ‘अनुस्वारं,’ ‘व्यञ्जनं’ ककारादिवर्णान् ‘स्वरं’ अकारादिस्वरान् । ‘पृथक् कृत्वा’ पृथग् विश्लेष्य । ‘क्रमात् स्थाप्यम्’ साध्यसाधकपरिपाटया संस्थाप्यम् । कथम्? ‘ऊर्ध्वाधःप्रविभागतः’ साध्यनाम ऊर्ध्वतः साधकनाम अधः कृत्वा अनेन प्रविभागक्रमेण स्थापयेत् ॥ १४ ॥

साध्यनामाक्षरं गण्यं साधकाह्वयवर्णतः ।

नपुंसकं परित्यज्य कुर्यात् तद् वेदभाजितम् ॥ १५ ॥

[‘साध्यनामाक्षरं’ साध्यनामवर्णान् । ‘साधकाह्वयवर्णतः’ साधकनामाक्षरेभ्यः । ‘गण्यं’ गणयेत् ।] किं कृत्वा? ‘नपुंसकं’ ‘परित्यज्य’ ऋ ऋ लृ लृ इति नपुंसकानि परित्यज्य । ‘तद् वेदभाजितं’ तत्-साध्यसाधकयोरनुस्वारव्यञ्जनगण्यमानराशिं वेदभाजितं-चतुर्भाजितं कुर्यात् ॥ १५ ॥

आयो भागोद्धरितं तं चाद्यं स्थापयेत् क्रमाद् धीमान् ।

एकद्वित्रिचतुर्वर्णान् सिद्धं साध्यं सुसिद्धमरिः ॥ १६ ॥

‘आयो भागोद्धरितं’ प्रकृतसाध्यसाधकराशौ चतुर्भिर्भागि हृते यद् उद्धरितं स आयः । ‘तं च’ उद्धरितं आयं च । ‘आद्यं स्थापयेत्’ विश्लेषितसाध्यमात्रानुस्वारव्यञ्जनपङ्क्तौ आदौ स्थापयेत् । कथम्? ‘क्रमात्’ पङ्क्तौ यथानुक्रमेण । कः? धीमान् । ‘एकद्वित्रिचतुर्वर्णान् सिद्धं साध्यं सुसिद्धं अरिः’ एक उद्धरिते सिद्धम्, द्विरुद्धरिते साध्यम्, त्रिरुद्धरिते सुसिद्धम्, चतुरुद्धरिते शत्रुः इत्येवं ज्ञातव्यम् ॥ १६ ॥

सिद्धसुसिद्धं ग्राह्यं साध्यं शत्रुं च वर्जयेद् धीमान् ।

सिद्धसुसिद्धे फलदे विफलं साध्ये रिपौ^३ वाऽऽये ॥ १७ ॥

‘सिद्धसुसिद्धं ग्राह्यं’ चतुरायमध्ये सिद्धसुसिद्धं इत्यायद्वयं ग्राह्यम् । ‘साध्यं शत्रुं च वर्जयेत्’ तदायमध्ये साध्यं शत्रुं च इत्यायद्वयं वर्जयेत् । कः? ‘धीमान्’ बुद्धिमान् । ‘सिद्धसुसिद्धं फलदे’ सिद्धसुसिद्धं इत्यायद्वये सफले मन्त्रस्य फलं भवति । ‘विफलं साध्ये रिपौ वाऽऽये’ साध्ये रिपौ वा आयद्वये मन्त्रं विफलं स्यात् ॥ १७ ॥

फलदं कतिपयदिवसैः सिद्धं चेत् साध्यमपि दिनैर्बहुभिः ।

शटिति फलदं सुसिद्धं प्राणार्थविनाशनः शत्रुः ॥ १८ ॥

‘सिद्धं चेत्’ सिद्धं मन्त्रं चेत् । ‘कतिपयदिवसैः’ कियद्भिर्वासरैः । ‘फलदं’ फलदायकं भवति । ‘साध्यमपि दिनैर्बहुभिः’ अपि—पश्चात् साध्यं मन्त्रं बहुभिर्दिनैः फलदं भवति । ‘झटिति फलदं सुसिद्धं’ सुसिद्धं मन्त्रं झटिति शीघ्रं फलदायकं भवति । ‘प्राणार्थविनाशनः शत्रुः’ शत्रुर्मन्त्रं प्राणार्थविनाशकरो भवति ॥ १८ ॥

आदावन्ते शत्रुर्यदि भवति तदा परित्यजेन्मन्त्रम् ।

स्थानत्रितये शत्रुर्मृत्युः स्यात् कार्यहानिर्वा ॥ १९ ॥

‘आदावन्ते शत्रुर्यदि भवति’ मन्त्रस्यादौ मन्त्रान्ते यदि शत्रुर्भवति ‘तदा परित्यजेन्मन्त्रम्’ मन्त्रं परिवर्जयेत् । ‘स्थानत्रितये शत्रुर्मृत्युः स्यात्’ आदिमध्यावसाने यदि शत्रुर्भवति मन्त्रस्य तदा मृत्युर्भवति ‘कार्यहानिर्वा’ कार्यनाशो वा भवति ॥ १९ ॥

शत्रुर्भवति यदाऽऽदौ मध्ये सिद्धं तदन्तगं साध्यम् ।

कष्टेन भवति महता स्वल्पफलं चेति कथनीयम् ॥ २० ॥

‘शत्रुः’ इत्यादि । यदा आयगणने प्रथमतः शत्रुर्भवति, मन्त्रस्य मध्ये सिद्धं भवति । ‘तदन्तगं साध्यं’ मन्त्रस्यान्तगं साध्यं चेत् । ‘कष्टेन भवति महता’ महता—अत्यन्तक्लेशेन जायते स्वल्पफलम् । चः समुच्चये । ‘इति’ अनेन प्रकारेण कथनीयम् ॥ २० ॥

अन्ते यदि भवति रिपुः प्रथमे मध्ये च सिद्धयुगपतनम् ।

कार्यं यदादिजातं तन्नश्यति सर्वमेवान्ते ॥ २१ ॥

‘अन्ते यदि भवति रिपुः’ मन्त्रस्यान्ते यदि शत्रुर्भवति । ‘प्रथमे मध्ये च सिद्धयुगपतनम्’ मन्त्रादौ मन्त्रमध्ये च सिद्धयुगपतो यदि भवति । ‘कार्यं यदादिजातं’ एवंविधमन्त्रे यत् पूर्वं जातं कार्यं अमितफलं ‘तन्नश्यति सर्वमेवान्ते’ तत्—कार्यं जनितफलं सर्वमेवान्ते—अवसाने नाशं प्राप्नोति ॥ २१ ॥

सिद्धं सुसिद्धमथवा रिपुणाऽन्तरितं निरीक्ष्यते यत्र ।

दुःखापायप्रबलं भवतीति विवर्जयेत् कार्यम् ॥ २२ ॥

‘अथवा’ अन्यप्रकारेण । सिद्धं सिद्धपदम् । सुसिद्धं सुसिद्धपदम् । ‘रिपुणाऽन्तरितं’ शत्रुपदान्तरितं यदि ‘निरीक्ष्यते यत्र’ यस्मिन् मन्त्रे निरीक्ष्यते—दृश्यते तदा ‘दुःखापायप्रबलं’ क्लेशानर्थप्रचुरं भवति ‘इति’ एवं ज्ञात्वा ‘विवर्जयेन्मन्त्रं’ साधनकार्यं परिवर्जयेत् ॥ २२ ॥

इत्युभयभाषाकविशेखरश्रीमल्लिषेणसूरिविरचिते भैरवपद्मावतीकल्पे

सकलीकरणं नाम द्वितीयः परिच्छेदः ॥ २ ॥

तृतीयो देव्यर्चनाक्रमपरिच्छेदः । ३

दीपन-पल्लव-सम्पुट-रोध-ग्रथना-विदर्भणैः कुर्यात् ।

शान्ति-द्वेष-वशीकृत-बन्ध-ख्याकृष्टि-संस्तम्भम् ॥ १ ॥

‘दीपन’ दीपनेन शान्तिकं कुर्यात्, ‘पल्लव’ पल्लवेन विद्वेषणं कुर्यात्, ‘सम्पुट’ सम्पुटेन वश्यं कुर्यात्, ‘रोधन’ रोधनेन बन्धं कुर्यात्, ‘ग्रथना’ ग्रथनया ख्याकृष्टिं कुर्यात्, ‘विदर्भण’ विदर्भणेन क्रोधादि-स्तम्भं कुर्यात् ॥ १ ॥

अथ दीपनादीनां व्याख्या—

आदौ नामनिवेशो दीपनमन्ते च पल्लवो ज्ञेयः ।

तन्मध्यगतं सम्पुटमथादिमध्यान्तगो रोधः ॥ २ ॥

ग्रथनं वर्णान्तरितं द्व्यक्षरमध्यस्थितो विदर्भः स्यात् ।

षट्कर्मकरणमेतज् ज्ञात्वाऽनुष्ठानमाचरेन्मन्त्री ॥ ३ ॥

‘आदौ नामनिवेशो दीपनम्’ मन्त्रस्यादौ यन्नामनिवेशनं तद् दीपनं स्यात् । ‘अन्ते च पल्लवो ज्ञेयः’ मन्त्रस्यान्ते यन्नामनिवेशनं स पल्लवो ‘ज्ञेयः’ ज्ञातव्यः । ‘तन्मध्यगतं सम्पुटं’ तन्मन्त्रमध्ये निवेशितं नाम सम्पुटमिति स्यात् । ‘अथादिमध्यान्तगो रोधः’ अथ—पश्चात् मन्त्रस्यादौ मध्ये अन्ते च यन्नामनिवेशनं स रोधः स्यात् । ‘ग्रथनं वर्णान्तरितम्’ मन्त्रस्याक्षरमेकं नामाक्षरमेकं एवं वर्णग्रथनं तद् ग्रथनमिति स्यात् । ‘द्व्यक्षरमध्यस्थितो विदर्भः स्यात्’ मन्त्रस्याक्षरद्वयं प्रति पश्चाद् यन्नामनिवेशः स विदर्भः स्यात् । ‘षट्कर्म-करणमेतज्’, एतच्च शान्त्यादिषट्कर्मक्रियाविधानं ‘ज्ञात्वा’ बुद्ध्वा अनुष्ठानं मन्त्रवादी आचरेत् ॥ २ ॥ ३ ॥

दिक्कालमुद्रासनपल्लवानां भेदं परिज्ञाय जपेत् स मन्त्री ।

न चान्यथा सिध्यति तस्य मन्त्रं कुर्वन् सदा तिष्ठतु जाप्यहोमम् ॥ ४ ॥

‘दिक्काल०’ इत्यादि । दिक् च कालश्च मुद्रा च आसनं च पल्लवश्च दिक्कालमुद्रासनपल्लवाः तेषां दिक्काल-मुद्रासनपल्लवानां, ‘भेदं’ विवरणं, ‘परिज्ञाय’ सम्यग् ज्ञात्वा, सः ‘मन्त्री’ मन्त्रवादी जपेत् ‘जापं’ कुर्यात् । ‘न चान्यथा सिध्यति तस्य मन्त्रम्’ अन्यथा—दिक्कालादिभेदपरिज्ञानाभावे तस्य—मन्त्रिणः मन्त्रं ‘न सिध्यति’ सिद्धिं न प्राप्नोति । ‘कुर्वन् सदा तिष्ठतु जाप्यहोमं’ जाप्यहोमं कुर्वन् सन् सदा तिष्ठतु परं न सिध्यति ॥ ४ ॥

वश्याकृष्टिस्तम्भननिषेधविद्वेषचलनशान्तिकं पुष्टिम् ।

कुर्यात् सोमयमामरहराभिमरुदब्धिनिर्ऋतिदिग्वदनः ॥ ५ ॥

‘वश्याकृष्टिस्तम्भननिषेधविद्वेषचलनशान्तिकं पुष्टिम्’ एतानि कर्माणि । ‘सोमयमामरहराभिमरुदब्धिनिर्ऋति-दिग्वदनः’ । ‘सोम’ उत्तराभिमुखेन वश्यकर्म । ‘यम’ दक्षिणाभिमुखेन ‘आकृष्टिः’ आकर्षणकर्म । ‘अमर’ पूर्वाभि-मुखेन स्तम्भनकर्म । ‘हर’ ईशानाभिमुखेन निषेधकर्म । ‘अभि’ अभिदिङ्मुखेन विद्वेषणकर्म । ‘मरुत्’ वायव्यदिङ्मुखेन ‘चलन’ उच्चाटनकर्म । ‘अब्धि’ पश्चिमाभिमुखेन ‘शान्तिकं’ शान्तिकर्म । ‘नैर्ऋतिदिग्वदनः’ नैर्ऋत्याभिमुखेन पौष्टिककर्म । इति दिग्वदनो भूत्वा वश्यादिकर्माणि कुर्यात् ॥ ५ ॥

पूर्वाह्णे वश्यकर्माणि मध्याह्णे प्रीतिनाशनम् ।

उच्चाटनं पराह्णे च सन्ध्यायां प्रतिषेधकृत् ॥ ६ ॥

शान्तिकर्मार्धरात्रे च प्रभाते पौष्टिकं तथा ।

वश्यं मुक्त्वाऽन्यकर्माणि सव्यहस्तेन योजयेत् ॥ ७ ॥

‘पूर्वाह्णे’ इत्यादि । पूर्वाह्नकाले वसन्तर्तौ वश्याकृष्टिस्तम्भनकर्माणि कुर्यात् । ‘मध्याह्णे प्रीतिनाशनम्’ मध्याह्नकाले प्रीष्मर्तौ विद्वेषणं कुर्यात् । ‘उच्चाटनं पराह्णे’ अपराह्णे वर्षर्तौ उच्चाटनं कुर्यात् । चः समुच्चये । ‘सन्ध्यायां प्रतिषेधकृत्’ सन्ध्याकाले शरदृती निषेधं कुर्यात् । ‘शान्तिकर्मार्धरात्रे च’ अर्धरात्रे हेमन्तर्तौ शान्तिकर्म कुर्यात् । चः समुच्चये । ‘प्रभाते पौष्टिकं तथा’ प्रभातसमये शिशिरर्तौ पौष्टिकं कर्म कुर्यात् । ‘वश्यं मुक्त्वा’ वश्यकर्म वर्जयित्वा । ‘अन्य-कर्माणि’ इतराकृष्टिकर्माणि ‘सव्यहस्तेन’ दक्षिणहस्तेन ‘योजयेत्’ कुर्यात्, वश्यकर्मैव वामहस्तेन योजयेदित्यर्थः ॥ ६ ॥ ७ ॥

इति कर्मकालनिरूपणम् ॥

अङ्कुश-सरोज-बोध-प्रवाल-सच्छङ्ख-वज्रमुद्राः स्युः ।

आकृष्टि-वश्य-शान्तिक-विद्वेषण-रोध-वधसमये ॥ ८ ॥

‘अङ्कुश’ अङ्कुशमुद्रा ‘आकृष्टि’ आकर्षणकर्मणि । ‘सरोज’ सरोजमुद्रा ‘वश्य’ वश्यकर्मणि । ‘बोध’ ज्ञानमुद्रा ‘शान्तिक’ शान्तिकपौष्टिकयोः । ‘प्रवाल’ पल्लवमुद्रा ‘विद्वेषणे’ फट्कर्मणि । ‘सच्छङ्ख’ सम्यक् शङ्खमुद्रा ‘रोध’ स्तम्भनकर्मणि । ‘वज्र’ वज्रमुद्रा ‘वधसमये’ प्रतिषेधसमये । इति षट्कर्मकरणे एता मुद्राः ‘स्युः’ भवेयुः ॥ ८ ॥

दण्डस्वस्तिकपङ्कजकुक्कुटकुलिशोच्चभद्रपीठानि ।

उदयार्करक्तशशधरधूमहरिद्रासिता वर्णाः ॥ ९ ॥

‘दण्ड’ दण्डासनं आकर्षणकर्मणि । ‘स्वस्तिक’ स्वस्तिकासनं वश्यकर्मणि । ‘पङ्कज’ पङ्कजासनं शान्तिकपौष्टिकयोः । ‘कुक्कुट’ कुक्कुटासनं विद्वेषोच्चाटनयोः । ‘कुलिश’ वज्रासनं स्तम्भनकर्मणि । ‘उच्चभद्रपीठानि’ विस्तीर्णभद्रपीठासनं निषेधकर्मणि । इत्येतान्यासनानि षट्कर्मकरणे योजनीयानि ॥

‘उदयार्क’ अरुणवर्ण आकृष्टिकर्मणि । ‘रक्त’ जपाकुसुमवर्णं वश्यकर्मणि । ‘शशधर’ चन्द्रकान्तवर्णं शान्तिकपौष्टिकयोः । ‘धूम’ धूमवर्णं विद्वेषणोच्चाटनयोः । ‘हरिद्रा’ पीतवर्णं स्तम्भनकर्मणि । ‘असित’ कृष्णवर्णं निषेधकर्मणि । इत्येवंविधा वर्णाः षट्कर्मकरणे प्रयोक्तव्याः । इत्यासनवर्णभेदाः कथिताः ॥ ९ ॥

विद्वेषणाकर्षणचालनेषु हुं वौषडन्तं फडिति प्रयोज्यम् ।

वश्ये वषड् वैरिवधे च धे धे स्वाहा स्वधा शान्तिकपौष्टिके च ॥ १० ॥

‘विद्वेषणेत्यादि’ विद्वेषणे हुं इति पल्लवं प्रयोज्यम् । आकर्षणे वौषडन्तं प्रयोज्यम् । उच्चाटने फडिति पल्लवं योज्यम् । वश्ये कर्मणि वषड् इति पल्लवं योज्यम् । वैरिवधे च घे घे इति पल्लवं योज्यम् । चशब्दात् स्तम्भने घेघे इति पल्लवं योज्यम् । ‘स्वाहा’ स्वाहेति पल्लवं शान्तिके योज्यम् । ‘स्वधा’ इति पल्लवं पौष्टिके योज्यम् । इति षट्कर्मकरणे एते पल्लवा योजनीयाः ॥१०॥

स्फटिकप्रवालमुक्ताफलचामीकरपुत्रजीवकृतमणिभिः ।

अष्टोत्तरशतजाप्यं शान्त्याद्यर्थे करोतु बुधः ॥ ११ ॥

स्फटिककृतमणिभिः शान्तिककर्मणि । प्रवालकृतमणिभिः वश्याकर्षणयोः । मुक्ताफलकृतैः पौष्टिककर्मणि । ‘चामीकर’ सुवर्णकृतमणिभिः स्तम्भनकर्मणि । पुत्रजीवकृतमणिभिः विद्वेषणोच्चाटनप्रतिषेधकर्मणि । एतेषां कृतमणिभिः ‘अष्टोत्तरशतजाप्यं’ अष्टाधिकशतं जाप्यं ‘शान्त्याद्यर्थे’ शान्तिकं आदि कृत्वा ‘बुधः’ प्राज्ञः ‘करोतु’ कुर्यात् ॥११॥

मोक्षाभिचारशान्तिकवश्याकर्षेषु योजयेत् क्रमशः ।

अङ्गुष्ठाद्यङ्गुलिका मणयोऽङ्गुष्ठेन चाल्यन्ते ॥ १२ ॥

‘अङ्गुष्ठाद्यङ्गुलिका’ अङ्गुष्ठमादि कृत्वा अङ्गुलीः मोक्षादिकर्मसु योजयेत् । कथम् ? ‘क्रमशः’ क्रमपरिपाठ्या । ‘मणयः’ प्राक्कथितमणयः ‘अङ्गुष्ठेन चाल्यन्ते’ मोक्षार्थी अङ्गुष्ठेन चालयेत् । अभिचारकर्मणि तर्जन्या, शान्तिकपौष्टिकयोः मध्यमाङ्गुल्या, वश्यकर्मणि अनामिकाङ्गुल्या, आकर्षणकर्मणि कनिष्ठाङ्गुल्या चालयेत् ॥१२॥

इति ग्रन्थानुसारेण दिक्कालादिभेदेन षट् कर्माणि व्याख्यातानि ॥

इदानीं देव्याराधनगृहयन्त्रोद्धारो विधीयते—

चतुरस्रं विस्तीर्णं रेखात्रयसंयुतं चतुर्द्वारम् ।

विलिखेत् सुरभिद्रव्यैर्यन्त्रमिदं हेमलेखन्या ॥ १३ ॥

‘चतुरस्रं’ समचतुरस्रम् । ‘विस्तीर्णं’ विपुलम् । ‘रेखात्रयसंयुतं’ रेखात्रितयसंयुक्तम् । ‘चतुर्द्वारं’ चतुर्द्वारान्वितम् । ‘विलिखेत्’ विशेषेण लिखेत् । ‘सुरभिद्रव्यैः’ कुङ्कुमकस्तूरिकादिसुगन्धिद्रव्यैः । ‘यन्त्रमिदं’ इदं देव्या गृहयन्त्रम् । ‘हेमलेखन्या’ स्वर्णलेखन्या ॥१३॥

धरणेन्द्राय नमोऽधच्छदनाय नमस्तथोर्ध्वच्छदनाय ।

पद्मच्छदनाय नमो मन्त्रान् वेदादिमायाद्यान् ॥ १४ ॥

धरणेन्द्राय नमः इति पूर्वद्वारपदम् । अधच्छदनाय नमः इति दक्षिणद्वारपदम् । ‘तथा’ तेन प्रकारेण । ऊर्ध्वच्छदनाय नमः इति पश्चिमद्वारपदम् । पद्मच्छदनाय नमः इति उत्तरद्वारपदम् । ‘मन्त्रानेतान्’ एतान् मन्त्रान् । कथम्भूतान् ? ‘वेदादिमायाद्यान्’ उकारादिर्होकाराद्यान् ॥१४॥

प्रविलिख्यैतान् क्रमशः पूर्वादिद्वारपीठरक्षार्थम् ।

दश दिक्पालान् विलिखेदिन्द्रादीन् प्रथमरेखान्ते ॥ १५ ॥

अस्मिन् श्लोके पूर्वार्धे पूर्वमेव सम्बन्धनीयम् । उत्तरार्धे उत्तरत्र सम्बन्धनीयम् । 'एतान्' प्राक्कथित-धरणेन्द्रादिद्वारपालमन्त्रान् 'प्रविलिख्य' प्रकषेण लिखित्वा 'क्रमशः' पूर्वदक्षिणपश्चिमोत्तरक्रमेण । किमर्थम् ? 'पूर्वादिद्वारपीठरक्षार्थम्' प्राच्यादिद्वारपीठरक्षार्थम् ।

ॐ ह्रीं घरणेन्द्राय नमः इति प्राच्यां दिशि, ॐ ह्रीं अधच्छदनाय नमः इति दक्षिणस्यां दिशि, ॐ ह्रीं ऊर्ध्वच्छदनाय नमः इति पश्चिमायां दिशि, ॐ ह्रीं पद्मच्छदनाय नमः इति उत्तरस्यां दिशि, इति चतुर्द्वारपीठेषु लिखेत् । अथोत्तरार्धव्याख्या—'दश दिक्पालान् विलिखेत्' दश लोकपालान् सम्यग्लिखेत् । किमादीन् ? 'इन्द्रादीन्' इन्द्रप्रभृतीन् । 'प्रथमरेखान्ते' प्राक्कथितरेखान्त्रयमध्ये आदिरेखान्ते ॥ १५ ॥

लरशषवयसहवर्णान् सविन्दुकानष्टदिक्पतिसमेतान् ।

प्रणवादिनमोऽन्तगतानाँहीमधोर्ध्वच्छदनसंज्ञे च ॥ १६ ॥

'लरशषवयसहवर्णान्' लश्च रश्च शश्च षश्च वश्च यश्च सश्च हश्च लरशषवयसहा; ते च ते वर्णाश्च लरशष-वयसहवर्णाः तान्, 'सविन्दुकान्' सह बिन्दुना वर्तन्ते इति सविन्दुकाः तान् । पुनरपि कथम्भूतान् ? 'अष्ट-दिक्पतिसमेतान्' अष्टलोकपालयुतान् । 'प्रणवादिनमोऽन्तगतान्' न केवलं लोकपालानेव, 'ॐहीमधोर्ध्वच्छदनसंज्ञे च' ॐ ह्रीं अधच्छदनाय नमः, ॐ ह्रीं ऊर्ध्वच्छदनाय नमः इति संज्ञे च ।

लोकपालस्थापनक्रमः—

ॐ लं१ इन्द्राय नमः इति प्राच्याम् । ॐ रं२ अग्नये नमः इत्याग्नेय्याम् । ॐ शं३ यमाय नमः इति दक्षिणस्यां दिशि, ॐ षं४ नैर्ऋत्याय नमः इति नैर्ऋत्यां दिशि । ॐ वं५ वरुणाय नमः इति पश्चिमायां दिशि । ॐ यं६ वायवे नमः इति वायव्यां दिशि, ॐ सं७ कुबेराय नमः इत्युत्तरस्यां दिशि । ॐ हं८ ईशानाय नमः इति ऐशान्यां दिशि । ॐ ह्रीं अधच्छदनाय नमः इत्यधः, ॐ ह्रीं ऊर्ध्वच्छदनाय नमः इत्यूर्ध्वे लिखेत्, एवं दशदिक्पालस्थापनक्रमः ॥ १६ ॥

दिक्षु विदिक्षु क्रमशो जयादि—जम्भादिदेवता विलिखेत् ।

प्रणवत्रिमूर्तिपूर्वा नमोऽन्तगा मध्यरेखान्ते ॥ १७ ॥

'दिक्षु विदिक्षु' दिशासु विदिशासु, 'क्रमशः' दिशाविदिशाक्रमेण 'जयादिजम्भादिदेवताः' चतुर्दिशि जयादिदेवताः चतुर्विदिक्षु च जम्भादिदेवताः, कथम्भूताः ? 'प्रणवत्रिमूर्तिपूर्वाः' ॐहीपूर्वाः, पुनरपि किम्भूताः ? 'नमोऽन्तगाः' नमःशब्दावसानाः, क ? 'मध्यरेखान्ते' प्राग्लिखितमध्यरेखान्ते विलिखेत् ॥ १७ ॥

१ लं लं इति ख पाठः

२ रं रं इति ख पाठः ।

३ शं शं ,,

४ षं षं ,,

५ वं वं ,,

६ यं यं ,,

७ सं सं ,,

८ हं हं ,,

आद्या जया च विजया तथाऽजिता चापराजिता देव्यः ।
जम्भामोहास्तम्भास्तम्भिन्यो देवता एताः ॥ १८ ॥

‘आद्या’ प्रथमा, ‘जया च’ जयानामा ‘विजया’ विजयानामा, ‘तथा’ तेन प्रकारेण, अजितानामा, ‘चः’ समुच्चये, ‘अपराजिता देव्यः’ अपराजितेति दिग्देव्यः । ‘जम्भा’ जम्भा नाम, ‘मोहा’ मोहा नाम, ‘स्तम्भा’ स्तम्भा नाम, ‘स्तम्भिनी’ स्तम्भिनीति विदिग्देवताः । एता अष्ट देव्यः ।

ॐ ह्रीं जये ! नमः इति प्राच्यां दिशि । ॐ ह्रीं विजये ! नमः इति दक्षिणस्यां दिशि । ॐ ह्रीं अजिते ! नमः इति पश्चिमायां दिशि । ॐ ह्रीं अपराजिते ! नमः इत्युत्तरस्यां दिशि । ॐ ह्रीं जम्भे ! नमः इत्याग्नेय्यां दिशि । ॐ ह्रीं मोहे ! नमः इति नैर्ऋत्यां दिशि । ॐ ह्रीं स्तम्भे ! नमः इति वायव्यां दिशि । ॐ ह्रीं स्तम्भिनि ! नमः इत्यैशान्यां दिशि लिखेत् । एवमष्टदेवीनां मध्यरेखास्थापनक्रमः ॥ १८ ॥

तन्मध्येऽष्टदलाम्भोजमनङ्गकमलाभिधाम् ।

विलिखेच्च पद्मगन्धां पद्मास्यां पद्ममालिकाम् ॥ १९ ॥

‘तन्मध्ये’ प्राग्लिखितरेखात्रयमण्डलमध्ये, ‘अष्टदलाम्भोजं’ अष्टदलकमलं, ‘अनङ्गकमलाभिधाम्’ तत्पत्रदले अनङ्गकमलानामां, ‘विलिखेच्च’ विशेषेण लिखेत्, ‘पद्मगन्धां’ पद्मगन्धानामाम्, ‘पद्मास्याम्’ पद्मास्यानामाम्, ‘पद्ममालिकाम्’ पद्ममालानामधेयाम् ॥ १९ ॥

मदनोन्मादिनीं पश्चात् कामोद्दीपनसंज्ञिकाम् ।

संलिखेत् पद्मवर्णाख्यां त्रैलोक्यक्षोभिणीं ततः ॥ २० ॥

‘मदनोन्मादिनीं’ मदनोन्मादिनीनामां, ‘पश्चात्’ तदनन्तरम्, ‘कामोद्दीपनसंज्ञिकाम्’ कामोद्दीपननाम्नीं ‘संलिखेत्’ सम्यग् लिखेत्, ‘पद्मवर्णाख्याम्’ पद्मवर्णानामधेयां, ‘त्रैलोक्यक्षोभिणीं ततः’ अनन्तरं त्रैलोक्यक्षोभिणीं लिखेत् ॥ २० ॥

तेजोह्रींकारपूर्वोक्ता नमःशब्दावसानगाः ।

अकारादिहकारान्तान् केशरेषु नियोजयेत् ॥ २१ ॥

अस्य श्लोकस्य पूर्वार्धं पूर्वमेव सम्बन्धनीयम्, उत्तरार्धं तूत्तरत्र । ‘तेजोह्रींकार’ उकारह्रींकार, ‘पूर्वोक्ताः’ पूर्वमुक्ता या दिशां अष्ट देव्यः ताः उह्रींकारपूर्वोक्ताः । किंविशिष्टाः ? ‘नमःशब्दावसानगाः’ नमःशब्दान्त्वगताः । आसामुद्धारः—ॐ ह्रीं अनङ्गकमलायै नमः, ॐ ह्रीं पद्मगन्धायै नमः, ॐ ह्रीं पद्मास्यायै नमः, ॐ ह्रीं पद्ममालायै नमः, ॐ ह्रीं मदनोन्मादिन्यै नमः, ॐ ह्रीं कामोद्दीपनायै नमः, ॐ ह्रीं पद्मवर्णायै नमः, ॐ ह्रीं त्रैलोक्यक्षोभिण्यै नमः इति प्राच्याद्यष्टदलेषु स्थापनीयाः । इदानीमपरार्धं कथ्यते—‘अकारादिहकारान्तान्’ अकारमार्दि कृत्वा हकारपर्यन्तान्, ‘केशरेषु’ कर्णिकाया मध्ये, ‘नियोजयेत्’ नियुक्तं कुर्यात् ॥ २१ ॥

इदानीं देव्याश्चक्रचतुष्टयस्थापनक्रमः—

भक्तियुतो भुवनेशश्चतुःकलायुतं कूटमथ देव्याः ।

वर्णचतुष्कनमोऽन्तं स्थाप्याः प्राच्यादिदिक्षु पद्मबहिः ॥ २२ ॥

‘भक्तियुतः’ उकारयुतः । कः ? ‘भुवनेशः’ ह्रींकारः । ‘चतुःकलायुतम्’ आ ई ऊ ऐ इति चतुःकलायुतम् । किं तत् ? ‘कूटम्’ क्षकारम् । ‘अथ’ अनन्तरम् । ‘देव्या वर्णचतुष्कम्’ पद्मावतीवर्णचतुष्टयम् । ‘नमोऽन्तम्’ नमः-शब्दान्तमत्र ‘स्थाप्याः’ स्थापनीयाः । कासु ? ‘प्राच्यादिदिक्षु’ पूर्वादिचतुर्दिशासु । क ? ‘पद्मबहिः’ अष्टदलकमलबहिःप्रदेशे ।

मन्त्रोद्धारः—ॐ ह्रीं क्षौं प नमः इति प्राच्यां दिशि, ॐ ह्रीं क्षीं घा नमः इति याम्यायाम्, ॐ ह्रीं क्षूं व नमः इति पश्चिमायाम्, ॐ ह्रीं क्षौं ती नमः इत्युत्तरस्यां विलिखेत् ॥ २२ ॥

एतत् पद्मावतीदेव्या भवेच्चक्रचतुष्टयम् ।

पञ्चोपचारतः पूजां नित्यमस्याः करोत्विति ॥ २३ ॥

‘एतत्’ कथितं, ‘पद्मावतीदेव्या भवेत् चक्रचतुष्टयम्’ पद्मावतीदेव्याः चक्रचतुष्टयं स्यात् । ‘पञ्चोपचारतः’ आह्वानादिपञ्चभेदैः, ‘पूजाम्’ अर्चनाम्, ‘नित्यम्’ सर्वकालं, ‘अस्याः’ पद्मावतीदेव्याः, ‘इति’ एवं अनेन प्रकारेण पूजां ‘करोतु’ कुर्यात् ॥ २३ ॥

आह्वानं स्थापनं देव्याः सन्निधीकरणं तथा ।

पूजां विसर्जनं प्राहुर्बुधाः पञ्चोपचारकम् ॥ २४ ॥

‘आह्वानम्’ देव्या आह्वानम्, ‘स्थापनम्’ देव्याः स्थापनम्, ‘सन्निधीकरणम्’ देव्याः सन्निधीकरणम्, ‘तथा’ तेन प्रकारेण, ‘पूजाम्’ देव्या अर्चनाम्, ‘विसर्जनम्’ देव्या विसर्जनम्, ‘बुधाः’ पण्डिताः, ‘पञ्चोपचारकम्’ एतत्पञ्चोपचारकं, ‘प्राहुः’ कथयन्ति ॥ २४ ॥

ॐ ह्रीं नमोऽस्तु भगवति ! पद्मावति ! एहि एहि सं वौषट् ।

कुर्यादमुना मन्त्रेणाह्वानमनुस्मरन् देवीम् ॥ २५ ॥

“ॐ ह्रीं नमोऽस्तु भगवति ! पद्मावति ! एहि एहि सं वौषट्” इति ‘अमुना मन्त्रेण’ अनेन मन्त्रेण, ‘अनुस्मरन्’ चिन्तयन्, ‘देवी’ पद्मावती, ‘आह्वानं’ देव्या आह्वानं कुर्यात् ॥ २५ ॥

तिष्ठद्वितयं ठान्तद्वयं च संयोजयेत् स्थितीकरणे ।

सन्निहिता भवशब्दं मम वषडिति सन्निधीकरणे ॥ २६ ॥

‘तिष्ठद्वितयं’ प्राक्कथितमन्त्राग्रे तिष्ठ तिष्ठ इति पदद्वयम्, ‘ठान्तद्वयम्’ ठः ठः इति ठकारद्वयं च ‘संयोजयेत्’ सम्यग् नियोजयेत्, क ? ‘स्थितीकरणे’ देव्याः स्थापने । ‘सन्निहिता भवशब्दं मम वषडिति’ प्राक्कथितमन्त्रस्याग्रे मम सन्निहिता भव भव वषट् इति पदं योज्यम् । क ? ‘सन्निधीकरणे’ देव्यर्चने उपकरणे ॥ २६ ॥

गन्धादीन् गृह्ण गृह्णेति नमः पूजाविधानके ।

स्वस्थानं गच्छ गच्छेति जस्त्रिः स्यात् तद्विसर्जने ॥ २७ ॥

‘गन्धादीन् गृह्ण गृह्णेति नमः’ इति ‘स्यात्’ प्राक्कथितमन्त्रस्याग्रे योज्यम् । क ? ‘पूजनविधानके’ देव्या अर्चनविधाने । ‘स्वस्थानं गच्छ गच्छेति जस्त्रिः स्यात्’ प्राक्कथितमन्त्रस्याग्रे स्वस्थानं गच्छ गच्छ जः जः जः इति त्रिवारं योजयेत् । क ? ‘तद्विसर्जने’ देव्या विसर्जने ॥ २७ ॥

मन्त्रोद्धारः—ॐ ह्रीं नमोऽस्तु भगवति ! पद्मावति ! एहि एहि सं वीषट् ॥ इति आह्वानम् ॥
 ॐ ह्रीं नमोऽस्तु भगवति ! पद्मावति ! तिष्ठ तिष्ठ ठः ठः ॥ इति स्थितीकरणम् ॥
 ॐ ह्रीं नमोऽस्तु भगवति ! पद्मावति ! मम सन्निहिता भव भव वषट् ॥ इति सन्निधीकरणम् ॥
 ॐ ह्रीं नमोऽस्तु भगवति ! पद्मावति ! गन्धादीन् गृह्ण गृह्ण नमः ॥ इति पूजाविधानम् ॥
 ॐ ह्रीं नमोऽस्तु भगवति ! पद्मावति ! स्वस्थानं गच्छ गच्छ जः जः जः ॥ इति विसर्जनम् ॥

॥ एवं पञ्चोपचारक्रमः ॥

पूरकरेचकयोगादाह्वानविसर्जनं करोतु बुधः ।

पूजाभिमुखीकरण—स्थापनकर्माणि कुम्भकतः ॥ २८ ॥

‘पूरकरेचकयोगादाह्वानविसर्जनं करोतु बुधः’ पूरकयोगाद् ‘बुधः’ प्राज्ञः देव्या आह्वानं करोतु । रेचक-योगाद् देव्या विसर्जनं कुर्यात् । ‘पूजाभिमुखीकरण—स्थापनकर्माणि कुम्भकतः’ पूजासन्निधीकरणस्थापनकर्माणि कुम्भकयोगेन कुर्यात् ॥ २८ ॥

ब्रह्मादि लोकनाथं ह्रौंकारं व्योम षान्तमदनोपेतम् ।

पद्मे च पद्मकटिनि ! नमोऽन्तगो मूलमन्त्रोऽयम् ॥ २९ ॥

‘ब्रह्मादि’ उँकारादि, ‘लोकनाथं’ ह्रौंकारम्, ‘ह्रौंकारम्’ हैमिति बीजम्, ‘व्योम’ हकारः, कथम्भूतः ? ‘षान्त-मदनोपेतः’ षकारस्यान्तः सकारः मदनः क्लींकारः ताभ्यां युतः षान्तमदनोपेतः । कथम् ? ह्रस्वली इति । ‘पद्मे’ ! इति पदम्, चः समुच्चये ‘पद्मकटिनि !’ पद्मकटिनीति पदम्, ‘नमोऽन्तगः’ अन्ते नमः इति पदम् । ‘मूलमन्त्रोऽयम्’ अयं मन्त्रः पद्मावतीदेव्या मूलमन्त्रो ज्ञातव्यः ॥ २९ ॥

मन्त्रोद्धारः—ॐ ह्रीं ह्रौं ह्रस्वलीं पद्मे ! पद्मकटिनि ! नमः ॥

सिध्यति पद्मादेवी त्रिलक्षजाप्येन पद्मपुष्पाणाम् ।

अथवाऽरुणकरवीरकसवृन्तपुष्पप्रजाप्येन ॥ ३० ॥

‘सिध्यति’ सिद्धा भवति, का ? ‘पद्मादेवी’ पद्मावती देवी, केन ? ‘त्रिलक्षजाप्येन’ लक्षत्रयजाप्येन, केषाम् ? ‘पद्मपुष्पाणाम्’ सहस्रपत्रपुष्पाणाम्, अथवा तेषामभावे ‘अरुणकरवीरकसवृन्तपुष्पप्रजाप्येन’ रक्तकरवीरकवृन्तान्वित-प्रसूनजाप्येन सिद्धा भवति ॥ ३० ॥

ब्रह्म माया च ह्रौंकारं व्योम क्लींकारमूर्धगम् ।

श्रीं च पद्मे ! नमो मन्त्रं प्राहुर्विद्यां षडक्षरीम् ॥ ३१ ॥

‘ब्रह्म’ उकारः, ‘माया’ ह्रौंकारः, ‘चः’ समुच्चये, ‘ह्रौंकारं’ ह्रौमिति बीजम्, ‘व्योम’ हकारः, कथम्भूतं व्योम ? ‘क्लींकारमूर्धगम्’ क्लींकारोपरिस्थितम्, एवं ह्रस्वलीमिति, ‘श्रीं च’ श्रीमिति बीजं च, ‘पद्मे’ पद्मे ! इति पदम्, ‘नमः’ नमः इति पदम्, ‘मन्त्रं’ इमं कथितं मन्त्रम्, ‘विद्या षडक्षरीम्’ षडक्षरीमिति विद्यां ‘प्राहुः’ प्रकर्षेण आहुः।

मन्त्रोद्धारः—उँ ह्रौं ह्रस्वलीं श्रीं पद्मे ! नमः ॥ इति षडक्षरमन्त्रः ॥ ३१ ॥

वाग्भवं चित्तनाथं च ह्रौंकारं षान्तमूर्धगम् ।

बिन्दुद्वययुतं प्राहुर्विबुधारुयक्षरीमिमाम् ॥ ३२ ॥

‘वाग्भवं’ ऐकारम्, ‘चित्तनाथं’ क्लींकारम्, ‘चः’ समुच्चये, ‘ह्रौंकारं’ ह्रौमिति अक्षरम्, कथम्भूतम् ? ‘षान्तमूर्धगम्’ षकारस्यान्तः सकारः तस्य मूर्धगं सकारोपरिस्थितम्, ‘बिन्दुद्वययुतम्’ विसर्गसंयुतम्, एवं ह्रसौः इति बीजम्, ‘त्र्यक्षरीमिमाम्’ इमां त्र्यक्षरीविद्यां, ‘विबुधाः’ प्राज्ञाः, ‘प्राहुः’ प्रकर्षेण आहुः ॥ ३२ ॥

मन्त्रोद्धारः—उँ ऐ क्लीं ह्रसौः नमः ॥ इति त्र्यक्षरमन्त्रः ॥

वर्णान्तः पार्श्वजिनो यो रेफस्तलगतः स धरणेन्द्रः ।

तुर्यस्वरः सविन्दुः स भवेत् पद्मावतीसंज्ञः ॥ ३३ ॥

‘वर्णान्तः’ हकारः, स हकारः ‘पार्श्वजिनः’ पार्श्वजिनसंज्ञो भवति । ‘यो रेफः तलगतः’ यस्तलगतो रेफः ‘स धरणेन्द्रः’ धरणेन्द्रसंज्ञो भवति । ‘तुर्यस्वरः’ चतुर्थस्वरः—ईकारः, ‘सविन्दुः’ अनुस्वारयुतः ‘स भवेत् पद्मावतीसंज्ञः’ स पद्मावतीदेवीसंज्ञो भवति । एवं ह्रौं इत्येकाक्षरी विद्या ॥ ३३ ॥

त्रिभुवनजनमोहकरी विद्येयं प्रणवपूर्वनमनान्ता ।

एकाक्षरीति संज्ञा जपतः फलदायिनी नित्यम् ॥ ३४ ॥

‘त्रिभुवनजनमोहकरी’ त्रैलोक्यजनमोहकरी भवति ‘विद्येयम्’ इयं कथिता विद्या । कथम्भूता ? ‘प्रणव-पूर्वनमनान्ता’ उकारपूर्वनमःशब्दान्ता । किंनामा ? ‘एकाक्षरीतिसंज्ञा’ एकाक्षरीनामधेया । ‘जपतः फलदायिनी नित्यम्’ सर्वकालं जाप्यं कुर्वतः फलदायिनी भवति ॥ ३४ ॥

मन्त्रः—उँ ह्रौं नमः इत्येकाक्षरी ॥

इदानीं होमक्रमं कथ्यते—

तत्त्वावृतं नाम विलिख्य पत्रे तद्धोमकुण्डे निखनेत् त्रिकोणे ।

स्मरेषुभिः पञ्चभिराभिवेष्ट्य बाह्ये पुनर्लोकपतिप्रवेष्ट्यम् ॥ ३५ ॥



पद्मावती

Goddess Padmavati

पद्मावतीदेवी कमलवर्णा कुंकुटवाहना चतुर्भुजा पद्म-
पाशान्वितदक्षिणकरा फलाङ्गुशाधिष्ठितवासकरा चेति ।



पार्श्व

Yaksha Parshva

पार्श्वक्षं गजमुखं उरगच्छामण्डितशिरमं श्यामवर्णं कूर्मवाहन
चतुर्भुजं बीजप्रकोरगयुतदक्षिणपाणिं नकुलकाहियुतवासपाणिं चेति ।

‘तत्त्वावृतम्’ ह्रींकारवेष्टितम् । किं तत् ? ‘नाम’ देवदत्तनाम । ‘विलिख्य’ लिखित्वा । क्व? ‘पत्रे’ ताम्रपत्रे । किं कृत्वा ? ‘स्मरेषुभिः’ कामबाणैः । कतिसङ्ख्यैः ? ‘पञ्चभिः’ । एवं द्रौं द्रौं क्लीं ब्लूं सः एतैः । ‘आऽभिवेष्टय’ आ समन्ताद् वेष्टयित्वा । ‘पुनः’ पुनरपि । ‘बाह्ये’ नामबाह्ये । ‘लोकपतिप्रवेष्टयम्’ ह्रींकारवेष्टितं कृत्वा । ‘तद्दोमकुण्डे’ तत् ताम्रपत्रयन्त्रं होमकुण्डमध्ये । कथंभूते ? ‘त्रिकोणे’ श्यन्ने । ‘निखनेत्’ पूरयेत् ॥

मधुरत्रिकसम्मिश्रितगुग्गुलकृतचणकमात्रवटिकानाम् ।
त्रिंशत्सहस्रहोमात् सिध्यति पद्मावती देवी ॥ ३६ ॥

‘मधुरत्रिकसम्मिश्रित’ – धृतदुग्धशर्करासंयुक्त – ‘गुग्गुलकृत’ – यक्षधूपकृत – ‘चणकमात्रवटिकानाम्’ । ‘त्रिंशत्सहस्रहोमात्’ त्रिंशत्सहस्रसङ्ख्यवटिकानां हवनात् । ‘सिध्यति’ सिद्धा भवति । का ? ‘पद्मावती देवी’ फणिशेखरा देवी ॥

मन्त्रस्यान्ते नमःशब्दं देवताराधनाविधौ ।
तदन्ते होमकाले तु स्वाहाशब्दं नियोजयेत् ॥ ३७ ॥

‘मन्त्रस्यान्ते’ मन्त्रपरिसमाप्तौ । ‘नमःशब्दं’ नमः इति वाक्यम् । क्व ? ‘देवताराधनाविधौ’ देव्या मन्त्राराधनविधाने संयोजयेत् । ‘तु’ पुनः । ‘तदन्ते’ मन्त्राराधनान्ते । ‘होमकाले’ हवनसमये । ‘स्वाहाशब्दं’ स्वाहेतिशब्दम् । ‘नियोजयेत्’ संयोजयेत् ॥

दशलक्षजाप्यहोमात् प्रत्यक्षो भवति पार्श्वयक्षोऽसौ ।
न्यग्रोधमूलवासी श्यामाङ्गस्त्रिनयनो नूनम् ॥ ३८ ॥

‘दशलक्षजाप्यहोमात्’ दशलक्षजाप्यहवनात् । ‘प्रत्यक्षो भवति’ साक्षात् प्रत्यक्षो भवति । कः ? ‘पार्श्वयक्षोऽसौ’ असौ पार्श्वनामधेयो यक्षः । कथंभूतः ? ‘न्यग्रोधमूलवासी’ वटशृङ्गमूलवासी । किंविशिष्टः ? ‘श्यामाङ्गः’ । पुनः कथंभूतः ? ‘त्रिनयनः’ त्रिनेत्रः । ‘नूनं’ निश्चितम् ॥ मन्त्रः—ॐ ह्रीं पार्श्वयक्ष! दिव्य-
रूप महर्षण एहि एहि ॐ क्रौं ह्रीं नमः ॥ यक्षाराधनविधानमन्त्रोऽयम् ॥

निजसैन्यैर्मायामयसमुच्छ्रितैर्वैरिलोकमग्रस्थम् ।
विमुखीकरोति यक्षः सङ्ग्रामे निमिषमात्रेण ॥ ३९ ॥

‘निजसैन्यैः’ स्वकीयसैन्यैः । कथंभूतैः ? ‘मायामयसमुच्छ्रितैः’ ह्रींकारकृतप्राकारसम्यगुच्छ्रितैः । ‘वैरिलोकम्’ शत्रुसेनासमूहम् । कथंभूतम् ? ‘अग्रस्थम्’ स्वकीयसैन्यपुरःस्थितम् । ‘विमुखीकरोति’ पराङ्मुखी-
करोति । कोऽसौ ? ‘यक्षः’ पार्श्वयक्षः । क्व ? ‘सङ्ग्रामे’ रणाङ्गणभूमौ । कथम् ? ‘निमिषमात्रेण’ क्षणमात्रेण ॥

सान्तं बिन्दूर्ध्वरेफं बहिरपि विलिखेदायताष्टाब्जपत्रं

दिक्ष्वै श्रीं ह्रीं स्मरेशो गजवशकरणं ह्रौं तथा क्लैं पुनर्युं ।

बाह्ये ह्रीमौ नमोऽर्हं दिशि लिखितचतुर्बीजकं होमयुक्तं

मुक्तिश्रीवल्लभोऽसौ भुवनमपि वशं जायते पूजयेद् यः ॥ ४० ॥

‘सान्तम्’ सकारस्यान्तं हकारम् । कथंभूतम् ? ‘बिन्दूर्ध्वरेफम्’ अनुस्वास्-ऊर्ध्वरेफान्वितम् । एवं ह्रौं इति बीजं विलिखेत् । ‘बहिरपि’ ह्रमक्षरबहिःप्रदेशे । ‘विलिखेत्’ विशेषेण लिखेत् । किम् ? ‘आयताष्टाब्ज-पत्रम्’ विस्तीर्णाष्टाभोजपत्रम् । ‘दिक्षु’ तत्पत्रप्राच्यादिचतुर्दिशासु । ‘ऐं श्रीं ह्रीं स्मरेशः’ पूर्वदले ऐं इति, दक्षिणदले श्रीं इति, पश्चिमदले ह्रीं इति, उत्तरदले क्लौं इति एवं लिखेत् । ‘गजवशकरणं ह्रौं तथा क्लैं पुनर्युं’ इतरविदिक्चतुर्दलेषु द्विपवशकरणं आग्नेयदले क्लौं इति, नैऋत्यदले ह्रौं इति । ‘तथा’ तेन प्रकारेण वायव्यदले क्लैं इति । ‘पुनर्युं’ पश्चादीशानदले युं इति लिखेत् । ‘बाह्ये ह्रीं’ तद्यन्त्रबहिः ह्रींकारेण वेष्टयेत् । ‘ॐ नमोऽर्हं दिशि लिखितचतुर्बीजकम्’ ॐ नमोऽर्हमिति पदं प्राच्यादिचतुर्दिशासु लिखितं ऐं श्रीं ह्रीं क्लौं इति चत्वारि बीजानि । ‘होमयुक्तं’ स्वाहाशब्दयुतम् । एवं ॐ नमोऽर्हं ऐं श्रीं ह्रीं क्लौं स्वाहेति मन्त्रः । ‘मुक्तिश्रीवल्लभोऽसौ भुवनमपि वशं जायते पूजयेद् यः’ एतच्चिन्तामणिनामयन्त्रं यः पूजयेद्, असौ पुमान् मुक्त्यङ्गनाप्रियो भवति । ‘भुवनपि’ लोकोऽपि । ‘वशं जायते’ वशीभवति ॥

इत्युभयभाषाकविशेखरश्रीमल्लिषेणसूरिविरचिते

भैरवपद्मावतीकल्पे देव्याराधनविधिर्नाम

तृतीयः परिच्छेदः ॥ ३ ॥

चतुर्थो द्वादशरञ्जिकामन्त्रोद्धारपरिच्छेदः ।

द्वादशपत्राम्बुरुहं मलवरयुंकारसंयुतं कूटम् ।

तन्मध्ये नामयुतं विलिखेत् क्लींकारसंरुद्धम् ॥ १ ॥

‘द्वादशपत्राम्बुरुहं’ द्वादशपत्रान्वितं पद्मम् । कथम्भूतम् ? ‘मलवरयुंकारसंयुतम्’ मथ लथ वथ रथ युंकारश्च मलवरयुंकाराः तैः संयुतम् । किम् ? ‘कूटम्’ क्षकारम् । एवं इम्बु इति । ‘तन्मध्ये नामयुतम्’ इम्बुमध्ये देवदत्तनामयुतम् । ‘विलिखेत्’ विशेषेण लिखेत् । कथम्भूतम् ? ‘क्लींकारसंरुद्धम्’ तत्पिण्डोभयपार्श्वे क्लीं-कारनिरुद्धं लिखेत् ॥

विलिखेज्जयादिदेवीः स्वाहान्तौकारपूर्विका दिक्षु ।

ज्ञभमहपिण्डोपेता विदिक्षु जम्भादिकास्तद्वत् ॥ २ ॥

‘विलिखेज्जयादिदेवीः’ जयादिचतुर्देवता विलिखेत् । कः ? ‘दिक्षु’ चतुर्दिशासु । ‘स्वाहान्तौकारपूर्विकाः’ ॐ जये ! स्वाहा इति पूर्वदले, ॐ विजये ! स्वाहा इति दक्षिणदले, ॐ अजिते ! स्वाहा इति पश्चिमदले, ॐ अपराजिते ! स्वाहा इत्युत्तरदले विलिखेत् । ‘ज्ञभमहपिण्डोपेताः’ ज्ञश्च भश्च मश्च हश्च ज्ञभमहाः ते च ते पिण्डास्तरूपेताः ज्ञभमहपिण्डोपेताः । कः ? ‘विदिक्षु’ विदिशासु । काः ? ‘जम्भादिकाः’ जम्भादीः चतुर्देवीः । ‘तद्वत्’ यथापूर्वं स्वाहान्तौकारपूर्विकाः । ॐ इम्बु जम्भे ! स्वाहा इत्याग्नेय्यां दिशि, ॐ इम्बु मोहे ! स्वाहा इति नैऋत्यदले, ॐ इम्बु स्तम्भे ! स्वाहा इति वायव्यदले, ॐ इम्बु स्तम्भिनि ! स्वाहा इति ईशानदले लिखेत् ॥

उद्धरितदलेषु ततो मकरध्वजबीजमालिखेच्चतुर्षु ।

गजवशकरणनिरुद्धं कुर्यात् त्रिर्मायया वेष्टयम् ॥ ३ ॥

‘उद्धरितदलेषु ततः’ तस्मादष्टपत्रलेखनानन्तरं उद्धरितदलेषु । कतिसंख्योपेतेषु ? ‘चतुर्षु’ चतुःसंख्येषु । ‘मकरध्वजबीजमालिखेत्’ क्लींकारबीजमालिखेत् । ‘गजवशकरणनिरुद्धं’ क्लींकारनिरुद्धम् । ‘त्रिर्मायया वेष्टयम्’ पत्रबाह्ये ह्रींकारेण त्रिधा वेष्टितम् । ‘कुर्यात्’ करोतु ॥

भूर्ये सुरभिद्रव्यैर्विलिख्य परिवेष्टय रक्तसूत्रेण ।

निक्षिप्य सुल्वभाण्डे मधुपूर्णे मोहयत्यबलाम् ॥ ४ ॥

‘भूर्ये’ भूर्यपत्रे । ‘सुरभिद्रव्यैः’ कुङ्कुमादिसुगन्धद्रव्यैः । ‘विलिख्य’ एतद् मन्त्रं लिखित्वा । ‘परिवेष्टय रक्तसूत्रेण’ रक्तसूत्रेण वेष्टयित्वा । ‘निक्षिप्य’ संस्थाप्य । कः ? ‘सुल्वभाण्डे’ अपक्वभाण्डे । कथम्भूते ? ‘मधुपूर्णे’ माक्षिकपूर्णे । ‘मोहयत्यबलाम्’ अबला वनिता तां मोहयति ॥

अस्य मूलमन्त्रोद्धारः—

१. कनक इति ख पाठः

उ क्ष्म्व्यू क्लीं जये ! विजये ! अजिते ! अपराजिते ! इक्ष्म्व्यू जम्भे ! भ्म्व्यू मोहे ! म्म्व्यू
स्तम्भे ! इक्ष्म्व्यू स्तम्भिनि ! क्लीं ह्रीं क्रौं वषट् ॥ मोहनविधौ क्लींरञ्जिकायन्त्रम् ॥

स्त्रीकपाले लिखेद् यन्त्रं क्लींस्थाने भुवनाधिपम् ।

त्रिसन्ध्यं तापयेद् रामाकृष्टिः स्यात् खदिराग्निना ॥ ५ ॥

‘स्त्रीकपाले’ वनिताकपाले । ‘लिखेद् यन्त्रं’ प्राक्कथितयन्त्रं लिखेत् । ‘क्लींस्थाने’ क्लींकारस्थाने । कम् ?
‘भुवनाधिपम्’ ह्रींकारं लिखेत् । ‘त्रिसन्ध्यम्’ त्रिकालम् । ‘तापयेत्’ तापनं कुर्यात् । ‘रामाकृष्टिः स्यात्’
वनिताकर्षणं भवेत् । केन ? ‘खदिराग्निना’ खदिरकाष्ठाग्निना । ह्याकर्षणे ह्रींरञ्जिकायन्त्रम् ॥

मायास्थाने च हुंकारं विलिखेन्नरचर्मणि ।

तापयेत् क्ष्वेडरक्ताभ्यां पक्षाहात् प्रतिषेधकृत् ॥ ६ ॥

‘मायास्थाने’ । ह्रींकारस्थाने । ‘चः’ समुच्चये । कम् ? ‘हुंकारम्’ हुं इति बीजम् । ‘विलिखेत्’ लिखेत् ।
क्व ? ‘नरचर्मणि’ मनुष्यचर्मणि लिखेत् । काभ्याम् ? ‘क्ष्वेडरक्ताभ्याम्’ विषगर्दभरुधिराभ्याम् । ‘तापयेत्’ पूर्ववत्
तापयेत् । ‘पक्षाहात्’ पक्षमध्ये । ‘प्रतिषेधकृत्’ प्रतिषेधकारि भवति ॥ प्रतिषेधकर्मणि हुंरञ्जिकायन्त्रम् ॥

हुंस्थाने मान्तमालिख्य सरेफं नामसंयुतम् ।

बिभीतफलके यन्त्रं द्वयोरपि च मर्त्ययोः ॥ ७ ॥

‘हुंस्थाने’ प्राङ्निषिद्धकर्मणि लिखितहुंकारस्थाने । ‘मान्तं’ यकारम् । ‘आलिख्य’ लेखयित्वा । कथम्भूतम् ।
‘सरेफम्’ ऊर्ध्वरेफान्वितम् । ‘नामसंयुतम्’ नामयुक्तम् । कयोः ? ‘द्वयोरपि च मर्त्ययोः’ अपि निश्चयेन । क्व ?
‘बिभीतफलके’ कलितरुफलके । ‘यन्त्रं’ एतद् यन्त्रं लेखनीयम् ॥

वाजिमाहिषकेशैश्च विपरीतमुखस्थयोः ।

आवेष्टय्य स्थापयेद् भूम्यां विद्वेषं कुरुते तयोः ॥ ८ ॥

‘वाजिमाहिषकेशैश्च’ अश्वमहिषकेशैः । चः समुच्चये । ‘आवेष्टय्य’ केशैः आ समन्ताद् वेष्टयित्वा । ‘विपरीत-
मुखस्थयोः’ अधोमुखस्थयोः । ‘स्थापयेत्’ निक्षिपेत् । क्व ? ‘भूम्याम्’ प्रेतवनभूम्याम् । ‘विद्वेषं कुरुते तयोः’
द्वयोर्मर्त्ययोः विद्वेषणं करोति ॥ विद्वेषणकर्मणि यंरञ्जिकायन्त्रम् ॥

पूर्वोक्ताक्षरसंस्थाने लेखिन्या काकपक्षया ।

मान्तं विसर्गसंयुक्तं प्रेताङ्गारविषारुणैः ॥ ९ ॥

घृकारिविष्ठासंयुक्तैः ध्वजयन्त्रं सनामकम् ।

लिखित्वोपरि वृक्षाणां बद्धमुच्चाटनं रिपोः ॥ १० ॥

‘पूर्वोक्ताक्षरसंस्थाने’ विद्वेषकर्मलिखित-र्य-इत्यक्षरस्थाने । ‘मान्तं’ यकारम् । कथम्भूतम् ? ‘विसर्गसंयुक्तम्’ बिन्दुद्वययुतं लिखेत् । कया ? ‘काकपक्षया लेखिन्या’ काकपक्षजनितलेखिन्या । कैः ? ‘प्रेताङ्गारविषारुणैः’ स्मशानाङ्गारविषकाकरक्तैः । कथम्भूतैः ? ‘घूकारिविष्ठासंयुक्तैः’ घूकारिः काकः, तस्य विष्ठा घूकारिविष्ठा तथा संयुक्तैः । ‘ध्वजयन्त्रं’ सूतीकर्पटं ध्वजयन्त्रं एतदुच्चाटनयन्त्रम् । कथम्भूतम् ? ‘सनामकम्’ देवदत्तनामान्वितम् । ‘लिखित्वा’ विलिख्य । ‘उपरि’ अग्रे । केषाम् ? ‘वृक्षाणां’ कलितरूपाम् । ‘बद्धं’ निबद्धम् । ‘रिपोः’ शत्रोः । ‘उच्चाटनं’ उच्चाटनं स्यात् ॥ उच्चाटनकर्मकरणे यः-रञ्जिकायन्त्रम् ॥

शृङ्गीगरलरक्ताभ्यां नृकपालपुटे लिखेत् ।

प्रेतास्थिजातलेखिन्या यःस्थाने तु नभोऽक्षरम् ॥ ११ ॥

‘शृङ्गीगरलरक्ताभ्यां’ शृङ्गीविषरासभरक्ताभ्याम् । ‘नृकपालपुटे लिखेत्’ मनुष्यकपालसम्पुटे लिखेत् । कया ? ‘प्रेतास्थिजातलेखिन्या’ शबास्थिजनितलेखिन्या । ‘यःस्थाने’ पूर्वलिखितफड्यकारस्थाने । ‘तु’ पुनः । किम् ? ‘नभोऽक्षरम्’ हकारं लिखेत् ॥

श्मशाने निखनेद् रोषात् कृत्वा तद् भस्मपूरितम् ।

करोति तत्कुलोच्चाटं वैरिणां सप्तरात्रतः ॥ १२ ॥

‘श्मशाने’ प्रेतवने । ‘निक्षिपेत्’ स्थापयेत् । कथम् ? ‘रोषात्’ । ‘कृत्वा तद् भस्मपूरितं’ तत् कपालसम्पुटे श्मशानभस्मपूरितं कृत्वा । ‘तद्’ । ‘वैरिणां’ शत्रूणाम् । ‘कुलोच्चाटं करोति’ कुलोच्चाटनं करोति । कथम् ? ‘सप्तरात्रतः’ ॥ उच्चाटनकर्मणि हरञ्जिकायन्त्रम् ॥

फडक्षरं नभःस्थाने श्मशानस्थितकर्पटे ।

निम्बार्कजरसेनैतद् विलिखेत् क्रुद्धचेतसा ॥ १३ ॥

‘फडक्षरं’ फडित्यक्षरम् । ‘नभःस्थाने’ प्राग्लिखितफडहकारस्थाने । ‘श्मशानस्थितकर्पटे’ श्मशानगृहीतवसने । ‘निम्बार्कजरसेन’ निम्बरविरसेन । ‘एतत्’ फडक्षरान्वितं यन्त्रं ‘विलिखेत्’ लिखेत् । कथम् ? ‘क्रुद्धचेतसा’ क्रुद्धभावेन ॥

श्मशाने निक्षिपेद् यन्त्रं यावत् तद् भुवि तिष्ठति ।

परिभ्राम्यत्यसौ तावद् वैरी काक इव क्षितौ ॥ १४ ॥

‘श्मशाने’ श्मशानभूमौ । ‘निक्षिपेत्’ । किम् ? ‘यन्त्रम्’ । ‘यावत् तद् भुवि तिष्ठति’ यावत्कालं तद् यन्त्रं भूम्यां तिष्ठति । ‘परिभ्राम्यत्यसौ तावद् वैरी काक इव’ असौ वैरी तावत्कालं काक इव भ्रमणं करोति । क्व ? ‘क्षितौ’ पृथिव्याम् ॥ उच्चाटनकर्मकरणे फडरञ्जिकायन्त्रम् ॥

फटस्थाने लिखेद् भान्तं भूर्ये तन्नामसंयुतम् ।

विषोपयुक्तरक्तेन नीलसूत्रेण वेष्टितम् ॥ १५ ॥

‘फटस्थाने’ प्राग्लिखितफडक्षरस्थाने । ‘लिखेत्’ विलिखेत् । ‘भान्तं’ मकारम् । ‘भूर्ये’ भूर्यपत्रे । कथम् ? ‘तन्नामसंयुतम्’ देवदत्तनामान्वितम् । केन ? ‘विषोपयुक्तरक्तेन’ शृङ्गीविषान्वितखररक्तेन । पुनः कथम्भूतम् ? ‘नीलसूत्रेण वेष्टितम्’ ॥

मृत्युत्रिकोदरे स्थाप्यं तच्च श्मशाने निवेशयेत् ।

सप्ताहाजायते शत्रोश्छेदभेदादिनिग्रहः ॥ १६ ॥

‘मृत्युत्रिकोदरे स्थाप्यं’ एतद् यन्त्रं श्मशानदग्धमृत्तिकाकृतपुत्तलिकोदरमध्ये स्थाप्यम् । स्थापयित्वा ‘तच्चश्मशाने निवेशयेत्’ तद् मृत्युत्रिकोदरे स्थापितयन्त्रं प्रेतवने स्थापयेत् । ‘सप्ताहात्’ सप्तदिनमध्ये । ‘जायते’ भवेत् । किं भवेत् ? ‘छेदभेदादिनिग्रहः’ छेदनभेदनादिनिग्रहणं भवेत् । कस्य ? ‘शत्रोः’ रिपोः ॥ रिपुच्छेदन-भेदननिग्रहकरणे मरञ्जिकायन्त्रम् ॥

तुर्यस्वरं लिखेद् विद्वान् मस्थाने नामसंयुतम् ।

कुङ्कुमागरुकर्पूरैर्भूर्यै रोचनयाऽन्वितैः ॥ १७ ॥

‘तुर्यस्वरं’ चतुर्थस्वरं ईकारम् । ‘लिखेत्’ विलिखेत् । क्व ? ‘मस्थाने’ फण्मकारस्थाने । कोऽसौ ? ‘विद्वान्’ । कथम् ? ‘नामसंयुतम्’ देवदत्तनामान्वितम् । कैः कृत्वा ? ‘कुङ्कुमागरुकर्पूरैः’ काश्मीरागरुचन्दनैः । कथम्भूतैः ? ‘रोचनयाऽन्वितैः’ गोररोचनायुक्तैः, क्व ? ‘भूर्यै’ भूर्यपत्रे ॥

सुवर्णमठितं कृत्वा बाहौ वा धारयेद् गले ।

करोतीदं सदा यन्त्रं तरुणीजनमोहनम् ॥ १८ ॥

‘सुवर्णमठितं कृत्वा’ सुवर्णेन वेष्टितं कृत्वा । ‘बाहौ वा’ दक्षिणभुजे वा । ‘धारयेद् गले’ कण्ठे वा धारयेत् । ‘करोतीदं’ एतत् करोति । ‘सदा’ सर्वकालम् । ‘यन्त्रं’ एतत्कथितयन्त्रम् । ‘तरुणीजनमोहनम्’ अबलाजनमोहकारि भवति ॥ वश्यकर्मकरणे ईरञ्जिकायन्त्रम् ॥

वषड्वर्णयुतं कूटं लिखेदीकारधामनि ।

भूर्यपत्रे सितेऽत्यन्ते रोचनाकुङ्कुमादिभिः ॥ १९ ॥

‘वषड्वर्णयुतं’ वषडित्यक्षरान्वितम् । कम् ? ‘कूटम्’ क्षकारं ‘लिखेत्’ । कस्मिन् स्थाने ? ‘ईकारधामनि’ फड्डीकारस्थाने । क्व ? ‘भूर्यपत्रे’ । कथम्भूते ? ‘सितेऽत्यन्ते’ अत्यन्तशुभ्रे । कैः ? ‘रोचनाकुङ्कुमादिभिः’ गोररोचनाकाश्मीरादिभिः ॥

त्रिलोहवेष्टितं कृत्वा बाहौ कण्ठे च धारयेत् ।

स्त्रीसौभाग्यकरं यन्त्रं स्त्रीणां चेतोऽभिरञ्जकम् ॥ २० ॥

‘त्रिलोहवेष्टितं कृत्वा बाहौ कण्ठे च धारयेत्’ ताम्रतारसुवर्णं त्रिलोहम्, तत्र ताम्रं द्वादशभागं, तारं षोडशभागं, सुवर्णं त्रिभागं, एवं त्रिलोहभागप्रमाणेन तद्यन्त्रवेष्टनं ‘कृत्वा’ कारयित्वा ‘बाहौ कण्ठे च’ दक्षिणभुजे प्रीवायां च ‘धारयेत्’ ध्रियते । ‘स्त्रीसौभाग्यकरं यन्त्रं’ एतद् यन्त्रं दुर्भगस्त्रीणां सौभाग्यकरं भवति । ‘स्त्रीणां चेतोऽभिरञ्जकम्’ स्त्रीणां मनोऽभिरञ्जनं भवति ॥ स्त्रीणां सौभाग्यकरणे क्षवषड्रञ्जिकायन्त्रम् ॥

क्षाद्यक्षरपदे योज्यं लं शिलातलसम्पुटे ।

विलिख्योर्वीपुरं बाह्वे स्तम्भने तालकादिभिः ॥ २१ ॥

‘क्षाद्यक्षरपदे’ क्षकारादिवषडक्षरफट्स्थाने । ‘योज्यम्’ योजनीयम् । किम् ? ‘लं’ लकारम् । क्व ? ‘शिलातल-सम्पुटे’ । ‘विलिख्य’ लिखित्वा । किम् ? ‘उर्वीपुरं’ पृथ्वीपुरम् । क्व ? ‘बाह्वे’ त्रिमूर्तिवेष्टनबहिःप्रदेशे । कस्मिन् विषये ? ‘स्तम्भने’ क्रोधादिस्तम्भनकरणे । कैः ? ‘तालकादिभिः’ हरितालादिपीतद्रव्यैः ॥ क्रोधादिस्तम्भनकरणे लरञ्जिकायन्त्रम् ॥ इति द्वादशरञ्जिकोद्धारक्रमः ॥

इत्युभयभाषाकविशेखरश्रीमल्लिषेणसूरिविरचिते

भैरवपद्मावतीकल्पे द्वादशरञ्जिकायन्त्रो-

द्धारार्थिकारश्चतुर्थः परिच्छेदः ॥ ४ ॥

अथ पञ्चमः क्रोधादिस्तम्भनयन्त्रपरिच्छेदः ५ ।

क्षमठसहपलववर्णान् मलवरयूकारसंयुतान् विलिखेत् ।
अष्टदलेषु क्रमशो नाम ग्लौं कर्णिकामध्ये ॥१॥

‘क्षमठसहपलववर्णान् मलवरयूकारसंयुतान् विलिखेत् अष्टदलेषु’ क्षश्च मश्च ठश्च सश्च हश्च पश्च लश्च वश्च क्षमठसहपलवाः ते च ते वर्णाश्च तान् क्षमठसहपलववर्णान् । कथम्भूतान् ? ‘मलवरयूकारसंयुतान्’ मश्च लश्च वश्च रश्च यूकारश्च मलवरयूकाराः तैः संयुतान् मलवरयूकारसंयुतान् इति क्ष्म्ब्यूँ म्म्ब्यूँ ढ्म्ब्यूँ स्म्ब्यूँ ह्म्ब्यूँ प्म्ब्यूँ त्म्ब्यूँ ब्म्ब्यूँ इत्यष्टदलेषु । कथम् ? ‘क्रमशः’ प्राच्यादिदिशां क्रमपरिपाटया । ‘नाम ग्लौं कर्णिकामध्ये’ तदष्टदलान्तःस्थितकर्णिकामध्ये देवदत्तनामान्वितं ग्लौंकारं लिखेत् ॥

मन्त्राभ्यामावेष्टय बाह्ये भूमण्डलेन संवेष्टय ।
कुङ्कुमहरितालाद्यैर्विलिखेदात्मेप्सितस्तम्भः ॥ २ ॥

‘मन्त्राभ्याम्’ द्वाभ्यां मन्त्राभ्याम् । ‘आवेष्टय’ वेष्टयित्वा । ‘बाह्ये’ मन्त्रबहिःप्रदेशे । ‘भूमण्डलेन संवेष्टय’ पृथ्वीमण्डलेन सम्यगावेष्टय लिखेत् । कैः ? ‘कुङ्कुमहरितालाद्यैः’ काश्मीरहरितालादिपीतद्रव्यैः । ‘विलिखेत्’ विशेषेण लिखेत् । मन्त्रद्वयम्—

अग्निस्तम्भिनि ! पञ्चदिव्योत्तरणि ! श्रेयस्करि ! ज्वल ज्वल प्रज्वल प्रज्वल सर्वकामार्थसाधिनि ! स्वाहा ॥
ॐ अनलपिङ्गलोर्ध्वकेशिनि ! महादिव्याधिपतये स्वाहा । ॥ अग्निस्तम्भनयन्त्रम् ॥

त्रींकारं चिन्तयेद् वक्त्रे विवादे प्रतिवादिनाम् ।
त्रां वा रेफं ज्वलन्तं वा स्वेष्टसिद्धिप्रदायकम् ॥ ३ ॥

‘त्रींकारं चिन्तयेत्’ त्रीमित्यक्षरं चिन्तयेत् । क्व ? ‘वक्त्रे’ । कस्मिन् विषये ? ‘विवादे’ व्यवहारादिविषये । केषाम् ? ‘प्रतिवादिनाम्’ स्वप्रतिपक्षवादिनाम् । न केवलं त्रींकारम्, ‘त्रां वा’ त्रामित्यक्षरं वा चिन्तयेत् । ‘रेफं ज्वलन्तं वा’ रकारं जाज्वल्यमानं वा चिन्तयेत् । ‘स्वेष्टसिद्धिप्रदायकम्’ स्वकीयेप्सितसिद्धिप्रदायकं भवति ॥

नाम ग्लौं खान्तपिण्डं वसुदलसहिताम्भोजपत्रे लिखित्वा
तत्पिण्डान्तेषु योज्यं बहिरपि वलयं दिव्यमन्त्रेण कुर्यात् ।
टान्तं भूमण्डलान्तं विपुलतरशिलासम्पुटे कुङ्कुमाद्यै-
र्धार्यं श्रीवीरनाथक्रमयुगपुरतो वह्निदिव्योपशान्त्यै ॥ ४ ॥

‘नाम’ देवदत्तनाम । ‘ग्लौँ’ देवदत्तनामोपरि ग्लौँकारम् । ‘खान्तपिण्डं’ खकारम्यान्तो गकारः स चासौ पिण्डश्च खान्तपिण्डः ग्म्ब्यु इति पिण्डः तम् । ‘वसुदलसहिताम्भोजपत्रे विलिह्य’ अष्टदलान्वितपद्मपत्रे विशेषेण लिखित्वा । ‘तस्तिपिण्डं’ तत्कणिकालिखितग्म्ब्यु इतिपिण्डम् । ‘तेषु’ अष्टपत्रेषु । ‘योज्यम्’ योजनीयम् । ‘बहिरपि’ तदष्टदलकमलबहिःप्रदेशे । ‘वलयम्’ । केन ? ‘दिव्यमन्त्रेण’ विशिष्टमन्त्रेण । ‘कुर्यात्’ करोतु । ‘टान्तं’ ठकारम् । कथम्भूतम् ? ‘भूमण्डलान्तं’ पृथ्वीमण्डलान्तःस्थितम् । दिव्यमन्त्रवलयबहिःप्रदेशे ठकारेणावेष्ट्य तद्वहिः पृथ्वीमण्डलं लिखेत् इत्यभिप्रायः । क ? ‘विपुलतरशिलासम्पुटे’ विस्तीर्णपाषाणसम्पुटे केः ? ‘कङ्कुमाद्यैः’ काश्मीरादिपीतद्रव्यैः । ‘धार्यं’ धारणीयम् । क ? ‘श्रीवीरनाथक्रमयुगपुरतः’ श्रीवर्द्धमानस्वामिचरणयुगलाग्रतः । किमर्थम् ? ‘वह्निदिव्योपशान्त्रे’ अनलदिव्योपशान्त्यर्थम् ।

वलयमन्त्रोद्धारः

ॐ धम्भेइ जलज्जलणं चितियमितेण पंचणमयाते ।

अरिमरिचोरराउलघोरुवसगं विणासेइ१ ॥ स्वाहा२ ॥

प्राकृतमन्त्रोऽयम् । इदमग्निस्तम्भनयन्त्रम् ॥

दिव्येषु जलतुलाफणिखगेषु पवहक्षपिण्डमाविलिखेत् ।

पूर्वोक्ताष्टदलेष्वपि पूर्ववदन्यत् पुनः सर्वम् ॥ ५ ॥

‘दिव्येषु’ चतुर्षु दिव्येषु । कथम्भूतेषु ? ‘जलतुलाफणिखगेषु’ जलदिव्ये तुलादिव्ये घटसर्पदिव्ये पक्षिदिव्ये, एतेषु चतुर्षु दिव्येषु । ‘पवहक्षपिण्डं’ जलदिव्ये ग्म्ब्यु इतिपिण्डम्, तुलादिव्ये ग्म्ब्यु इतिपिण्डम्, फणिदिव्ये ह्म्ब्यु इतिपिण्डम्, पक्षिदिव्ये क्ष्म्ब्यु इति पिण्डम् । ‘आविलिखेत्’ समन्ताद्विलिखेत् । केषु ? ‘पूर्वोक्ताष्टदलेषु’ प्राग्विलिखिताष्टदलेषु । कथितचतुर्दिव्येषु पवहक्षपिण्डाः क्रमेण लेखनीयाः । अपिशब्दाद् मध्येऽपि च । ‘पूर्ववदन्यत् पुनः सर्वं’ अन्यत् पुनः यन्त्रोद्धारं प्राग्विलिखितं यथा तथैव सर्वम् ॥

ब्रह्मग्लौँकारपुटं टान्तावृतमष्टवज्रसंरुद्धम् ।

वामं वज्राग्रगतं तदन्तरे रान्तबीजं च ॥ ६ ॥

‘ब्रह्म’ उँकारसम्पुटम्, ग्लौँकारसम्पुटम् इति बीजद्वयम् । कथम्भूतम् ? ‘टान्तावृतम्’ ठकारावृतम् । पुनः कथम्भूतम् ? ‘अष्टवज्रसंरुद्धम्’ वज्राष्टकैः सम्यग रुद्धम् । ‘वामं वज्राग्रगतम्’ उँकारो वज्राणां अग्रे स्थितः । ‘तदन्तरे’ तद्वज्राग्रान्तराले ‘रान्तबीजं च’ रकारस्यान्तो लकारः स एव बीजं रान्तबीजं लं इति । ‘चः’ समुच्चये ॥

वार्तालीमन्त्रवृतं बाह्येऽष्टसु दिक्षु विन्यसेत् क्रमशः ।

मलवरयुंकारयुतान् क्षमठसहपरान्तलान्तांश्च ॥ ७ ॥

‘वार्तालीमन्त्रवृत्तं’ वज्राणां बहिःप्रदेशे वार्तालीमन्त्रेण वेष्टितम् । ‘बाह्ये’ मन्त्रावेष्टनबहिःप्रदेशे । ‘अष्टसु दिक्षु’ अष्टासु दिशासु । ‘विन्यसेत्’ विशेषेण स्थापयेत् । कथम् ? ‘क्रमशाः’ क्रम परिपाठ्या । ‘मलवरयुंकारयुतान्’ मध्व लध्व वध्व रध्व युंकारध्व मलवरयुंकाराः तैर्युताः मलवरयुंकारयुताः तान् मलवरयुंकारयुतान् । ‘क्षमठसहपरान्त-लान्तान्’ क्षध्व मध्व ठध्व सध्व हध्व पध्व लध्व वध्व, ‘रान्तो’ रकारस्यान्तो लकारः लध्व, ‘लान्तो’ लकारस्यान्तो वकारः वध्व, क्षमठसहपरान्तलान्ताः तान् । एवं क्ष्म्ळ्युं म्ळ्युं ठ्म्ळ्युं स्म्ळ्युं ह्म्ळ्युं प्म्ळ्युं ल्म्ळ्युं ठ्म्ळ्युं एतानष्ट पिण्डान् । वार्तालीमन्त्रोद्धारः—

ॐ वार्तालि ! वराहि ! वराहनुखि ! जम्भे ! जम्भिनि ! स्तम्भे ! स्तम्भिनि ! अन्धे ! अन्धिनि ! रुन्धे ! रुन्धिनि ! सर्वदुष्टप्रदुष्टानां क्रोधं लिलि मर्ति लिलि गर्ति लिलि जिह्वां लिलि ॐ २ ठः ठः ठः । अयं वार्तालीमन्त्रः ॥

बाह्येऽमरपुरपरिवृतमङ्कुशरुद्धं करोतु तद् द्वारम् ।

उक्षेशमन्त्रवेष्टयं पृथ्वीपुरसम्पुटं बाह्ये ॥ ८ ॥

‘बाह्ये’ तत्पिण्डाष्टकबहिःप्रदेशे । ‘अमरपुरपरिवृतम्’ इन्द्रपुरेण समन्तादावृतम् । ‘अङ्कुशरुद्धं करोतु तद् द्वारम्’ तद् इन्द्रपुरं चतुर्द्वारोभयपार्श्वे अङ्कुशः क्रौंकारः तेन रुद्धं कुर्यात् । ‘उक्षेशमन्त्रवेष्टयम्’ तत्पुरबहिःप्रदेशे उक्षा ऋषभस्तस्य ईशः स्वामी श्रीऋषभनाथः तस्य मन्त्रः तेन उक्षेशमन्त्रेणावेष्टयम् । ‘पृथ्वीपुरसम्पुटं बाह्ये’ । उक्षेशमन्त्रवल्लयबाह्ये पृथ्वीमण्डलसंपुटं कुर्यात् । उक्षेशमन्त्रोद्धारः—

ॐ नमो ३भयवदो रिसहस्स तस्स पडिनिमित्तेण ४चरणपणति इंदेण भणामइ यमेण ५उग्घाडिया जीहा कंठोट्टुसुहतालुया. खीलिया जो मं६भसइ जो मं हसइ दुट्टुदिट्टोए वज्जसंखिलाए देवदत्तस्स मणं हिययं कोहं जीहा खीलिया सेलखिलाए ल ल ल ल ७ ठ ठ ठ ठ ॥ उक्षेशमन्त्रोऽयं, प्राकृतमन्त्रः ॥

कोणेष्वष्टसु विलिखेद् वार्तालीमन्त्रभणितजम्भादीन् ।

ठद्वितयं धरणीपुरमीदृशमिदमालिखेत् प्राज्ञः ॥ ९ ॥

‘कोणेष्वष्टसु’ उक्षेशमन्त्रवल्लयबहिरष्टसु दिशासु । ‘विलिखेत्’ विशेषेण लिखेत् । कान ? ‘वार्तालीमन्त्रभणित-जम्भादीन्’ वार्तालीमन्त्राभ्यन्तरे कथितजम्भाद्यष्टदेवताः । ‘ॐ जम्भे ! स्वाहा, ॐ जम्भिनि ! स्वाहा, ॐ स्तम्भे ! स्वाहा, ॐ स्तम्भिनि ! स्वाहा, ॐ अन्धे ! स्वाहा, ॐ अन्धिनि ! स्वाहा, ॐ रुन्धे ! स्वाहा, ॐ रुन्धिनि ! स्वाहा, इत्यष्ट देवताः प्राच्याद्यष्टदिशासु क्रमेण स्थाप्याः । ‘ठद्वितयं’ जम्भादिदेवीबहिःप्रदेशे ठकारद्वितयम् । ‘धरणीपुरम्’ ठकारबहिःप्रदेशे पृथ्वीमण्डलम् । ‘ईदृशं’ अनेन कथितप्रकारेण । ‘इदं’ एतद्वार्ताल्यभिधानं यन्त्रम् । ‘आलिखेत्’ समन्ताद् लिखेत् । कः ? ‘प्राज्ञः’ विद्वान् ॥

फलके शिलातले वा हरितालमनःशिलादिभिलिखितम् ।

कोपगतिसैन्यजिह्वास्तम्भं विदधाति विधियुक्तम् ॥ १० ॥

१ गति लिलि इति ख पाठः । २ ठः ठः ठः ठः ठः क्रौं ह्रीं नमः स्वाहा इति ख पाठः ।

३ भगवतो इति खः पाठः । ४ पन्नसि इति ख पाठः । ५ उग्घाडिया इति ख पाठः । ६ हसइ जो वाचाहेइ इति ख पाठः । ७ बंध बंद ठः ठः ठः क्रौं ह्रीं नमः इति ख पाठः ।

‘फलके’ काष्ठकृतफलके । ‘शिलातले वा’ अथवा पाषाणपट्टे वा । ‘हरितालमनःशिलादिभिः’ हरितालमनः-शिलादिपीतद्रव्यैः । ‘लिखितं’ लिखितं सत् । किं करोति ? ‘कोपगतिःसैन्यजिह्वास्तम्भं’ कोपस्तम्भं गतिस्तम्भं सैन्यस्तम्भं जिह्वास्तम्भम् । ‘विदधाति’ विशेषेण करोति । कथम् ? ‘विधियुक्तम्’ यथाविधानयुक्ते सति ॥

॥ वार्तालीयन्त्रोद्धारः समाप्तः ॥

नाम ग्लौमुर्वीपुरं वं पं ग्लौंकारवेष्टितं कृत्वा ।

ह्रींकारचतुर्वलयं स्वनामयुक्तं ततो लेख्यम् ॥ ११ ॥

‘नाम’ देवदत्तनाम । ‘ग्लौं’ तन्नामोपरि ग्लौंकारम् । ‘उर्वीपुरं’ तदुपरि पृथ्वीमण्डलम् । ‘वं पं ग्लौंकार-वेष्टितं कृत्वा’ उर्वीपुरबहिःप्रदेशे ‘वं’ वंकारं, तस्योपरि ‘पं’ पंकारं, पंकारोपरि ग्लौंकारं, एतैरक्षरत्रयैर्वेष्टनं कारयित्वा । ह्रींकारचतुर्वलयम् । कथम्भूतम् ? ‘स्वनामयुक्तम्’ तद् ह्रींकारं स्वकीयनामान्वितम् । ‘ततः’ तस्मात् ह्रींकारात् । ‘लेख्यं’ लेखनीयम् ॥

ॐ उच्छिष्टपदस्याग्रे स्वच्छन्दपदमालिखेत् ।

ततश्चाण्डालिनि ! स्वाहा टान्तयुग्मकवेष्टितम् ॥ १२ ॥

‘ॐ’ उ इत्यक्षरम् । ‘उच्छिष्टपदस्य’ उच्छिष्टेतिपदं तस्य । ‘अग्रे’ उच्छिष्टपदस्याग्रे । ‘स्वच्छन्दपदं’ स्वच्छन्देतिपदम् । ‘आलिखेत्’ समन्तात् लिखेत् । ‘ततः चाण्डालिनि ! स्वाहा’ ततः स्वच्छन्दपदाच्च चाण्डालिनि ! स्वाहा इति । एवं मन्त्रोद्धारः—ॐ उच्छिष्ट स्वच्छन्द चाण्डालिनि ! स्वाहा ॥ इति मन्त्रविन्यासः ॥ ‘टान्तयुग्म-कवेष्टितम्’ ठकारद्वयेन वेष्टितम् ॥

पृथ्वीवलयं दत्त्वा पुरोक्तमन्त्रेण वेष्टयेद् बाह्ये ।

रजनीहरितालाद्यैर्भूर्ये विधिनाऽन्वितो विलिखेत् ॥ १३ ॥

‘पृथ्वीवलयं दत्त्वा’ टान्तयुग्मबाह्ये पृथ्वीमण्डलं दत्त्वा । ‘पुरोक्तमन्त्रेण’ पूर्वोक्त ‘ॐ उच्छिष्ट’ इत्यादि-मन्त्रेण । ‘वेष्टयेत्’ वेष्टनं कुर्यात् । ‘बाह्ये’ पृथ्वीमण्डलबहिःप्रदेशे । ‘रजनीहरितालाद्यैः’ हरितालहरिद्रागोदन्तादिपीत-द्रव्यैः । क ! ‘भूर्ये’ भूर्यपत्रे । ‘विधिना’ यथाविधानेन । ‘अन्वितः’ युक्तः । ‘विलिखेत्’ विशेषेण लिखेत् ॥

तत्कुलालकरमृत्तिकावृतं तोयपूरितघटे विनिक्षिपेत् ।

पार्श्वनाथमुपरिस्थमर्चयेद् दिव्यरोधनविधानमुत्तमम् ॥ १४ ॥

‘तत्’ तद् यन्त्रम् । ‘कुलालकरमृत्तिकावृतम्’ कुम्भकारकराप्रमृदा वेष्टितम् । ‘तोयपूरितघटे’ जलपरिपूर्णवघटे । ‘विनिक्षिपेत्’ निदध्यात् । ‘श्रीपार्श्वनाथं’ श्रीपार्श्वभट्टारकम् । कथम्भूतम् ? ‘उपरिस्थं’ तत्कुम्भस्योपरि स्थितम् । ‘अर्चयेत्’ पूजयेत् । ‘दिव्यरोधनविधानम्’ दिव्यस्तम्भकरणम् । ‘उत्तमं’ श्रेष्ठम् । दिव्यस्तम्भनयन्त्रमिदम् ॥

रिपुनामान्वितमान्तं मलवरयुंकारसंयुतं टान्तम् ।

तद्बाह्ये भूमिपुरं त्रिशूलभृतोग्रमृगवेष्टयम् ॥ १५ ॥

‘रिपुनामान्वितमान्तम्’ शत्रोर्नामयुक्तं ‘मान्तम्’ यकारम् । ‘मलवरयूकारसंयुतं’ मध्व लध्व बध्व रध्व यूकारश्च मलवरयूकाराः तैः संयुतम् । कम् ? ‘टान्तम्’ ठकारम् । एवं ठम्ब्यू इति बीजं, यकारबहिःप्रदेशे । ‘तद्बाह्ये भूमिपुरं’ तत्पिण्डबाह्ये पृथ्वीमण्डलम् । ‘त्रिशूलभूतोप्रमृगवेष्टयम्’ तत्पृथ्वीमण्डलबाह्ये त्रिशूलनेक-भूतक्रूरमृगजातैः ‘वेष्टयं’ परिवृतम् ॥

प्रतिरूपहस्तखड्गैर्निहन्यमानारिरूपपरिवेष्टयम् ।

शत्रोर्नामान्तरितं समन्ततो वेष्टयेत् पिण्डैः ॥ १६ ॥

‘प्रतिरूपहस्तखड्गः’ प्रतिशत्रुहस्तकृपाणैः । ‘निहन्यमानारिरूपपरिवेष्टयं’ निहन्यमानैः निःशेषेण हन्यमानैः ‘अरिरूपैः’ प्रतिशत्रुरूपैः परिवेष्टयम् । ‘शत्रोर्नामान्तरितं’ वैरिनामान्तरितम् । ‘समन्ततः’ शत्रुप्रति-शत्रुनाम्नोर्बाह्ये परितः । ‘वेष्टयेत्’ वेष्टनं कुर्यात् । कैः ? ‘पिण्डैः’ नामान्तरितठकारपिण्डैः ॥

प्रतिरिपुवाजिमहागजनामान्तरितं समन्ततो मन्त्रम् ।

विलिखेदौहूँह्रीँक्लौँ स्वाहा टान्तयुग्मान्तम् ॥ १७ ॥

‘प्रतिरिपु’ प्रतिशत्रुः तस्य ‘वाजिमहागजनामान्तरितं’ पद्माश्वगजनामान्तरितम् । ‘समन्ततः’ नामान्तरित-तठपिण्डबाह्ये परिसमन्तात् । ‘मन्त्रं’ मन्त्रवलयम् । ‘विलिखेत्’ विशेषेण लिखेत् ।

मन्त्रोद्धारः—उँ हूँ ह्रीँ क्लौँ स्वाहा ठ ठ देवदत्तस्य पद्मश्वे, उँ हूँ ह्रीँ क्लौँ स्वाहा ठ ठ देव-दत्तस्य पद्मगजे उँ हूँ ह्रीँ इत्यादि मन्त्रेण समन्ततो वेष्टयेत् ।

वेष्टनमन्त्रोद्धारः कथ्यते—उँ ह्रीँ भैरवरूपधारिणि ! चण्डशूलिनि ! प्रतिपक्षसैन्यं चूर्णय चूर्णय घूर्मय घूर्मय भेदय भेदय प्रस प्रस पञ्च पञ्च खादय खादय मारय मारय हूँ फट् स्वाहा ॥

मन्त्रेण वेष्टयित्वाऽनेन ततोऽरातिविग्रहो लेख्यः ।

अष्टासु दिक्षु बहिरपि माहेन्द्रं मण्डलं दद्यात् ॥ १८ ॥

‘मन्त्रेण वेष्टयित्वाऽनेन’ अनेन कथितमन्त्रेण वेष्टितं कृत्वा । ‘ततः’ तन्मन्त्रवेष्टनाद् बहिःप्रदेशे । अराति-विग्रहो लेख्यः’ शत्रुरूपं लेख्यम् । क ? ‘अष्टासु दिक्षु’ प्राच्याद्यष्टदिशासु । ‘बहिरपि’ विग्रहबहिःप्रदेशेऽपि । ‘माहेन्द्रं मण्डलं’ इन्द्रमण्डलम् । ‘दद्यात्’ देयम् ॥

प्रेतवनात् सञ्चालितमृतकमुखोज्जितपटेऽथवा विलिखेत् ।

कृष्णाष्टम्यां युद्ध्वा त्यक्तप्राणस्य सङ्ग्रामे ॥ १९ ॥

‘प्रेतवनात्’ श्मशानभूमेः सकाशात् । ‘सञ्चालितमृतकमुखोज्जितपटेऽथवा विलिखेत्’ सम्यगुच्चलित-मृतकमुखोज्जितपटेऽथवा प्रेतस्य प्रच्छादितबन्धे विलिखेत् । अथवा ‘कृष्णाष्टम्यां युद्ध्वा त्यक्तप्राणस्य सङ्ग्रामे’ कृष्णाष्टम्यां कृष्णचतुर्दश्यां ‘सङ्ग्रामे’ रणाङ्गणे युद्ध्वा कृतप्राणपरित्यागपुरुषस्य बन्धे वा विलिखेत् ॥

कन्याकर्तितसूत्रं दिवसेनैकेन तत्पुनर्वीतम् ।

तस्मिन् हरितालाद्यैः कोरण्टकलेखिनीलिखितम् ॥ २० ॥

‘कन्याकर्तितसूत्रं’ कुमार्या कर्तितं सूत्रम् । ‘तत्’ कुमार्या कर्तितसूत्रम् । ‘दिवसेनैकेन पुनर्वीतम्’ पुनरपि एकेन दिवसेन वाणतम् । ‘तस्मिन् हरितालाद्यैः’ तस्मिन् षष्ठे हरितालादिपीतद्रव्यैः । ‘कोरण्टकलेखिनी-लिखितम्’ कोरण्टकलेखिन्या लिखितम् ॥

पद्मावत्याः पुरतः पीतैः पुष्पैः पुरा समभ्यर्च्य ।

यन्त्रपटं बध्नीयात् प्रख्याते चान्तरे स्तम्भे ॥ २१ ॥

‘पद्मावत्याः पुरतः’ पद्मावतीदेव्यप्रतः । ‘पीतैः पुष्पैः पुरा समभ्यर्च्य’ पीतवर्णप्रसूनैः पूर्वं सम्यक् पूजयित्वा । ‘यन्त्रपटं’ एतल्लिखितयन्त्रपटम् । ‘बध्नीयात्’ निबध्नीयात् । ‘प्रख्याते’ विख्याते । ‘चः’ समुच्चये । ‘भान्तरे स्तम्भे’ अभ्यन्तरस्तम्भे ॥

तं दृष्ट्वा दूरतरान्नश्यन्ति भयेन विह्वलीभृताः ।

विरचितसेनाव्यूहात् सङ्ग्रामेशेषरिपुवर्गाः ॥ २२ ॥

‘तं दृष्ट्वा’ स्तम्भे निबद्धं यन्त्रपटं दृष्ट्वा । ‘दूरतरान्नश्यन्ति’ अतिदूरादेव ‘नश्यन्ति’ पलायन्ते । ‘भयेन विह्वलीभृताः’ भीत्या विकलीभृताः । कस्मात् ? ‘विरचितसेनाव्यूहात्’ विशेषेण रचितो विरचितः, विरचितश्चासौ सेनाव्यूहश्च विरचितसेनाव्यूहः तस्मात् । क्व ? ‘सङ्ग्रामे’ रणभूमौ । के ? ‘अशेषरिपुवर्गाः’ इतरशत्रुसमूहाः । नश्यन्तीति सम्बन्धः ॥

इत्युभयभाषाकविशेखरश्रीमल्लिषेणसूरिविरचिते

भैरवपद्मावतीकल्पे स्तम्भनयन्त्राधिकारः

पञ्चमः परिच्छेदः ॥ ५ ॥

षष्ठोऽङ्गनाकर्षणपरिच्छेदः ।

द्विरेफयुक्तं लिख मान्तयुगमं षष्ठस्वरौकारयुतं सविन्दु ।

स्वरावृतं पञ्च पुराणि वह्ने रेफात् क्रमात् क्रोमथ ह्रीं च कोणे ॥ १ ॥

‘द्विरेफयुक्तं’ रेफद्वयसंयुक्तम् । ‘लिख’ लेखय । किं तत् ? ‘मान्तयुगमम्’ मकारस्यान्तो मान्तो यकारः, तस्ययुगममिति यकारयुगलम् । किंविशिष्टम् ? ‘षष्ठस्वरौकारयुतम्’ षष्ठस्वरश्च औकारश्च षष्ठस्वरौकारौ ताभ्यां युतं षष्ठस्वरौकारयुतम्, ऊकार-औकारसंयुक्तम् । पुनः कथम्भूतम् ? ‘सविन्दु’ अनुस्वारेण संयुक्तम् । एवं यू यौ । पुनरपि कथम्भूतम् ? ‘स्वरावृतम्’ तद्बीजबहिःप्रदेशे षोडशकलाभिरावेष्टयम् । ‘पञ्चपुराणि वह्नेः’ आवृत-कलावेष्टनबहिःप्रदेशे पञ्चवह्निपुराणि । ‘रेफात् क्रमात् क्रोमथ ह्रीं च कोणे’ रेफाक्षरसकाशाद् यथानुक्रमेण क्रोमित्यक्षरम् । अथ’ क्रौकारादनन्तरम् । ‘ह्रीं’ ह्रीमिति बीजम् । ‘चः’ समुच्चये । क ? कोणे ॥

क्लृकाररुद्धं च तथा ह्रस्क्लीं व्लृकाररुद्धं च ह्रसौस्तथैव ।

क्रमेण दिक्षु त्रिषु चाम्बिकाया मन्त्रं बहिर्वह्निमरुत्पुरं च ॥ २ ॥

‘क्लृकाररुद्धं च’ क्लृकारद्वितयरुद्धम् । ‘तथा ह्रस्क्लीं’ तथा पूर्वोक्ताक्षरविधानेन ह्रस्क्लीं इति बीजाक्षरम् । ‘व्लृकाररुद्धं च’ व्लृकारयुगलरुद्धं च । ‘ह्रसौ तथैव’ ह्रसौ इति बीजाक्षरमपि । ‘क्रमेण’ प्रथममण्डलकोणत्रये ह्रीं इति बीजम्, द्वितीयमण्डलकोणत्रये क्रौं इति बीजम्, तृतीयमण्डलकोणत्रये ह्रीं इति बीजम्, चतुर्थ-मण्डलकोणत्रये क्लृकाररुद्धं ह्रस्क्लीं इति बीजम्, पञ्चममण्डलकोणत्रये व्लृकाररुद्धं ह्रसौः इति बीजम्, एवमनेन क्रमेण वह्निपञ्चपुराणि लेखनीयानि । ‘दिक्षु त्रिषु’ तन्मण्डलत्रिदिशासु ‘मन्त्रं’ वक्ष्यमाणमन्त्रम् । कस्याः ? ‘अम्बिकायाः’ अम्बिकायक्षिदेव्याः । ‘बहिः’ तन्मन्त्रबाह्ये । ‘वह्निमरुत्पुरं’ अग्निमण्डलं वायुमण्डलं च । अम्बिकामन्त्रोद्धारः—

ॐ नमो भगवति ! अम्बिके ! अम्बालिके ! यक्षिदेवि ! यूँ यौँ व्लृं ह्रस्क्लीं व्लृं ह्रसौः रर र र रां रां नित्यक्लिप्ते ! रेमदनद्रवे ! मदनातुरे ! ह्रीं क्रौं अमुकां मम वश्याकृष्टिं कुरु कुरु संवौषट् ॥

इष्टाङ्गनाकर्षणमाहुराद्या धत्तूरताम्बूलविषादिलेख्यम् ।

यन्त्रं पटे खर्परताम्रपत्रे दिनत्रये दीपशिखाभित्तम् ॥ ३ ॥

१ व्लृकार इति ख पाठः । २ रः रः रः रः रां रां इति ख पाठः । ३ मदद्रवे इति ख पाठः ।

४ आकृष्टिमिष्टप्रमदाजनानां करोति यन्त्रं खदिराभित्तम् ।

इति श्लोकार्धमधिकं दीपशिखाभित्तमित्यस्यानन्तरं पठयते ग पुस्तके ॥ तद्दीकाऽपि दृश्यते । सा यथा—‘आकृष्टि’ आकर्षणम् । कासाम् ? ‘इष्टप्रमदाजनानां’ स्वकीयेऽपिसितानामङ्गनानाम् । करोति’ कुरुते । किं तत् ? ‘यन्त्रं’ एतत् कथितयन्त्रम् । किंविशिष्टम् ? ‘खदिराभित्तम्’ खदिरकाष्ठान्नागतपत्तम् ॥

‘इष्टाङ्गनाकर्षणम्’ इष्टप्रमदाजनाकृष्टिम् । ‘आहुः’ ब्रूवन्ति । के ? ‘आद्याः’ पूर्वाचार्याः । कम् ? यन्त्रम् किंविशिष्टम् ? ‘धत्तूरताम्बूलविषादिलेह्यम्’ उन्मत्तरसः तन्मुखताम्बूलरसः ‘विषं’ शृङ्गीविषं आदिशब्दाद् उद्वर्तनादिभिः ‘लेह्यम्’ इत्यादिद्रव्यैर्लेखनीयम् । ‘यन्त्रम्’ कथितयन्त्रम् । क ? ‘पटे’ वस्त्रे । ‘खर्परे’ नूतन-खर्परे । ‘ताम्रपत्रे’ शुल्बपत्रे । ‘दिनत्रये’ त्रिदिने । ‘दीपशिखामितप्तम्’ प्रदीपशिखाज्वालातप्तम् ॥

ॐ ह्रीं हृत्कमले गजेन्द्रवशकं सर्वाङ्गसन्धिष्वपि

मायामाविलिखेत् कुचद्वितययोर्युं योनिदेशे तथा ।

क्रौंकारैः परिवेष्ट्य मन्त्रवलयं दद्यात् पुरं चानलं

तद्बाह्येऽनिलभूपुरं त्रिदिवसे दीपाम्निनाऽऽकर्षणम् ॥ ४ ॥

‘ॐ ह्रीं हृत्कमले’ हृदयकमलमध्ये ॐ ह्रीं इति बीजाक्षरं विलिखेत् । ‘सर्वाङ्गसन्धिषु’ सर्वशरीरसन्धिषु । ‘अपि’ तथा । ‘गजेन्द्रवशकं’ अङ्कुशम् । ‘कुचद्वितययोः’ स्तनद्वितययोः । ‘मायामाविलिखेत्’ ह्रींकारमाविलिखेत् । ‘तथा’ तेन प्रकारेण । ‘योनिदेशे’ योनिप्रदेशे । ‘युं’ युं इति बीजम् । ‘क्रौंकारैः परिवेष्ट्य’ तद्रूपबहिःप्रदेशे क्रौंकारैः समन्तात् वेष्टयित्वा । ‘मन्त्रवलयं दद्यात्’ तत्क्रौंकारवेष्टनानन्तरं ‘ॐ नमो भगवति ! कृष्णमातङ्गिनि !’ इत्यादि मन्त्रवेष्टनं दद्यात् । ‘पुरं चानलम्’ तन्मन्त्रवलयबहिः अग्निमण्डलं दद्यात् । ‘तद्बाह्येऽनिलभूपुरम्’ तदग्नि-मण्डलबहिःप्रदेशे वायुमण्डलं तदुपरि भूमण्डलं दद्यात् । ‘त्रिदिवसे दीपाम्निनाऽऽकर्षणम्’ दिनत्रयमध्ये प्रदीप-शिखाम्निना आकर्षणं स्यात् ॥

वलयमन्त्रोद्धारः—ॐ नमो भगवति ! कृष्णमातङ्गिनि ! शिलावत्कलकुसुमरूपधारिणि ! किरातशबरि ! सर्वजनमोहिनि ! सर्वजनवशंकरि ! ह्रीं ह्रीं ह्रीं ह्रीं हः अमुकां मम वश्याकृष्टिं कुरु कुरु संवोषट् ॥

पत्रे स्त्रीरूपमालिख्यमूर्ध्वपादमधःशिरः ।

ब्रह्मादिराजिकाधूमभानुदुग्धेन लेखयेत् ॥ ५ ॥

‘पत्रे’ ताम्रपत्रे । ‘स्त्रीरूपम्’ इष्टाङ्गनारूपम् । ‘आलिख्यं’ लिखित्वा । कथम् ? ‘ऊर्ध्वपादमधःशिरः’ पादवूर्ध्व शिरोऽधः कृत्वा लिखेत् । ‘ब्रह्मादि’ ब्रह्मादि—पलाशशुग्धत्तूरमिति अन्ये वदन्ति ब्रह्माविष्णुरुद्रेति त्रिपुरुषम् । ‘राजिका’ गौरसर्षपाः । ‘धूमं’ गृहधूमम् । ‘भानुदुग्धेन’ अर्कक्षोरेण लेखयेत् । एतैः द्रव्यैः कथितस्त्रीरूपं यन्त्रं लेखयित्वा दीपशिखानौ तापयेत् इत्यर्थः ॥

अग्निपुटकोष्ठमध्ये कलावृतं नाथमङ्कुशनिरुद्धम् ।

कोष्ठेषु प्रणवाङ्कुशमायारतिनाथरंश्च ॥ ६ ॥

१ वेषधारि इति ख पाठः २ सर्वजनमनोमोहिनी इति ख पाठः

३ लेपयुत् ख पाठः ।

‘अग्निपुटकोष्ठमध्ये’ शिखिमण्डलद्वयसम्पुटकोष्ठमध्ये । ‘कलावृतं’ षोडशकलाभिरावृतम् । कम् ? ‘नाथम्’ भुवननाथं ह्रींकारम् । कथम्भूतम् ? ‘अङ्कुशनिरुद्धम्’ तद्ह्रींकारोभयपार्श्वे क्रौंकारद्वयरुद्धम् । ‘कोष्ठेषु’ तदग्निपुटषट्कोणेषु । ‘प्रणवाङ्कुशमायारतिनाथरंरध’ प्रथमकोष्ठे उ, द्वितीयकोष्ठे कौं, तृतीयकोष्ठे ह्रीं, चतुर्थकोष्ठे क्लीं, पञ्चमकोष्ठे रं, षष्ठकोष्ठे रः ॥

कृष्णशुनकस्य जङ्घाशल्ये प्रविलिख्य मनुजरक्तेन ।

खदिराङ्गारैस्तप्ते सप्ताहादानयत्यबलाम् ॥ ७ ॥

‘कृष्णशुनकस्य’ असितभक्षणस्य । ‘जङ्घाशल्ये’ तच्छुनकदक्षिणजङ्घास्थि । ‘प्रविलिख्य’ प्रकर्षेण लिखित्वः । केन ? ‘मनुजरक्तेन’ नरहृदिरेण । ‘खदिराङ्गारैः’ खदिरकाष्ठाङ्गारैः । ‘तप्ते’ तापिते सति । ‘सप्ताहात्’ सप्तदिनमध्ये । ‘आनयति’ समानयति । काम् ? ‘अबलाम्’ वनिताम् ॥

अथवा रजस्वलाया वस्त्रे संलिख्य जलजनागिन्याः ।

पुच्छं विधाय वर्तिं तद्दीपादानयेन्नारीम् ॥ ८ ॥

‘अथवा’ अन्येन प्रकारेण वा । ‘रजस्वलायाः’ पुष्पवत्याः । ‘वस्त्रे’ तद्वस्त्रे । ‘संलिख्य’ प्राक्शुनकास्थि-लिखिताग्निपुटकोष्ठेत्यादि यन्त्रं सम्यग् लिखित्वा । ‘जलजनागिन्याः’ ‘जलोद्भवसर्पिन्याः’ । ‘पुच्छं विधाय वर्तिं’ नागिन्याः पुच्छं गृहीत्वा तद्वस्त्रमध्ये निक्षिप्य वर्तिं कृत्वा । ‘तद्दीपात्’ तद्वर्तिप्रबोधितदीपात् । ‘आनयेत्’ समानयेत् । काम् ? ‘नारीम्’ वनिताम् ॥

ह्रींकारमध्ये प्रविलिख्य नाम षट्कोणचक्रं बहिराविलेख्यम् ।

कोणेषु तत्त्वं त्रिषु चोर्ध्वकोणद्वये पुनर्युमधरों लिखेच्च ॥ ९ ॥

‘ह्रींकारमध्ये’ भुवननाथाधिपमध्ये । ‘प्रविलिख्य’ प्रकर्षेण लिखित्वा । किम् ? ‘नाम’ देवदत्तनाम । ‘षट्कोणचक्रम्’ षट्कोणम् । ‘बहिः’ तद्ह्रींकाराद् बहिः । ‘अलेख्यं’ समन्तादालेख्यम् । ‘कोणेषु’ षट्कोणेषु । ‘तत्त्वं’ ह्रींकारम् । ‘त्रिषु च’ अधोगतपार्श्वकोणद्वयम्, ऊर्ध्वगतकोणमेकम्, एवं कोणत्रये ह्रींकारं लिखेत् । ‘ऊर्ध्वकोणद्वये’ पार्श्वकोणद्वये । ‘पुनः’ पश्चात् । ‘युं’ यूं यूं इति लिखेत् । ‘अधरों लिखेच्च’, अधोगतमध्यकोणे उ लिखेत् । ‘चः’ समुच्चये ॥

पाशाङ्कुशौ कोणशिखान्तरस्थौ मन्त्रावृतं वायुपुरं च बाह्ये ।

आकृष्टिमिष्टप्रमदाजनानां करोति यन्त्रं खदिराग्निमतम् ॥ १० ॥

‘पाशाङ्कुशौ कोणशिखान्तरस्थौ’ षट्कोणचक्रकोणेषु पाशाङ्कुशौ ओं क्रौ । ‘मन्त्रावृतं’ षट्कोणचक्रबहिः वक्ष्यमाणमन्त्रेणावेष्टितम् । ‘वायुपुरं च बाह्ये’ तन्मन्त्रबलयबहिःप्रदेशे वायुमण्डलम् । ‘च’ समुच्चये । ‘आकृष्टिं’ आकर्षणम् । कासाम् ? ‘इष्टप्रमदाजनानां’ स्वेषितस्त्रीणाम् । ‘करोति’ कुरुते । किं तत् ? ‘यन्त्रम्’ कथित-षट्कोणयन्त्रम् । किंविशिष्टम् ? ‘खदिराग्निमतम्’ खदिरकाष्ठाग्निना तापितम् ॥

वलयमन्त्रोद्धारः—ॐ ह्रीं ह्रस्वीं ह्रसौं आं क्रौं व्यूँ नित्यकिलत्रे ! मदद्रवे ! मदनातुरे ! अमुकीं मम वरयाकृष्टिं कुरु कुरु सं वीषट् ॥

लिखित्वा ताम्रपत्रे वा श्मशानोद्भवखर्परे ।

तदङ्गमलधत्तूरविषाङ्गारप्रलेपिते ॥ ११ ॥

‘लिखित्वा’ आलिख्य । क ? ‘ताम्रपत्रे’ ताम्रविनिर्मितपत्रे । ‘वा’ अथवा । ‘श्मशानोद्भवखर्परे’ श्मशानजनित-
खर्परे । ‘तदङ्गमल’ इष्टाङ्गनापञ्चमलः ‘धत्तूर’ उन्मत्तकरसः ‘विष’ शृङ्गीविषम् ‘अङ्गार’ श्मशानाङ्गारः,
‘प्रलेपिते’ एतैः अङ्गमलादिद्रव्यैः ताम्रपत्रे प्रलेपिते सति ॥

ह्रीं वदने योनौ क्लें ह्रस्वीं कण्ठे स्मराक्षरं नाभौ ।

हृदये द्विरेफयुक्तं ह्रौंकारं नामसंयुक्तम् ॥ १२ ॥

‘ह्रीं वदने’ आस्ये ह्रींकारम् । ‘योनौ क्लें’ योनिमध्ये क्लें । ‘ह्रस्वीं कण्ठे’ कण्ठप्रदेशे ह्रस्वीं इति ।
‘स्मराक्षरं नाभौ’ नाभिप्रदेशे क्लेंकारम् । ‘हृदये द्विरेफयुक्तं ह्रौंकारं’ हृत्प्रदेशे अधऊर्ध्वरेफद्वययुक्तं
‘ह्रौंकारं’ ह्रौंमिति । किंविशिष्टं ह्रौंकारम् ? ‘नामसंयुक्तम्’ देवदत्तनामान्वितम् ॥

नाभितले क्लेंकारं वेदादिं मस्तके च संविलिखेत् ।

स्कन्धमणिबन्धकूर्परपदेषु तत्त्वं प्रयोक्तव्यम् ॥ १३ ॥

‘नाभितले क्लेंकारं’ नाभेरधःप्रदेशे क्लेंकारम् । ‘वेदादिं’ वेदस्य आदिर्वेदादिः उँकारः तं ‘मस्तके च’
शीर्षे च संविलिखेत् । ‘स्कन्धमणिबन्धकूर्परपदेषु तत्त्वं प्रयोक्तव्यम्’ स्कन्धप्रदेशे मणिबन्धप्रदेशे कूर्परप्रदेशे
पदद्वयप्रदेशे, एतेषु प्रदेशेषु ह्रौंकारः प्रकर्षेण योजनीयः ॥

हस्ततले व्यूँकारं सन्धिषु शाखासु शेषतो रेफान् ।

त्रिपुटितवह्निपुरत्रयमथ तद्बाह्यप्रदेशेषु ॥ १४ ॥

कोष्ठेषु भुवननाथं कोष्ठाग्रान्तरनिविष्टमङ्कुशं बीजम् ।

वलयं पद्मावत्या मन्त्रेण करोतु तद्बाह्ये ॥ १५ ॥

‘हस्ततले व्यूँकारम्’ करतले व्यूँकारं लिखेत् । ‘सन्धिषु शाखासु’ हस्तपादादिशाखासु ‘शेषतः’
अङ्गुल्यादिशाखासु ‘रेफान्’ रकारान् लिखेत् । ‘त्रिपुटितवह्निपुरत्रयम्’ एतत्क्रमेणोद्धरितपुत्तलिकाबहिःप्रदेशे

अग्निमण्डलत्रयसम्पुटं कुर्यात् । 'अथ' त्रिपुटिताग्निपुरानन्तरं 'तद्बाह्यप्रदेशेषु' तदग्निमण्डलबहिःप्रदेशेषु 'कोष्ठेषु' नवकोष्ठेषु 'भुवननाथम्' ह्रींकारं लिखेत् । 'कोष्ठाग्रान्तरनिविष्टमङ्कुशं बीजम्' कोष्ठाग्रेषु तदन्तरेषु च निवेशित-
क्रौंकारम् । 'वलयं' वेष्टनम् 'पद्मावत्याः' पद्मावतीदेव्याः 'मन्त्रेण' वक्ष्यमाणमन्त्रेण 'करोतु' कुर्यात्
'तद्बाह्ये' तन्मण्डलबाह्ये । वलयमन्त्रोद्धारः—

ॐ ह्रीं ह्रौं ह्रस्वलाँ पद्मे ! पद्मकटिनि ! अमुकां मम वश्याकृष्टिं कुरु कुरु संवौषट् ॥

अङ्कुशरोधं कुर्यात् तद्बाह्ये मायया त्रिधा वेष्टयम् ।

यावकमलयजचन्दनकाश्मीराद्यैरिदं लिखेद् यन्त्रम् ॥ १६ ॥

'अङ्कुशरोधं कुर्यात्' क्रौंकाररुद्धं कुर्यात् । क ? 'तद्बाह्ये' तन्मन्त्रवलयबहिःप्रदेशे 'मायया' ह्रींकारेण
'त्रिधा वेष्टयम्' त्रिप्रकारेणावेष्टयम् । 'यावकं' अलक्तकम्, 'मलयजं' श्रीगन्धम्, 'चन्दनम्' रक्तचन्दनम्,
'काश्मीरम्' कुङ्कुमम्, इत्यादि सुगन्धद्रव्यैः 'इदं लिखेद् यन्त्रम्' एतत् कथितयन्त्रं लिखेत् ॥

वस्त्रे रजस्वलायाः खदिराङ्गारेण तापयेद् धीमान् ।

कुरुते ऽभिलषितवनिताकृष्टिं सप्ताहमध्येन ॥ १७ ॥

'वस्त्रे रजस्वलायाः' पुष्पवत्या वसने लिखित्वा 'खदिराङ्गारेण तापयेत्' खदिरकाष्ठजनिताङ्गारेण तापनं
कुर्यात् । कः ? 'धीमान्' बुद्धिमान् । 'अभिलषितवनिताकृष्टिम्' अभिप्रेताङ्गनाकृष्टिम् 'कुरुते' कुर्यात् । कथम् ?
'सप्ताहमध्येन' सप्तदिनाभ्यन्तरतः ॥

रविदुग्धादिविलिप्ते युवतिकपालेऽथवा लिखेद् यन्त्रम् ।

पुरुषाकृष्टौ च पुनर्नृकपाले यन्त्रमेवेदम् ॥ १८ ॥

'रविदुग्धादि' अर्कक्षीर-स्नुहीक्षीर-गृहधूमराजिका-लवणेत्यादिभिः 'विलिप्ते' विशेषेण लिप्ते । कस्मिन् ?
युवतिकपाले'अथवा' प्राक्कथितरजस्वलावस्त्राभावे अनेन प्रकारेण वा 'लिखेद् यन्त्रम्' प्राक्कथितयन्त्रं विलिखेत् ।
'पुरुषाकृष्टौ च' पुरुषाकर्षणविषये 'पुनः' पश्चात् 'नृकपाले' पुरुषकपाले 'यन्त्रमेवेदम्' एतदेव यन्त्रं लिखेत् ॥

नाम तत्त्वविर्गमितं बहिरालिखेच्छिखिमण्डलं

रेफमन्त्रवृतं श्मशानजकर्परे विलिखेदिदम् ।

तापयेत् खदिराग्निना हिमकुङ्कुमादिभिरादरा-

दानयत्यबलां बलाद्दिनसप्तकैर्मदविह्वलाम् ॥ १९ ॥

‘नाम’ देवदत्तनाम, कथम्भूतम् ? ‘तत्त्वविगर्भितम्’ ह्रींकारमध्यस्थितम्, ‘बहिः’ ह्रींकाराद् बहिः प्रदेशे । ‘अलिखेत्’ समन्ताल्लिखेत् । किम् ? ‘शिखिमण्डलम्’ अग्निमण्डलम् ‘रेफमन्त्रवृत्तम्’ रकारमन्त्रवलयेन तदग्निमण्डलं वाह्ये वेष्ट्यम् । ‘इदम्’ एतद् यन्त्रम् ‘विलिखेत्’ लिखेत् । क्व ? ‘श्मशानजखर्परे’ प्रेतवनकर्परे । कैलिखेत् ? ‘हिमकुङ्कुमादिभिः’ कर्पूरकाश्मीरादिसुगन्धद्रव्यैः ‘आदरात्’ आदरेण । किं कुर्यात् ? ‘तापयेत्’ तापनं कुर्यात् । केन ? ‘खदिराग्निना’ खदिरकाष्ठजनिताग्निना । ‘आनयति’ समानयति । काम् ? ‘अबलाम्’ वनिताम् । कथम् ? ‘बलात्’ बलात्कारेण । कियत्कालेन ? ‘दिनसप्तकैः’ सप्तदिवसैः । ‘मदविह्वलाम्’ मदनाकुलिताम् ॥

वलयमन्त्रो द्वारः—

ॐ नमो भगवति ! चण्डि ! कात्यायनि ! सुभगदुर्भगयुवतिजनानाकर्षय आकर्षय १ ह्रीं र र र्थूं
संवौषट् देवदत्ताया हृदयं घे घे ॥

इत्युभयभापाकविशेखरश्रीमल्लिपेणसूरिविरचिते

भैरवपद्मावतीकल्पेऽङ्गनाकर्षणाधिकारः

षष्ठः परिच्छेदः ॥ ६ ॥

सप्तमो वशीकरणयन्त्रपरिच्छेदः ।

हंसावृताभिधानं लवरयषष्ठस्वरान्वितं कूटम् ।

बिन्दुयुतं स्वरपरिवृतमष्टदलाम्भोजमध्यगतम् ॥ १ ॥

‘हंसावृतम्’ हंस इति पदेनावृतं-वेष्टितम् । किं तत् ? ‘अभिधानम्’ देवदत्तनाम । ‘लवरयषष्ठस्वरान्वितम्’ लश्च वश्च रश्च यश्च षष्ठस्वरश्च ऊकारः एतैरन्वितं-युक्तम् । किं तत् ? ‘कूटम्’ क्षकारम् । पुनः कथम्भूतम् ? ‘बिन्दुयुतम्’ अनुस्वारसंयुक्तम्, एवं क्ष्म्ब्यू इति पिण्डं हंसपदाद् बहिर्देयम् । पुनरपि कथम्भूतम् ? ‘स्वरपरिवृतम्’ पिण्डाद् बहिः स्वरैरावेष्टितम् । पुनः कथम्भूतम् ? ‘अष्टदलाम्भोजमध्यगतम्’ अष्टदलकमलमध्ये स्थितम् ॥

तेजो हँ सोम सुधा हंसः स्वाहेति दिग्दलेषु लिखेत् ।

आग्नेय्यादिदलेष्वपि पिण्डं यत् कर्णिकालिखितम् ॥ २ ॥

‘तेजो हँ सोम सुधा हंसः स्वाहा’ तेजः-उँकारः, ‘हँ’ हँमिति अक्षरं, सोमः क्वीँकारः, सुधा क्ष्वीँकारः, ‘हंसः’ हंस इति पदम्, ‘स्वाहा’ स्वाहा इति पदम् । एवं उँ हँ क्वीँ क्ष्वीँ हंसः स्वाहा इत्येवंविशिष्टमन्त्रं ‘दिग्दलेषु’ प्राच्यादिषु चतुःपत्रेषु लिखेत् । ‘आग्नेय्यादिदलेष्वपि’ पश्चात् आग्नेय्यादिविदिग्गतचतुर्दलेषु ‘पिण्डं यत् कर्णिकालिखितम्’ यत् कर्णिकाभ्यन्तरे लिखितं क्ष्म्ब्यू इति पिण्डं विदिक्पत्रेषु लिखेत् ॥

भूर्ये सुरभिद्रव्यैर्विलिख्य तत् सिक्थकेन परिवेष्टय ।

नूतनघटेऽम्बुपूर्णे तद्यन्त्रं स्थापयेद् धीमान् ॥ ३ ॥

‘भूर्ये’ भूर्यपत्रे ‘सुरभिद्रव्यैः’ कुङ्कुमकर्पूरादिसुगन्धद्रव्यैः ‘विलिख्य’ विशेषेण लिखित्वा ‘तत्’ तल्लिरिवत-यन्त्रम् ‘सिक्थकेन’ मधुच्छिष्टेन ‘परिवेष्टय’ समन्ताद् आवेष्टय । ‘नूतनघटे’ नवकुम्भे । कथम्भूते ? ‘अम्बुपूर्णे’ शीतलजलपरिपूर्णे । ‘तद् यन्त्रं’ तत् सिक्थकेन वेष्टितं यन्त्रम् ‘स्थापयेत्’ निक्षिपेत् । कः ? ‘धीमान्’ बुद्धिमान् ॥

तन्दुलपूर्णं मृण्मयभाजनमप्युपरि तस्य संस्थाप्य ।

श्रीपार्श्वनाथसहितं करोति दाहज्वरोपशमम् ॥ ४ ॥

‘तन्दुलपूर्णम्’ शाल्यक्षतभरितम् ‘मृण्मयभाजनम्’ मृदा निर्मितपात्रम् ‘अपि’ पश्चात् ‘उपरि तस्य’ पूर्णकुम्भस्योपरि ‘संस्थाप्य’ सम्यक् स्थापयित्वा । कथम् ? ‘श्रीपार्श्वनाथसहितम्’ तन्दुलोपरि श्रीपार्श्वनाथ-जिनप्रतिमायुक्तम् । एवं विधानेन कृते सति ‘करोति’ कुस्ते । कम् ? ‘दाहज्वरोपशमम्’ दाहज्वरस्य शान्तिम् ॥

श्रीखण्डेन तदालिख्य पाययेत् कांस्यभाजने ।

महादाहज्वरग्रस्तं तत्क्षणेनोपशाम्यति ॥ ५ ॥

‘श्रीखण्डेन’ मखाभ्रयेण ‘तत्’ प्राक्कथितयन्त्रम् ‘आलिख्य’ लिखित्वा ‘पाययेत्’ आतुरं पाययेत् । तत् क्व लिखित्वा ? ‘कांस्यभाजने’ कांस्यनिर्मितपात्रे । कम् ? ‘महादाहज्वरग्रस्ताम्’ तीव्रोष्णज्वरगृहीतम् । ‘तद्’ दाहज्वरम् ‘क्षणेन’ निमिषमात्रेण ‘उपशाम्यति’ उपशमं प्राप्नोति ॥

मन्त्रोद्धारः—ॐ क्ष्म्भ्यूर् हँ क्वीँ क्ष्वीँ हंसः असिआउसा स्वाहा ।

१ क्लैतत्त्वकूटेन्दुवृतं स्वनाम तद्बाह्यभागेऽष्टदलाब्जपत्रम् ।
पत्रेषु पद्मावरमूलमन्त्रं वेष्टयं तदाकर्षणपल्लवेन ॥ ६ ॥

‘क्लैतत्त्वकूटेन्दुवृतम्’ ‘क्लै’ क्लेकारं, ‘तत्त्व’ ह्रींकारम्, ‘कटं’ क्षकारम्, ‘इन्दुः’ ठकारः, तैः ‘वृतम्’ एभिश्चतुर्बीजैरावेष्टितम् । किं तत् ? ‘स्वनाम’ स्वकीयनाम । ‘तद्बाह्यभागे’ तद्बीजाक्षरबहिःप्रदेशे । ‘अष्टदलाब्जपत्रम्’ अष्टदलकमलपत्रम् । ‘पत्रेषु’ तद्दलपत्रेषु ‘पद्मावरमूलमन्त्रम्’ पद्मावतीदेव्या विशिष्टमूलमन्त्रम् ‘वेष्टयं तद्’ तद् यन्त्रं वेष्टनीयम् । केन ? ‘आकर्षणपल्लवेन’ संवौषट् इति पल्लवेन ॥

मन्त्रोद्धारः—ॐ ह्रीँ हँ हस्क्लोँ पद्मे ! पद्मकटिनि ! नमः ॥

यन्त्रं ततश्चार्द्धशशिप्रवेष्टयं विलिख्य यन्त्रं फलके वटस्य ।
गोरोचनासंयुतकुङ्कुमाद्यैः साध्यस्य नामारुणचन्दनेन ॥७॥

‘यन्त्रम्’ एतत् कथितयन्त्रम् ‘ततः’ तस्माल्लेखनानन्तरम् ‘चः’ समुच्चये, ‘अर्द्धशशिप्रवेष्टयम्’ अर्द्धचन्द्ररेखया वेष्टयम् । ‘विलिख्य’ विशेषेण लिखित्वा ‘यन्त्रं’ एतद् यन्त्रम् । क्व ? ‘फलके’ पट्टिकायाम् । कस्य ? ‘वटस्य’ न्यग्रोधवृक्षस्य । कैः कृत्वा ? ‘गोरोचनासंयुतकुङ्कुमाद्यैः’ गोरोचनान्वितकुङ्कुमादिद्रव्यैः । ‘साध्यस्य नामारुणचन्दनेन’ साध्यमनुजनामान्वितं यन्त्रं रक्तचन्दनेन लेख्यम् ॥

कृत्वा ततश्चोभयसम्पुटं च श्रीपार्श्वनाथस्य पुरो निवेश्य ।

सन्ध्यासु नित्यं करवीरपुष्पैर्भवेदवश्यं जपतः सुसाध्यम् ॥ ८ ॥

‘ततः’ तस्मादनन्तरम् । ‘चः’ समुच्चये । ‘उभयसम्पुटं च’ साध्यसाधकयोर्लिखितयन्त्रसम्पुटम् ‘कृत्वा’ विरचय्य । ‘श्रीपार्श्वनाथस्य’ श्रीपार्श्वनाथतीर्थङ्करस्य ‘पुरः’ अग्रे ‘निवेश्य’ संस्थाप्य । कासु ? ‘सन्ध्यासु’ त्रिषु सन्ध्यासु । ‘नित्यं’ सर्वकालम् ‘जपतः’ जाप्यं कुर्वतः । कैः ? ‘करवीरपुष्पैः’ रक्तकरवीरपुष्पैः । जपतः पुरुषस्य ‘अवश्यं’ निश्चयेन ‘सुसाध्यं’ सम्यक् साध्यं ‘भवेत्’ स्यात् ॥

अन्त्यवर्गतृतीयतुर्यवकारतत्त्ववृताह्वयं

हंसवर्णवृतं ततो द्विगुणीकृताष्टदलाम्बुजम् ।

तेषु षोडश सत्कलाः शिरसोनश्चन्यवृतं बहि-

र्मायया परिवेष्टितं प्रणवादिकादिभिरावृतम् ॥ ९ ॥

‘अन्त्यवर्गः’ शवर्गः । ‘तृतीयः’ तस्य शवर्गस्य तृतीयाक्षरः सकारः । ‘तुर्यः’ चतुर्थः हकारः । ‘वकारः’ वकाराक्षरम् । ‘तत्त्वं’ ह्रींकारः । ‘वृताह्वयम्’ एतैश्चतुर्भिरक्षरैरावेष्टितदेवदत्तनाम । ‘हंसवर्णवृतम्’ तदक्षरचतुष्टयाद् बहिः ‘हंसः’ इतिवर्णैरावृतम् । ‘ततः’ हंसवल्यात् ‘द्विगुणीकृताष्टदलाम्बुजम्’ षोडशदलपद्मम् । ‘तेषु’ षोडशदलेषु ‘षोडश सत्कलाः’ अकारादिषोडशस्वराः । ‘शिरसोनमून्यवृतं बहिः’ तत्स्वराद् बहिः शिरोरहित-हकारैर्वेष्टितम् । ‘मायया’ ह्रींकारेण ‘परिवेष्टितम्’ समन्ताद् वेष्टितम् । ‘प्रणवादिकादिभिः’ तद् ह्रींकाराद् बहिःप्रदेशे प्रणव आदिर्येषां ते ककारादयः तैः कादिभिरावृतम् । उँक, उँख, उँग, उँघ, उँङ, उँच, इत्यनेन प्रकारेण हकारपर्यन्तं वेष्टनीयम् ॥

यन्त्रमाविलिखेदिदं हिमकुङ्कुमागुरुचन्दनै-

भूर्यके फलकेऽथवा भुवि गोमयेन विमार्जिते ।

प्रत्यहं विधिना समं जपतोऽरुणप्रसवैर्भृशं

तस्य पादसरोजषट्पदसन्निभं भुवनत्रयम् ॥ १० ॥

‘यन्त्रम्’ एतत्कथितयन्त्रम् ‘आविलिखेत्’ समन्तात् लिखेत् । कैः ? ‘हिमकुङ्कुमागुरुचन्दनैः’ कर्पूर-काश्मीरागुरुश्रीगन्धादिसुरभिद्रव्यैः । क्व ? ‘भूर्यके’ भूर्यपत्रे । ‘फलके’ वटफलके । ‘अथवा’ अन्येन प्रकारेण वा ‘भुवि’ पृथिव्याम् । ‘गोमयेन’ भूम्यपतितगोशकृता ‘विमार्जिते’ विलिप्ते ‘प्रत्यहं’ दिनं दिनं प्रति ‘विधिना’ यथाविधानेन ‘समं’ सह ‘जपतः’ जपं कुर्वतः । कैः ? ‘अरुणप्रसवैः’ रक्तकरवीरपुष्पैः । ‘भृशं’ अत्यर्थम् । ‘तस्य’ अनेन प्रकारेण जपतस्तस्य पुरुषस्य । ‘पादसरोजषट्पदसन्निभं’ पादकमलभ्रमरसदृशं । किम् ? ‘भुवनत्रयम्’ जगत्त्रयम् तस्य पुरुषस्य वशवर्ति स्यात् इत्यभिप्रायः ।

मन्त्रः—उँ ह्रीं ह्रस्वलोँ व्लूँ हँ असिआउसा अनाहतविद्यायै नमः ॥

ब्रह्मान्तरगतं नाम मायया परिवेष्टितम् ।

वेष्टितं कामराजेन बाह्ये षोडशपत्रकम् ॥ ११ ॥

‘ब्रह्मान्तरगतं’ उँकारमध्यस्थितम् ‘नाम’ देवदत्तनाम । कथम्भूतम् ? ‘मायया परिवेष्टितम्’ ह्रींकारेण परिवेष्टितम् । पुनरपि ह्रींकाराद् बहिः ‘कामराजेन’ क्लौंकारेण ‘वेष्टितं’ परिवेष्टितम् । ‘बाह्ये’ क्लौंकारबाह्ये ‘षोडशपत्रकं’ षोडशदलपद्मम् ॥

पञ्च बाणान् न्यसेत् तेषु स्वाहान्तौकारपूर्वकान् ।

तद्बाह्ये मायया वेष्टयं क्रौंकारेण निरोधयेत् ॥ १२ ॥

‘पञ्च बाणान्’ उँ द्रौं द्रौं क्लौं व्लूँ सः इति पञ्च बाणान् ‘न्यसेत्’ स्थापयेत् । केषु ? ‘तेषु’ प्रत्येकं

पत्रेषु 'न्यसेत्' विन्यसेत् । कथंभूतान् ? 'स्वाहान्तौकारपूर्वकान्' स्वाहाशब्दान्तान् एव 'उँ द्रां द्रीं क्लीं व्लं सः स्वाहा' इत्यादिरूपान् । तद्वाह्ये' तत्पत्रवाह्ये 'मायया वेष्टयम्' ह्रींकारेण त्रिधा वेष्टयम् । 'क्रौंकारेण निरोधयेत्' क्रौंकारेण निरोधनं कुर्यात् ।

भूर्यपत्रे पटे वाऽपि विलिखेच्च हिमादिभिः ।

हौं ह्रीं क्लीं व्लं सकारान्त्यमन्त्रं क्षोभकरं जपेत् ॥ १३ ॥

'भूर्यपत्रे' भूर्जदले 'पटे वा' वस्त्रे वा 'अपि' निश्चयेन 'विलिखेच्च' विशेषेण लिखेत् । कैः ? 'हिमादिभिः' कर्पूरादिसुगन्धद्रव्यैः । 'हौं ह्रीं क्लीं व्लं सकारान्त्यमन्त्रं' उँ हौं ह्रीं क्लीं व्लं सः इति मन्त्रम् 'क्षोभकरं' जनक्षोभकरम् 'जपेत्' जपं कुर्यात् ॥

अष्टदलकमलमध्ये स्वनाम तत्त्वं दलेषु चित्तभवम् ।

पुनरप्यष्टदलाम्बुजमिभवशकरणं ततो लेख्यम् ॥ १४ ॥

'अष्टदलकमलमध्ये' अष्टदलाम्बुजमध्ये कर्णिकायाम् 'स्वनाम तत्त्वं' स्वकीयनामान्वितं ह्रींकारम् । 'दलेषु चित्तभवम्' तदष्टदलेषु क्लींकारम् । 'पुनरप्यष्टदलाम्बुजम्' पुनरपि अष्टदलपद्मम् । 'ततः' तदष्टदलेषु 'इभवशकरणं' क्रौंकारः 'लेख्यं' लेखनीयः ॥

षोडशदलगतपद्मं क्लींकारं तदलेषु सुरभिद्रव्यैः ।

क्लीं क्लीं व्लं क्लींकारैस्तद् यन्त्रं वेष्टयेत् परितः ॥ १५ ॥

'षोडशदलपद्मम्' पूर्वोक्ताष्टपत्रबहिःप्रदेशे षोडशदलान्वितं पद्मं लिखेत् । 'क्लींकारं तदलेषु' तत्- षोडशदलेषु क्लींकारं लिखेत् । कैः ? 'सुरभिद्रव्यैः' सुगन्धिद्रव्यैः । 'क्लीं क्लीं व्लं क्लींकारैः' क्लीं क्लीं व्लं क्लीं इत्यक्षरचतुष्टयेन 'तद् यन्त्रम्' प्राग्लिखितयन्त्रम् 'वेष्टयेत्' वेष्टनं कुर्यात् । कथम् ? 'परितः' समन्तात् ॥

तद्वाह्येऽर्कशशिभ्यां जपतः शून्यैश्च पञ्चभिर्नित्यम् ।

नागनरामरलोकः क्षुभ्यति वश्यत्वमायाति ॥ १६ ॥

'तद्वाह्ये' तद्वेष्टनबहिःप्रदेशे 'अर्कशशिभ्याम्' आदित्यचन्द्राभ्यां वेष्टनीयम् । 'जपतः शून्यैश्च पञ्चभिर्नित्यम्' सर्वकालं हौं ह्रीं व्लं ह्रीं हः इति पञ्चशून्यैः जपं कुर्वतः पुरुषस्य 'नागनरामरलोकः क्षुभ्यति' नागलोकः मनुष्यलोकः देवलोकः इति लोकत्रयं तस्य क्षोभं याति, 'वश्यत्वमायाति' वशवर्तिस्त्वमेति ॥

अष्टौ लघुपाषाणान् दिशासु परिजप्य निक्षिपेद् धीमान् ।

चौरारिरौद्रजीवादभयं सम्पद्यतेऽटव्याम् ॥ १७ ॥

'अष्टौ लघुपाषाणान्' अष्ट क्षुद्रपाषाणान् 'दिशासु' पूर्वादिदिशासु 'परिजप्य' प्रकर्षेण जपित्वा 'निक्षिपेत्' स्थापयेत् । कः ? 'धीमान्' बुद्धिमान् । 'चौरारिरौद्रजीवात्' तस्करशत्रुरौद्रजीवैः सकाशात् 'अभयं सम्पद्यते' निर्भयं भवति । क्व ? 'अटव्याम्' अरण्ये ॥

मन्त्रः—ॐ नमो भगवदो अरिद्रुनेमिस्स अरिद्रुणे बंधेण बंधामि रक्खसाणं भूयाणं खेयराणं चोराणं दाढीणं साहणीणं महोरगाणं अण्णे जे के वि दुट्ठु संभवति तेसिं सव्वेसिं मणं मुहं गइं दिट्ठिं बंधामि धणु धणु महाधणु जः जः ठः ठः ठः हुं फट् । इत्यरिष्टनेमिमन्त्रं प्राकृतम् ॥

स्मरबीजयुतं शून्यं तत्त्वेनैकारवेष्टितम् ।
बाह्येऽष्टदलमम्भोजं नित्यक्लिन्ने ! मदद्रवे ! ॥ १८ ॥
मदनातुरे ! वषडिति विलिखेत् स्वाहान्तविनयपूर्वेण ।
त्रिभुवनवश्यमवश्यं प्रतिदिवसं भवति संजपतः ॥ १९ ॥

‘स्मरबीजयुतम्’ क्लींकारयुतम् । किं तत् ? ‘शून्यं’ हकारम् । एवं हक्लीं इति बीजम् । पुनः कथम्भूतम् ? ‘तत्त्वेनैकारवेष्टितम्’ हौंकारेणैकारेण वेष्टितम् । ‘बाह्ये’ तदैकारबाह्ये ‘अष्टदलमम्भोजम्’ अष्टदलकमलं लिखेत् । ‘नित्यक्लिन्ने ! मदद्रवे ! मदनातुरे ! वषड्’ इति मन्त्रं तद्दलेषु लिखेत् । ‘स्वाहान्तविनयपूर्वेण’ स्वाहाशब्दमन्त्रं उकारं पूर्वं कृत्वा लिखेत् । ‘त्रिभुवनवश्यम्’ भुवनत्रयवश्यम् ‘अवश्यं’ निश्चितम् ‘प्रतिदिवसम्’ दिनं दिनं प्रति ‘भवति’ स्यात् । ‘संजपतः’ सम्यग् जपं कुर्वतः पुरुषस्य ॥

मन्त्रोद्धारः—ॐ हक्लीं हौं ऐं नित्यक्लिन्ने ! मदद्रवे ! मदनातुरे ! ममामुकीं वश्याकृष्टिं कुरु कुरु वषट् स्वाहा ॥

वर्णान्तं मदनयुतं वाग्भवपरिसंस्थितं वसुदलाब्जम् ।
दिक्षु विदिक्षु च मायावाग्भवबीजं ततो लेख्यम् ॥ २० ॥

‘वर्णान्तं’ वर्णस्यान्तो वर्णान्तः हकारः तं हकारम् । कथम्भूतम् ? ‘मदनयुतम्’ क्लींकारयुतम् । हक्लीं इति । ‘वाग्भवपरिसंस्थितम्’ ऐंकारसमन्तात् स्थितम् । ‘वसुदलाब्जम्’ तदैकाराद् बहिरष्टदलपद्मम् । ‘दिक्षु विदिक्षु च मायावाग्भवबीजम्’ प्राच्यादिचतुर्दिशासु हौंकारबीजम्, आग्नेयादिचतुर्विदिशासु च ऐंकारबीजम् ‘ततो लेख्यम्’ तस्मान्निखनीयम् ॥

त्रैलोक्यक्षोभणं यन्त्रं सर्वदा पूजयेदिदम् ।
हस्ते बद्धं करोत्येव त्रैलोक्यजनमोहनम् ॥ २१ ॥

‘त्रैलोक्यक्षोभणं’ त्रैलोक्यवर्तिजनक्षोभकारि ‘यन्त्रं’ एतत् कथितयन्त्रम् । ‘सर्वदा’ सर्वकालं पूजयेत् ‘इदम्’ एतद् यन्त्रम् । ‘हस्ते बद्धं’ बाहौ बद्धम् ‘करोत्येव’ अवश्यं करोति ‘त्रैलोक्यजनमोहनम्’ त्रैलोक्यान्तर्बर्तिजनानां मोहनम् ॥ मन्त्रोद्धारः—ॐ ऐं हौं देवदत्तस्य सर्वजनवश्यं कुरु कुरु वषट् ॥

भ्रमयुगलं केशि भ्रम माते भ्रम विभ्रमं च मुह्यपदम् ।
मोहय पूर्णैः स्वाहा मन्त्रोऽयं प्रणवपूर्वगतः ॥ २२ ॥

‘भ्रमयुगलम्’ भ्रम भ्रम इतिपदद्वयम् । ‘केशि भ्रम’ केशि भ्रम केशि भ्रमेति पदद्वयम् । ‘माते भ्रम’ माते भ्रम माते भ्रमेति पदद्वयम् । ‘विभ्रमं’ विभ्रम विभ्रमेति पदद्वयम् । ‘चः’ समुच्चये । ‘मुख्यपदम्’ मुख्य मुखेति पदद्वयम् । ‘मोहय’ मोहय मोहय इति पदद्वयम् । ‘पूर्णैः’ सम्पूर्णैः । ‘स्वाहा’ स्वाहेतिपदम् । ‘मन्त्रोऽयम्’ अयं मन्त्रः ‘प्रणवपूर्वगतः’ उकारपूर्वकः ॥

अस्य मन्त्रोद्धारः—ॐ भ्रम भ्रम केशि भ्रम केशि भ्रम माते भ्रम माते भ्रम विभ्रम विभ्रम मुख्य मुख्य मोहय मोहय स्वाहा ॥

एतेन लक्षमेकं भूमिमसम्प्राप्तसर्षपैर्जप्त्वा ।

क्षिप्ते गृहदेहल्यामकालनिद्रां जनः कुरुते ॥ २३ ॥

‘एतेन’ कथितमन्त्रेण । ‘लक्षमेकम्’ एकं लक्षम् । ‘भूमिमसम्प्राप्तसर्षपैः’ भूम्यपतितसिद्धार्थैः । ‘जप्त्वा’ जपं कृत्वा । ‘क्षिप्ते’ निक्षिप्ते सति । क ? ‘गृहदेहल्याम्’ गृहोदुम्बरके । किं करोति ? ‘अकालनिद्रां’ आकस्मिकनिद्राम् । ‘जनः’ लोकः । ‘कुरुते’ कुर्यात् ॥

मृतविधवाब्राह्मण्याः पादतलालक्तकेन परिलिखितम् ।

तद्वक्त्रपिहितवस्त्रे विधवारूपं निराभरणम् ॥ २४ ॥

‘मृतविधवा’ पञ्चत्वप्राप्तरण्डायाः, कस्याः ? ‘ब्राह्मण्याः’ द्विजकुलप्रसूतायाः । ‘पादतलालक्तकेन’ तस्याः पादतलालक्तकेन । ‘परिलिखितं’ समन्ताल्लिखितम् । क ? ‘तद्वक्त्रपिहितवस्त्रे’ तन्मृतरण्डामुखप्रच्छादितवस्त्रे । कम् ? ‘विधवारूपम्’ रण्डारूपम् । ‘निराभरणम्’ आभरणरहितम् ॥

प्रणवं विच्चे मोहे स्वाहान्तं सप्तलक्षजाप्येन ।

एकाकिनी निशायां सिद्धयति सा यक्षिणी रण्डा ॥ २५ ॥

‘प्रणवं’ उकारम् । कथम्भूतम् ? ‘विच्चे मोहे स्वाहान्तम्’ विच्चे मोहे स्वाहाशब्दान्तम् । ‘सप्तलक्षजाप्येन’ सप्तलक्षप्रमाणमेतन्मन्त्रजापेन । ‘एकाकिनी’ एकाकिनी भूत्वा । ‘निशायां’ रात्रौ । ‘सिद्धयति’ सिद्धिं प्राप्नोति । कासौ ? ‘यक्षिणी रण्डा’ सा रण्डा यक्षिणी ॥ मन्त्रः—ॐ विच्चे मोहे स्वाहा ॥

यत् साधकाभिलषितं तत् तस्मै वस्तु सा ददात्येव ।

क्षोभं प्रयान्ति रण्डाः सर्वा अपि भुवनवर्तिन्यः ॥ २६ ॥

‘यत् साधकाभिलषितम्’ यत् किञ्चित् साधकपुरुषस्य मनोवाञ्छितम् । ‘तत्’ तद्वस्तु ‘तस्मै’ तस्मै साधकाय । ‘सा ददात्येव,’ सा यक्षिणी न केवलं वस्त्रेव ददाति, अपि तु ‘क्षोभं प्रयान्ति’ क्षोभं गच्छन्ति । काः ? ‘रण्डाः’ विधवाः । ‘सर्वा अपि भुवनवर्तिन्यः’ समस्ता अपि भुवनाभ्यन्तरवर्तिन्यः ॥

तत्त्वं मन्मथबीजस्य तलोपरि विचिन्तयेत् ।

पार्श्वयोरेव लंपिण्डं भ्रमन्तमरुणप्रभम् ॥ २७ ॥

‘तत्त्वं’ ह्रींकारम् । ‘मन्मथबीजस्य’ कामदेवबीजस्य क्लींकारस्य । ‘तलोपरि’ ततः क्लींकारार्धोपरिप्रदेशे ह्रीं हीमिति । ‘पार्श्वयोः’ तत्क्लींकारोभयपार्श्वयोः । एव । ‘लं पिण्डं’ क्लींकारम् । ‘विचिन्तयेत्’ ध्यानं कुर्यात् । कथम्भूतम् ? ‘भ्रमन्तं’ चक्रवद् भ्राम्यन्तम् । पुनः कथम्भूतम् ? ‘अरुणप्रभम्’ जपाकुसुमवर्णम् ॥

योनौ क्षोभं मूर्धनि विमोहनं पातनं ललाटस्थम् ।

लोचनयुग्मे द्रावं ध्यानेन करोतु वनितानाम् ॥ २८ ॥

‘योनौ क्षोभम्’ तदक्षरत्रयात्मके चक्राकारे वनितायोनौ ध्याने कृते वनिता क्षोभं प्रयाति । ‘मूर्धनि विमोहनम्’ तदेव ध्यानं वनितामस्तके कृते स्त्री मोहनम् । ‘पातनं ललाटस्थम्’ तदेव ध्यानं वनिताललाटे कृते सति सा विह्वलीभवति । ‘लोचनयुग्मे द्रावम्’ तदेव ध्यानं वनितादृष्टियुग्मे कृते सति द्रावो भवति । ‘ध्यानेन’ अनेन कथितध्यानेन । ‘करोतु’ क्षोभमित्यादि कर्म कुर्यात् । कासाम् ? ‘वनितानाम्’ स्त्रीणाम् ॥

शीर्षस्यहृदयनाभौ पादे चानङ्गबाणमथ योज्यम् ।

सम्मोहनमनुलोम्ये विपरीते द्रावणं कुर्यात् ॥ २९ ॥

‘शीर्षे’ मस्तके ‘आस्ये’ वदने ‘हृदये’ हृत्प्रदेशे ‘नाभौ’ नाभिप्रदेशे । ‘पादे’ पादयोः । ‘चः’ समुच्चये । ‘अनङ्गबाणम्’ द्रां द्रीं क्लीं ब्लूं सः इति पञ्चबाणान् । ‘अथ योज्यम्’ शीर्षादिषु पञ्चस्थानेषु क्रमेण योजनीयम् । ‘सम्मोहनमनुलोम्ये’ मूर्धादिपादान्तध्यानेन सम्मोहनम् । ‘विपरीते द्रावणं कुर्यात्’ तानेव पञ्च बाणान् पादादारभ्य क्रमेण मस्तकपर्यन्तं ध्यात्वा द्रावणं कुर्यात् । द्रां द्रीं क्लीं ब्लूं सः इत्यङ्गानुलोमस्थापने पञ्च बाणाः ॥

दद्यात् ताम्बूलगन्धादीन् स्मरबाणाभिमन्त्रितान् ।

क्षालयेदात्मवक्त्रं च स स्त्रीणां मन्मथो भवेत् ॥ ३० ॥

‘दद्यात्’ ददातु । कान् ? ‘ताम्बूलगन्धादीन्’ तांबूलश्रीखण्डगन्धपुष्पफलादीन् । कथम्भूतान् ? ‘स्मरबाणाभि-
मन्त्रितान्’ कामबाणमन्त्रेणाभिमन्त्रितान् । न केवलं ताम्बूलादीन्येव दीयन्ते ‘क्षालयेदात्मवक्त्रं च’ तन्मन्त्रेणो-
दकमभिमन्त्र्य स्ववदनं प्रक्षालयेच्च । ‘सः’ एवंविधः पुरुषः । ‘स्त्रीणाम्’ वनितानाम् । ‘मन्मथः’ कामदेवो ‘भवेत्’ ।

तत्पुष्पाभिमन्त्रण मन्त्रोद्धारः—ॐ द्रां द्रीं क्लीं ब्लूं सः ह्स्क्लीं ऐं नित्यक्लिन्ने ! मदद्रवे ! मदनातुरे !^१ सर्वजनं मम वश्यं कुरु कुरु वषट् ॥

विचिन्तयेदेव लपिण्डमेकं सिन्दूरवर्णं वनितावराड्डे ।

तद् द्रावणं दृष्टिनिपातमात्रात् स्यात्कर्षणं सप्तदिनानि मध्ये ॥ ३१ ॥

१ ह्रीं इति ख पाठः ।

२ सप्ताहतोऽप्यानयनं करोति । क पाठः ।

‘विचिन्तयेत्’ विशेषेण चिन्तयेत् । कम् ? ‘एव लपिण्डमेकम्’ क्लेकारमेकम् । कथम्भूतम् ? ‘सिन्दूरवर्ण’ सिन्दूरसदृशवर्णम् । क्व ? ‘वनितावराङ्गे’ स्त्रीणां योनीं । ‘तद् द्रावणं’ तच्चिन्तनं द्रावणं करोति । कस्मात् ? ‘दृष्टिनिपातमात्रात्’ ध्यानकर्तुः दृष्टिनिपातमात्रात् । न केवलं द्रावं मोहं च करोति, ^१ ‘ह्याकर्षणं सप्तदिनानि मध्ये’ सप्तदिनानां मध्ये ह्याकर्षणं करोति ॥

ब्राह्मणमस्तककेशैः कृत्वा रज्जुं तथा नरकपालम् ।

आवेष्ट्य साध्यदेहोद्वर्तनमलकेशनखरपादरजः ॥ ३२ ॥

मनुजास्थिचूर्णमिश्रं कृत्वा तन्निक्षिपेत् पुरोक्तपुटे ।

ज्वरयति मन्त्रस्मरणात् सप्ताहादस्थिमथनेन ॥ ३३ ॥ ॥ युगलम् ॥

‘ब्राह्मणमस्तककेशैः’ द्विजशिरोरुहैः । ‘कृत्वा रज्जुम्’ तच्छिरोरुहैः रज्जुं कृत्वा । ‘तथा’ रज्ज्वा । ‘नरकपालं’ नृकपालपुटम् । ‘आवेष्ट्य’ समन्ताद् वेष्टयित्वा । ‘साध्यदेहोद्वर्तनमलकेशनखरपादरजः’ साध्यपुरुषस्य शरीरोद्वर्तनमल-शिरोरुहनखपादरेणून् गृहीत्वा ‘मनुजास्थिचूर्णमिश्रम्’ नरास्थिचूर्णमिश्रम् । ‘कृत्वा’ विधाय । ‘तत्’ मलादिचूर्णम् । ‘निक्षिपेत्’ स्थापयेत् । क्व ? ‘पुरोक्तपुटे’ प्रागुक्तनृकपालपुटे । ‘ज्वरयति’ साध्यपुरुषं ज्वरेण गृह्णाति । कस्मात् ? ‘मन्त्रस्मरणात्’ उँ चण्डेश्वर ! इत्यादिमन्त्रचिन्तनात् । कथम् ? ‘सप्ताहात्’ सप्तदिनमध्यतः । केन ! ‘अस्थिमथनेन’ पुरुजास्थिकीलकमथनेन ।

मन्त्रोद्धारः—उँ चण्डेश्वर ! चण्डकुटारेण अमुकं ज्वरेण ह्यँ गृह्ण गृह्ण मारय मारय हूं फू धे धे ॥

चण्डेश्वराय होमान्तं सञ्जपेद् विनयादिना ।

सहस्रदशकं मन्त्री पूर्वमारुणपुष्पकैः ॥ ३४ ॥

‘चण्डेश्वराय’ चण्डेश्वरायेति पदम् । ‘होमान्तम्’ स्वाहाशब्दान्तम् । ‘सञ्जपेत्’ सम्यग्जपेत् । कथम् ? ‘विनयादिना’ उँकारपूर्वेण । ‘सहस्रदशकं’ दशसहस्रम् । कोऽसौ ? ‘मन्त्री’ मन्त्रवादी । कथम् ? ‘पूर्वम्’ पूर्वसेवायाम् । कैः ? ‘अरुणपुष्पकैः’ रक्तकरवीरपुष्पैः ॥

मन्त्रोद्धारः—उँ चण्डेश्वराय स्वाहा ॥ जाप्य सहस्रदश (१००००)

टान्तवकारप्रणवनजान्तार्द्धशशिप्रवेष्टितं नाम ।

शीतोष्णज्वरहरणं स्यादुष्णहिमाम्बुनिक्षिप्तम् ॥ ३५ ॥

‘टान्तवकार’ टान्तः—ठकारः । वकारः—व इत्यक्षरम् । ‘प्रणवनम्’ उँकारम् । ‘जान्तो’ झकारः । ‘अर्द्धशशिप्रवेष्टितम्’ अर्द्धचन्द्राकाररेखावेष्टितं एतैः ठकारादिपञ्चभिः ‘प्रवेष्टितम्’ प्रकर्षेण वेष्टितम् । किं तत् ? ‘नाम’ ज्वरगृहीतपुरुषनाम । ‘शीतोष्णज्वरहरणं स्यादुष्णहिमाम्बुनिक्षिप्तं’ एतद् यन्त्रं उष्णोदकमध्ये निक्षिप्तं शीतज्वरहरणं स्यात्, तदेव यन्त्रं शीतोदकमध्ये निक्षिप्तं उष्णज्वरहरणं स्यात् ॥

इदानीं होमद्रव्यविधानमभिधीयते—

१ ‘सप्ताहतोऽप्यानयनं करोति’ सप्तदिवसानां मध्ये ह्याकर्षणं करोति । क पाठः ।

२ कपालपुटे इति ख पाठः ।

तत्त्वं मन्मथबीजस्य तलोपरि विचिन्तयेत् ।

पार्श्वयोरेव लंपिण्डं भ्रमन्तमरुणप्रभम् ॥ २७ ॥

‘तत्त्वं’ ह्रींकारम् । ‘मन्मथबीजस्य’ कामदेवबीजस्य क्लींकारस्य । ‘तलोपरि’ ततः क्लींकारार्धोपरिप्रदेशे ह्रीं हीमिति । ‘पार्श्वयोः’ तत्क्लींकारोभयपार्श्वयोः । एव । ‘लं पिण्डं’ क्लैकारम् । ‘विचिन्तयेत्’ ध्यानं कुर्यात् । कथम्भूतम् ? ‘भ्रमन्तं’ चक्रवद् भ्राम्यन्तम् । पुनः कथम्भूतम् ? ‘अरुणप्रभम्’ जपाकुसुमवर्णम् ॥

योनौ क्षोभं मूर्धनि विमोहनं पातनं ललाटस्थम् ।

लोचनयुग्मे द्रावं ध्यानेन करोतु वनितानाम् ॥ २८ ॥

‘योनौ क्षोभम्’ तदक्षरत्रयात्मके चक्राकारे वनितायोनौ ध्याने कृते वनिता क्षोभं प्रयाति । ‘मूर्धनि विमोहनम्’ तदेव ध्यानं वनितामस्तके कृते स्त्री मोहनम् । ‘पातनं ललाटस्थम्’ तदेव ध्यानं वनिताललाटे कृते सति सा विह्वलीभवति । ‘लोचनयुग्मे द्रावम्’ तदेव ध्यानं वनितादृष्टियुग्मे कृते सति द्रावो भवति । ‘ध्यानेन’ अनेन कथितध्यानेन । ‘करोतु’ क्षोभमित्यादि कर्म कुर्यात् । कासाम् ? ‘वनितानाम्’ स्त्रीणाम् ॥

शीर्षास्यहृदयनाभौ पादे चानङ्गबाणमथ योज्यम् ।

सम्मोहनमनुलोम्ये विपरीते द्रावणं कुर्यात् ॥ २९ ॥

‘शीर्षे’ मस्तके ‘आस्ये’ वदने ‘हृदये’ हृत्प्रदेशे ‘नाभौ’ नाभिप्रदेशे । ‘पादे’ पादयोः । ‘चः’ समुच्चये । ‘अनङ्गबाणम्’ द्रां द्रीं क्लीं ब्लूं सः इति पञ्चबाणान् । ‘अथ योज्यम्’ शीर्षादिषु पञ्चस्थानेषु क्रमेण योजनीयम् । ‘सम्मोहनमनुलोम्ये’ मूर्धादिपादान्तध्यानेन सम्मोहनम् । ‘विपरीते द्रावणं कुर्यात्’ तानेव पञ्च बाणान् पादादारभ्य क्रमेण मस्तकपर्यन्तं ध्यात्वा द्रावणं कुर्यात् । द्रां द्रीं क्लीं ब्लूं सः इत्यङ्गानुलोमस्थापने पञ्च बाणाः ॥

दद्यात् ताम्बूलगन्धादीन् स्मरबाणाभिमन्त्रितान् ।

क्षालयेदात्मवक्त्रं च स स्त्रीणां मन्मथो भवेत् ॥ ३० ॥

‘दद्यात्’ ददातु । कान् ? ‘ताम्बूलगन्धादीन्’ तांबूलश्रीखण्डगन्धपुष्पफलादीन् । कथम्भूतान् ? ‘स्मरबाणाभि-
मन्त्रितान्’ कामबाणमन्त्रेणाभिमन्त्रितान् । न केवलं ताम्बूलादीन्येव दीयन्ते ‘क्षालयेदात्मवक्त्रं च’ तन्मन्त्रेणो-
दकमभिमन्त्र्य स्ववदनं प्रक्षालयेच्च । ‘सः’ एवंविधः पुरुषः । ‘स्त्रीणाम्’ वनितानाम् । ‘मन्मथः’ कामदेवो ‘भवेत्’ ।

तत्पुष्पाभिमन्त्रण मन्त्रोद्धारः—ॐ द्रां द्रीं क्लीं ब्लूं सः ह्स्क्लीं ऐं नित्यक्लिन्ने ! मदद्रवे ! मदनातुरे !^१ सर्वजनं मम वश्यं कुरु कुरु वषट् ॥

विचिन्तयेदेव लंपिण्डमेकं सिन्दूरवर्णं वनितावराङ्गे ।

तद् द्रावणं दृष्टिनिपातमात्रात् स्यात्कर्षणं सप्तदिनानि मध्ये ॥ ३१ ॥

१ ह्रीं इति ख पाठः ।

२ सप्ताहतोऽप्यानयनं करोति । क पाठः ।

‘विचिन्तयेत्’ विशेषेण चिन्तयेत् । कम् ? ‘एव लपिण्डमेकम्’ क्लेकारमेकम् । कथम्भूतम् ? ‘सिन्दूरवर्णं’ सिन्दूरसदृशवर्णम् । क्व ? ‘वनितावराज्ञे’ स्त्रीणां योनौ । ‘तद् द्रावणं’ तच्चिन्तनं द्रावणं करोति । कस्मात् ? ‘दृष्टिनिपातमात्रात्’ ध्यानकर्तुः दृष्टिनिपातमात्रात् । न केवलं द्रावं मोहं च करोति, ^१‘ह्याकर्षणं सप्तदिनानि मध्ये’ सप्तदिनानां मध्ये ह्याकर्षणं करोति ॥

ब्राह्मणमस्तककेशैः कृत्वा रज्जुं तथा नरकपालम् ।

आवेष्ट्य साध्यदेहोद्वर्तनमलकेशनखरपादरजः ॥ ३२ ॥

मनुजास्थिचूर्णमिश्रं कृत्वा तन्निक्षिपेत् पुरोक्तपुटे ।

ज्वरयति मन्त्रस्मरणात् सप्ताहादस्थिमथनेन ॥ ३३ ॥

॥ युगलम् ॥

‘ब्राह्मणमस्तककेशैः’ द्विजशिरोरुहैः । ‘कृत्वा रज्जुम्’ तच्छिरोरुहैः रज्जुं कृत्वा । ‘तथा’ रज्ज्वा । ‘नरकपालं’ नृकपालपुटम् । ‘आवेष्ट्य’ समन्ताद् वेष्टयित्वा । ‘साध्यदेहोद्वर्तनमलकेशनखरपादरजः’ साध्यपुरुषस्य शरीरोद्वर्तनमल-शिरोरुहनखपादरेणुन् गृहीत्वा ‘मनुजास्थिचूर्णमिश्रम्’ नरास्थिचूर्णमिश्रम् । ‘कृत्वा’ विधाय । ‘तत्’ मलादिचूर्णम् । ‘निक्षिपेत्’ स्थापयेत् । क्व ? ‘पुरोक्तपुटे’ प्रागुक्तनृकपालपुटे । ‘ज्वरयति’ साध्यपुरुषं ज्वरेण गृह्णाति । कस्मात् ? ‘मन्त्रस्मरणात्’ ॐ चण्डेश्वर ! इत्यादिमन्त्रचिन्तनात् । कथम् ? ‘सप्ताहात्’ सप्तदिनमध्यतः । केन ! ‘अस्थिमथनेन’ पुरुषास्थिकीलकमथनेन ।

मन्त्रोद्धारः—ॐ चण्डेश्वर ! चण्डकुठारेण अमुकं ज्वरेण ह्यौ गृह्ण गृह्ण मारय मारय हूं फ् घे घे ॥

चण्डेश्वराय होमान्तं सञ्जपेद् विनयादिना ।

सहस्रदशकं मन्त्री पूर्वमारुणपुष्पकैः ॥ ३४ ॥

‘चण्डेश्वराय’ चण्डेश्वरायेति पदम् । ‘होमान्तम्’ स्नाहाशब्दान्तम् । ‘सञ्जपेत्’ सम्यग्जपेत् । कथम् ? ‘विनयादिना’ ॐकारपूर्वेण । ‘सहस्रदशकं’ दशसहस्रम् । कोऽसौ ? ‘मन्त्री’ मन्त्रवादी । कथम् ? ‘पूर्वम्’ पूर्वसेवायाम् । कैः ? ‘अरुणपुष्पकैः’ रक्तकरवीरपुष्पैः ॥

मन्त्रोद्धारः—ॐ चण्डेश्वराय स्वाहा ॥ जाप्य सहस्रदश (१००००)

टान्तवकारप्रणवनजान्तार्द्धशशिप्रवेष्टितं नाम ।

शीतोष्णज्वरहरणं स्यादुष्णहिमाम्बुनिक्षिप्तम् ॥ ३५ ॥

‘टान्तवकार’ टान्तः—ठकारः । वकारः—व इत्यक्षरम् । ‘प्रणवनम्’ ॐकारम् । ‘जान्तो’ झकारः । ‘अर्द्धशशिप्रवेष्टितम्’ अर्द्धचन्द्राकाररेखावेष्टितं एतैः ठकारादिपञ्चभिः ‘प्रवेष्टितम्’ प्रकर्षेण वेष्टितम् । किं तत् ? ‘नाम’ ज्वरगृहीतपुरुषनाम । ‘शीतोष्णज्वरहरणं स्यादुष्णहिमाम्बुनिक्षिप्तं’ एतद् यन्त्रं उष्णोदकमध्ये निक्षिप्तं शीतज्वरहरणं स्यात्, तदेव यन्त्रं शीतोदकमध्ये निक्षिप्तं उष्णज्वरहरणं स्यात् ॥

इदानीं होमद्रव्यविधानमभिधीयते—

१ ‘सप्ताहतोऽप्यानयनं करोति’ सप्तदिवसानां मध्ये ह्याकर्षणं करोति । क पाठः ।

२ कपालपुटे इति ख पाठः ।

शाल्यक्षतदूर्वाङ्कुरमलयजहोमेन शान्तिकं पुष्टिम् ।

करवीरपुष्पहवनात् स्त्रीणां कुर्याद् वशीकरणम् ॥ ३६ ॥

‘शाल्यक्षतदूर्वाङ्कुरमलयजहोमेन’ कलमाक्षतश्चेतदूर्वाङ्कुरश्रीगन्धद्रव्यहवनेन । ‘शान्तिकं पुष्टिम्’ शान्तिकर्म पुष्टिकर्म च कुर्यात् । ‘करवीरपुष्पहवनात्’ । ‘स्त्रीणां’ वनितानाम् । ‘वशीकरणं’ वश्यकर्म कुर्यात् ॥

महिषाक्षपद्महोमात् प्रतिदिवसं भवति पुरजनक्षोभः ।

क्रमुकफलपत्रहवनात् राजानो वश्यमायान्ति ॥ ३७ ॥

‘महिषाक्षपद्महोमात्’ गुग्गुलुपद्महवनात् । ‘प्रतिदिवसं भवति पुरजनक्षोभः’ दिनं दिनं प्रति पुरजनक्षोभो भवति । ‘क्रमुकफलपत्रहवनात्’ पूगफलनागवल्लीपत्रहवनात् । ‘राजानो वश्यमायान्ति’ सर्वे पार्थिवा वश्यं गच्छन्ति ॥

तिलधान्यानां होमैराज्ययुतैर्भवति धान्यधनवृद्धिः ।

मल्लिप्रसूनहोमात् सघृताद् वश्या नियोगिजनाः ॥ ३८ ॥

‘तिलधान्यानां होमैः’ तिलादिधान्यहवनैः । कथम्भूतैः ? ‘आज्ययुतैः’ घृतान्वितैः । ‘भवति धान्यधनवृद्धिः’ धान्यधनवृद्धिः स्यात् । ‘मल्लिप्रसूनहोमात्’ मल्लिकापुष्पहोमात् । कथम्भूतात् ? ‘सघृतात्’ गवाज्ययुक्तात् । ‘वश्या नियोगिजनाः’ नियोगिजना वश्या भवन्ति ॥

घृतयुक्तचूतफलनिकरहोमतो भवति खेचरी वश्या ।

वटयक्षिणी च होमाद् भवति वशा ब्रह्मपुष्पाणाम् ॥ ३९ ॥

‘घृतयुक्तचूतफलनिकरहोमतः’ आज्ययुताम्रफलसमूहहवनात् । ‘भवति’ स्यात् । ‘खेचरी’ खेचरी नाम देवी । ‘वश्या’ वश्या भवतीत्यर्थः । ‘वटयक्षिणी च’ वटयक्षिणी नाम देवी च । ‘ब्रह्मपुष्पाणाम्’ पलाशपुष्पाणाम् । ‘हवनात्’ होमात् । ‘भवति वशा’ वशीभवति ॥

गृहधूमनिम्बराजीलवणान्वितकाकपक्षकृतहोमैः ।

एकोदरजातानामपि भवति परस्परं वैरम् ॥ ४० ॥

‘गृहधूम’ आगारधूम । ‘निम्बः’ पिचुमन्दः । ‘राजी’ कृष्णसर्षपः । ‘लवणम्’ सामुद्रम् । ‘अन्वितैः’ एतैर्युक्तैः ‘काकपक्षकृतहोमैः’ वायसपक्षकृतहोमैः । ‘एकोदरजातानाम्’ एकोदरसमुत्पन्नपुरुषाणाम् । ‘अपि’ निश्चयेन । ‘परस्परं वैरम्’ । ‘भवति’ जायते ॥

प्रेतवनशल्यमिश्रितविभीतकाङ्गारसद्मधूमानाम् ।

होमेन भवति मरणं पक्षाहाद् वैरिलोकस्य ॥ ४१ ॥

‘प्रेतवनशल्यमिश्रितविभीतकाङ्गारसद्मधूमानाम्’ श्मशानास्थियुक्तभूतवृक्षाङ्गारगृहधूमानाम् । ‘होमेन’ हवनेन । ‘भवति’ जायते । किं तत् ? ‘मरणम्’ पञ्चत्वम् । कथम् ? ‘पक्षाहात्’ पक्षदिनमध्यतः । कस्य ? ‘वैरिलोकस्य’ शत्रुजनस्य ॥

इत्युभयभाषाकविशेखरश्रीमल्लिषेणसूरिविरचिते

भैरवपद्मावतीकल्पे वश्यमन्त्राधिकारः

• सप्तमः परिच्छेदः ॥ ७ ॥

अष्टमो दर्पणादिनिमित्तपरिच्छेदः ॥८॥

सिद्धयति सहस्रजाप्यैर्दशगुणितैः प्रणवपूर्वहोमान्तैः ।

दर्पणनिमित्तमन्त्रश्चले चुले चूले प्रभृतिनोच्चार्यः ॥ १ ॥

‘सिद्धयति’ सिद्धिं प्राप्नोति । कैः ? ‘सहस्रजाप्यैः’ । कथम्भूतैः ? ‘दशगुणितैः’ दशसहस्रैरित्यभिप्रायः । पुनः कथम्भूतैः ? ‘प्रणवपूर्वहोमान्तैः’ उकारपूर्वस्वाहाशब्दान्त्यैः । ‘दर्पणनिमित्तमन्त्रः’ आदर्शनिमित्तमन्त्रः उच्चार्यः ॥ मन्त्रोद्धारः—उँ चले चुले चूडे(ले) कुमारिकयोरङ्गं प्रविश्य यथाभूतं यथाभाव्यं यथासत्यं^१ मा विलम्ब्य ममाशां पूर्य पूर्य स्वाहा ॥

सप्तवाराभिमन्त्रितगोदुग्धं पाययेत् कुमारिकयोः ।

ब्राह्मणकुलप्रसूत्योस्तयोर्द्वयोः सप्तवत्सरयोः ॥ २ ॥

‘सप्तवाराभिमन्त्रितम्’ कथितमन्त्रेण सप्तवाराभिमन्त्रितम् । किम् ? ‘गोदुग्धम्’ गोक्षीरम् । ‘पाययेत्’ पानं कारयेत् । ‘कुमारिकयोः’ कन्ययोः । किंविशिष्टयोः ? ‘ब्राह्मणकुलप्रसूत्योः’ विप्रवंशसजातयोः । पुनः कथम्भूतयोः ? ‘सप्तवत्सरयोः’ सप्तवार्षिकयोः । ‘तयोर्द्वयोः’ उभयोः ॥

संस्नाप्य ततः प्रातर्दत्त्वा ताभ्यामथ प्रसूनादीन् ।

भूम्यामपतितगोमयसम्मार्जितभूतले स्थित्वा ॥ ३ ॥

‘संस्नाप्य’ सम्यक्स्नपयित्वा । ‘ततः’ स्नानानन्तरम् । ‘प्रातः’ प्रभातसमये । दत्त्वा ‘ताभ्याम्’ कुमारीभ्याम् । ‘अथ’ पश्चात् । ‘प्रसूनादीन्’ पुष्पाक्षतानुलेपनादीन् । ‘भूम्याम्’ पृथिव्याम् । ‘अपतितम्’ न पतितम् । ‘गोमयं’ शकृत् । ‘सम्मार्जित भूतले’ तेन गोशकृता सम्यग्मार्जितभूतले । ‘स्थित्वा’ उषित्वा ॥

चतुरस्रमण्डलस्थं कलशं गन्धोदकेन परिपूर्णम् ।

तस्योपर्यादर्शं निवेशयेत् पश्चिमाभिमुखम् ॥ ४ ॥

‘चतुरस्रमण्डलस्थम्’ समचतुरस्रमण्डलमध्यस्थितम् । कं तम् ? ‘कलशम्’ घटम् । कथम्भूतम् ? ‘गन्धोदकेन परिपूर्णम्’ सुगन्धद्रव्यान्वितोदकेन परिपूर्णम् । ‘तस्योपरि’ तत्पूर्णकुम्भस्योपरि । ‘आदर्शं’ दर्पणम् । ‘निवेशयेत्’ स्थापयेत् । कथम् ? ‘पश्चिमाभिमुखम्’ प्रतीच्यभिमुखम् ॥

तदभिमुखे प्राक्कल्पितकुमारिकायुगलमथ निवेश्य ततः ।

तद्दृष्टये ब्लूकारं विचिन्तयेत् प्रणवसम्पुटितम् ॥ ५ ॥

‘अथ’ पश्चात् । ‘तदभिमुखे’ तद्दर्पणामिमुखे । ‘प्राक्कल्पितकुमारिकायुगलम्’ पूर्वं स्नानादिकसङ्कल्पितकन्याया युग्मम् । ‘निवेश्य’ तन्मण्डले संस्थाप्य । ‘ततः’ पश्चात् । ‘तद्दृष्टये’ तत्कुमारिकायुगलदृष्टये । ‘ब्लूकारं’ ब्लूमिति बीजाक्षरम् । ‘विचिन्तयेत्’ विशेषेण ध्यायेत् । कथम् ? ‘प्रणवसम्पुटितम्’ उकारसम्पुटितम् । उँ ब्लू उँ इत्यांकारसम्पुटितम् ॥

१ दर्शय दर्शय भगवती इति ख पाठः ।

शशिमण्डलवत् सौम्यं तन्मन्त्रमनुस्मरन् स्वयं तिष्ठेत् ।
आदर्शवीक्ष्यमाणं कुमारिकायुगलकं पृच्छेत् ॥ ६ ॥

‘शशिमण्डलवत् सौम्यं’ चन्द्रमण्डलवत्सौम्यरूपम् । ‘तन्मन्त्रम्’ वक्ष्यमाणमन्त्रम् । ‘अनुस्मरन् स्वयं तिष्ठेत्’ मन्त्रवाद्यात्मना तिष्ठेत् । ‘आदर्शवीक्ष्यमाणं कुमारिकायुगलकम्’ कन्यकायुगलम् । ‘पृच्छेत्’ प्रष्टव्यम् ॥

यद् दृष्टं यच्छ्रुतं ताभ्यां तत्र रूपं वचो यथा ।

खड्गाङ्गुष्ठे जलादर्शं तत् सत्यं नान्यथा भवेत् ॥ ७ ॥

‘यद् दृष्टम्’ यत् तत्र दृष्टम् । ‘यच्छ्रुतम्’ यत् तत्र श्रुतम् । ‘ताभ्याम्’ कुमारिकाभ्याम् । ‘तत्र’ मुकुरादि-निमित्ते । ‘रूपं वचो यथा’ येन प्रकारेण दृष्टं रूपम्, आकर्णितं वचनम् । क्व ? ‘खड्गाङ्गुष्ठजलादर्शं’ खड्गाङ्गुष्ठनिमित्ते, जलपूर्णकलशे, दर्पणनिमित्ते । ‘तत् सत्यम्’ यद् दृष्टम्, यच्छ्रुतं तत् सर्वं तथ्यम् । ‘नान्यथा भवेत्’ अन्ये प्रकारेणासत्यं किमपि न भवति ॥

दर्पणाङ्गुष्ठदीपादिनिमित्तमवलोकयेत् ।

सिध्यत्यष्टसहस्रेण मन्त्रो जाप्येन मन्त्रिणाम् ॥ ८ ॥

‘दर्पणाङ्गुष्ठदीपादि निमित्तं अवलोकयेत्’ निरीक्षेत । ‘सिध्यति’ सिद्धिं प्राप्नोति । ‘अष्टसहस्रेण’ सहस्राष्टकेन । कोऽसौ ? ‘मन्त्रः’ वक्ष्यमाणमन्त्रः । ‘जाप्येन’ जपनेन । केषाम् ? ‘मन्त्रिणाम्’ मन्त्रवादिनाम् । तदाराधनमन्त्रोद्धारः—ॐ नमो मेरु महामेरु, ॐ नमो गौरी महागौरी, ॐ नमः काली महाकाली, ॐ इन्द्रे महाइन्द्रे, ॐ जये महाजये, ॐ नमो विजये महाविजये, ॐ नमः पण्णसमणि महापण्णसमणि, अवतर अवतर देवि अवतर अवतर^२ स्वाहा ॥

दत्त्वा दर्भास्तरणं दुग्धाहारं पुरा कुमारिकयोः ।

संस्नाप्य ततः प्रातर्ध्वलाम्बरभूषणादीनि ॥ ९ ॥

‘दत्त्वा’ । किम् ? ‘दर्भास्तरणम्’ दर्भशय्याम् । ‘दुग्धाहारम्’ क्षीराहारम् । कथम् ? ‘पुरा’ निशि प्रथमयामे । कयोः ? ‘कुमारिकयोः’ । ‘ततः’ तदनन्तरम् । ‘प्रातः’ प्रभातसमये । ‘संस्नाप्य’ सम्यक्स्नपयित्वा । ‘ध्वलाम्बर-भूषणादीनि’ श्वेतवस्त्रालङ्कारादीनि ॥

कलशादर्शकुमारीस्थानेष्वथ विन्यसेदिमं मन्त्रम् ।

विनयं गजवशकरणं क्षांक्षींक्षूंकारहोमान्तम् ॥ १० ॥

‘कलशादर्शकुमारीस्थानेषु’ कलशस्थापने, दर्पणस्थापने, कुमारीस्थापने, एतेषु स्थानेषु । ‘अथ’ पश्चात् ।

१ यत् श्रुतं इति ख पाठः ।

२ हौं स्वाहा इति ख पाठः ।

‘विन्यसेत्’। कम्? ‘इमं मन्त्रम्’ वक्ष्यमाणमन्त्रम्। ‘विनयं गजवशकरणं क्षौं क्षौं क्षूँकारहोमान्तम्’ उकारं विनय इति सञ्ज्ञम्, गजवशकरणं—क्रोंकारम्, क्षांकारम्, क्षींकारम्, क्षूँकारम् ‘होमान्तम्’ स्वाहाशब्दान्तम् ॥ स्थानत्रयसंस्थापनमन्त्रोद्धारः—ॐ कौं क्षौं क्षीं क्षूँ स्वाहा। एतन्मन्त्रं स्थानत्रये विन्यसेत् ॥

प्रणवादिपञ्चशून्यैरभिमन्त्र्य कुमारिकाकुचस्थाने ।

अशितुं तयोश्च दद्याद् घृतेन सम्मिश्रितान् पूपान् ॥ ११ ॥

‘प्रणवादिपञ्चशून्यैः’ उकारादि हौं ह्रीं ह्रूं ह्रीं हः इति पञ्चशून्यैः। ‘अभिमन्त्र्य’ मन्त्रयित्वा। क ? ‘कुमारिका-कुचस्थाने’ कन्यास्तनयुगलस्थाने। ‘तयोः’ द्वयोः कुमारिकयोः। ‘च’ पुनः। ‘अशितुम्’ भक्षयितुम्। ‘दद्यात्’ दातव्यम्। कान्? ‘पूपान्’ पोलिकाः। कथम्भूतान्? ‘घृतेन सम्मिश्रितान्’ आज्ययुक्तान् ॥

आलक्तकाभिरञ्जितहस्ताङ्गुष्ठे निरीक्षयेद् रूपम् ।

करनिर्वर्तिततैलेनाङ्गुष्ठस्नानकरणेन ॥ १२ ॥

‘आलक्तकाभिरञ्जितहस्ताङ्गुष्ठे’ मन्त्रिदक्षिणकराङ्गुष्ठे। ‘निरीक्षयेत्’ अवलोकयेत्। किम्? ‘रूपम्’ प्रतिबिम्बम्। केन? ‘करनिर्वर्तिततैलेन’ हस्ताभ्यां मर्दिततैलेन। कथम्भूतेन? ‘अङ्गुष्ठस्नानकरणेन’ मन्त्र्यङ्गुष्ठेन तैलाभ्यक्तेन अङ्गुष्ठनिमित्तमिदम् ॥

प्रणवः पिंगलयुगलं पण्णत्तिद्वितयं महाविद्येयम् ।

टान्तद्वयं च होमो दर्पणमन्त्रो जिनोद्दिष्टः ॥ १३ ॥

‘प्रणवः’ उकारः। ‘पिंगलयुगलं’ पिंगल पिंगलेतिपदद्वयम्। ‘पण्णत्तिद्वयं च’ पण्णत्ति पण्णत्तीतिपदद्वयं च। ‘महाविद्येयम्’ इयं महाविद्या। ‘टान्तद्वयं’ टकारद्वयम्। ‘च’। ‘होमः’ स्वाहा। इति ‘दर्पणमन्त्रः’ आदर्शमन्त्रः। ‘जिनोद्दिष्टः’ जिनेश्वरप्रणीतः ॥ मन्त्रः—ॐ पिंगल पिंगल पण्णत्ति पण्णत्ति^१ ठठ स्वाहा ॥

जाप्यं भानुसहस्रैः सितपुष्पैश्चन्द्रकिरणसङ्काशैः ।

सिद्धयति दशांशहोमादादर्शनिमित्तमन्त्रोऽयम् ॥ १४ ॥

‘जाप्यं’ जपम्। ‘भानुसहस्रैः’ द्वादशसहस्रैः। कैः? ‘सितपुष्पैः’ श्वेतप्रसूनैः। कथम्भूतैः? ‘चन्द्रकिरणसङ्काशैः’ चन्द्ररश्मिसन्धिभैः। ‘सिद्धयति’ सिद्धिं याति। केन? ‘दशांशहोमेन’ द्वादशसहस्राणां दशांशहोमेन। ‘आदर्शनिमित्त-मन्त्रोऽयम्’ अयं मन्त्रः दर्पणनिमित्तसाधनम् ॥

चित्तभस्मनैकविंशतिवारान्^२सम्मर्द्य दर्पणं पूर्वम् ।

शाल्यक्षतोपरि स्थितनवाम्बुपरिपूर्णनवकुम्भे ॥ १५ ॥

१ महाविद्ये ठः ठः इति ख पाठः।

२ विमृशेच्च इति क पाठः।

‘चितभस्मनैकविंशतिवारान्’ । ‘सम्मर्द्य’ मर्दयित्वा । कम् ? दर्पणम्’ । ‘शाल्यक्षतोपरिस्थित’ कलमाक्षत-
पूजोपरिस्थित । ‘नवाम्बुपरिपूर्णनवकुम्भे’ अग्रोदकपरिपूर्णनवकुम्भे ॥

तं प्रतिनिधाय तस्मिन्नेककुलोद्भूतकन्यकायुगलम् ।

त्रिषु वर्णेष्वन्यतमं स्नातं धवलाम्बरोपेतम् ॥ १६ ॥

‘तं प्रतिनिधाय’ तं आदर्शं कुम्भस्योपरि संस्थाप्य । ‘तस्मिन्’ तत्कुम्भसमीपे । ‘एककुलोद्भूतकन्यकायुगलम्’
एककुलजनितकन्यकायुगलम् । किंविशिष्टम् ? ‘त्रिषु वर्णेष्वन्यतमं’ ब्राह्मणक्षत्रियवैश्यानां मध्ये सत्कन्यकायुगलं प्राप्य,
तदेकम् । पुनः कथम्भूतम् ? ‘स्नातम्’ कृतस्नानम् । ‘धवलाम्बरोपेतम्’ श्वेतवस्त्रपरिधानान्वितम् ॥

अभ्यर्च्य गन्धतन्दुलनिवेद्यकुसुमादिभिस्ततः कलशम् ।

दत्त्वा ताम्बूलादीन् आदर्शं दर्शयेत् ताभ्याम् ॥ १७ ॥

‘अभ्यर्च्य’ सम्यग् अर्चयित्वा । कैः ? ‘गन्धतन्दुलनिवेद्यकुसुमादिभिः’ गन्धाक्षतवरपुष्पदीपधूपपाद्यष्टविधार्चन-
द्रव्यैः । ‘ततः’ तस्मात् । ‘कलशं’ पूर्णकुम्भम् । ‘दत्त्वा ताम्बूलादीन्’ ताम्बूलगन्धाक्षतकुसुमादीन् दत्त्वा । ‘आदर्शं
दर्शयेत्’ । ‘ताभ्याम्’ कुमारिकाभ्याम् ॥

मन्त्रं प्रपठंस्तिष्ठेत् कुमारिकायुगलकं तथा पृच्छेत् ।

दृष्टं श्रुतं च कथयति रूपं वचनं च मुकुरान्ते ॥ १८ ॥

‘मन्त्रं प्रपठन्’ मन्त्रं उच्चारयन् । ‘तिष्ठेत्’ निवसेत् । ‘कुमारिकायुगलकम्’ कन्यकायुगलम् । ‘तथा’ तेन
प्रकारेण । ‘पृच्छेत्’ प्रश्नं कुर्वीत । ‘दृष्टं श्रुतं च कथयति’ यद् दृष्टं यच्छ्रुतं तत्सर्वं कथयति । ‘रूपं वचनं
च मुकुरान्ते’ आदर्शं यद् दृष्टं रूपं यच्छ्रुतं वचनं तत्कथयति ॥ इति दर्पणावतारः ।

इदानीं दीपनिषद्या कथ्यते—

अष्टसहस्रैर्जातीपुष्पैः श्रीवीरनाथजिनपुरतः ।

जप्ते सुन्दरदेवी सिद्धयति मन्त्रेण सद्भक्त्या ॥ १९ ॥

‘अष्टसहस्रैः’ सहस्राष्टकैः । ‘जातीपुष्पैः’ मालतीप्रसूनैः । ‘श्रीवीरनाथजिनपुरतः’ श्रीवर्द्धमानस्वामिजिनस्याग्रे ।
‘जप्ते’ जाप्ये कृते सति । ‘सुन्दरदेवी’ सुन्दरीनाम देवी । ‘सिद्धयति’ सिद्धिं प्राप्नोति । केन ? ‘मन्त्रेण’ वक्ष्यमाण-
मन्त्रेण । कथम् ? ‘सद्भक्त्या’ सद्भक्तिविशेषेण ॥

आराधनामन्त्रोद्धारः—ॐ सुन्दरि ! १परमसुन्दरि ! स्वाहा ।

ब्रह्मादिसुन्दरीशब्दं होमान्तं कर्णिकान्तरे ।

अष्टपत्रेषु सर्वेषु लिखेत् परमसुन्दरी ॥ २० ॥

‘ब्रह्मादिसुन्दरीशब्दं’ उकारादि सुन्दरीपदम् । ‘होमान्तं’ स्वाहान्तम् । ‘कर्णिकान्तरे’ ॐ सुन्दरि ! स्वाहा इति

कर्णिकाभ्यन्तरे लिखेत् । 'अष्टपत्रेषु सर्वेषु' तत्कर्णिकाबहिःप्रदेशे अष्टदलेषु । 'लिखेत् परमसुन्दरी' उ परमसुन्दरी स्वाहा इति पदं प्रत्येकं सर्वदलेषु लिखेत् ॥

कृष्णतिलतैलपूर्णं कुलालकरमृत्तिकाकृते पात्रे ।

आलक्तककृतवर्त्या दीपे न्यग्रोधवह्निभवे ॥ २१ ॥

'कृष्णतिलतैलपूर्णं' कृष्णतिलोद्भूततैलसम्पूर्णं । पुनः कथम्भूते ? 'कुलालकरमृत्तिकाकृते' कुम्भकारकराग्र-
गृहीतमृत्तिकया कृते । कस्मिन् ? 'पात्रे' दीपपात्रे । 'आलक्तककृतवर्त्या' आलक्तकपटलावेष्टितवर्त्या । 'दीपे'
प्रदीपे । कथम्भूते ? 'न्यग्रोधवह्निभवे' वटवृक्षकाष्ठजनिताग्निप्रज्वलिते । कुमारिकाद्यष्टविधार्चनं प्राक्कथितविधान-
वज्ज्ञात्वा कर्तव्यम् । दीपनिमित्तमिदम् ॥

इदानीं कर्णपिशाचीविधानमभिधीयते —

श्रवणपिशाचिनि मुण्डे ! स्वाहान्तः प्रणवपूर्वकोच्चार्यः ।

सिद्धयति च लक्षजाप्यात् कर्णपिशाचीत्ययं मन्त्रः ॥ २२ ॥

'श्रवणपिशाचिनि मुण्डे !' श्रवणपिशाची मुण्डे ! इति पदम् । 'स्वाहान्तः' स्वाहाशब्दान्त्यः । पुनः कथम्भूतः ?
'प्रणवपूर्वकोच्चार्यः' उकारमादि कृत्वोच्चारितः । 'सिद्धयति च लक्षजाप्यात्' लक्षप्रमाणजाप्यात् सिद्धिं प्राप्नोति ।
'कर्णपिशाचीत्ययं मन्त्रः' अयं मन्त्रः कर्णपिशाची नाम स्यात् ॥

मन्त्रोद्धारः—ॐ १ श्रवणपिशाचिनि मुण्डे ! स्वाहा ॥

मन्त्रपरिजसकुष्ठं हन्मुखकर्णाङ्घ्रियुगलमालिष्य ।

सुप्तस्य कर्णमूले कथयति यच्चिन्तितं कार्यम् ॥ २३ ॥

'मन्त्रपरिजसकुष्ठं' कर्णपिशाचिनीमन्त्रेणैकदिशतिवाराभिमन्त्रितं कुष्ठं उदकपेषितम् । 'हन्मुखकर्णाङ्घ्रि-
युगलमालिष्य' एतेनोदकेन पिष्टकुष्ठेन हृदयवदनश्रवणयुगलपादयुगलानि लेपयित्वा । 'सुप्तस्य' निद्रितस्य । 'कर्णमूले'
श्रवणमूले । 'कथयति' वदति । 'यच्चिन्तितं कार्यं' यद् अतीतानागतवर्त्तमानेष्वितं प्रयोजनम् ॥

२ मलयुंकारचतुर्दशकलान्वितं कूटबीजकं विलिखेत् ।

शिखिवायुमण्डलस्थं सनामखरताडपत्रगतम् ॥ २४ ॥

'मलयुंकारचतुर्दशकलान्वितं' मश्च लक्ष युंकारश्च चतुर्दशकला च औंकारः तैः 'अन्वितम्' आवृतं
मलयुंकारचतुर्दशकलान्वितम् । कम् ? 'कूटबीजकं' क्षकारबीजकम् । एवं क्षम्ल्यां ईदृशं बीजम् । 'विलिखेत्'
एतद् बीजाक्षरं लिखेत् । कथम् ? 'शिखिवायुमण्डलस्थं' अग्निपुरवायुपुरमध्यस्थितम् । पुनरपि कथम्भूतम् ?
'सनामखरताडपत्रगतम्' देवदत्तनामान्वितखरताडपत्रे स्थितम् ॥

१ उँ ह्रीं श्रवणपिशाचिनी इति ख पाठः ।

२ मलयुंकार इति ख पाठः ।

मार्तण्डस्नुहिदुग्धं त्रिकटुकहयगन्धसद्मभवधूमैः ।

आलिप्य ललाटस्थं गृहिणां कुरुते गृहावेशम् ॥ २५ ॥

‘मार्तण्डस्नुहिदुग्धं’ अर्कक्षीरं, स्नुहीक्षीरम् । ‘त्रिकटुकं’ प्रसिद्धम्, ‘हयगन्धा’ अश्वगन्धा, ‘सद्मभवधूमैः’ गृहधूमैः । इत्यादिद्वयैः ‘आलिप्य’ तत्पत्रमालिप्य । ‘ललाटस्थं’ भालस्थम् । केषाम् ? ‘गृहिणां’ गृहीतपुरुषाणाम् । ‘कुरुते’ करोति । कम् ? ‘गृहावेशम्’ गृहावतारम् ॥

कुनटीगन्धकतालकचूर्णं कृत्वा सितार्कतूलेन ।

संवेष्ट्य पद्मनालकसूत्रेण च वर्तिरिह कार्या ॥ २६ ॥

‘कुनटी’ मनःशिला, ‘गन्धकः’ प्रसिद्धः, ‘तालकम्’ गोदन्तचूर्णम्, ‘कृत्वा’ एतेषां द्रव्याणां चूर्णं कृत्वा । ‘सितार्कतूलेन’ श्वेतरविफलोद्भवतूलेन । ‘संवेष्ट्य’ तच्चूर्णं तत्तूलमध्ये सम्यग्वेष्टयित्वा, केवलं तेन ‘पद्मनालकसूत्रेण च’ पद्मनालोद्भवसूत्रेण परिवेष्ट्य च । ‘वर्तिरिह कार्या’ अनेन प्रकारेण वर्तिरिह वर्तय्या ॥

सा कङ्कुतैलभाव्या तथा प्रदीपं विबोधयेन्मन्त्री ।

यत्राधोमुखमगमदीपस्तत्रास्ति वसुराशिः ॥ २७ ॥

‘सा कङ्कुतैलभाव्या’ सा कृता वर्तिः कङ्कुतैलेन भावनीया । ‘तथा’ एवंविधवर्त्या । ‘प्रदीपं’ प्रकाशित-दीपम् । ‘विबोधयेत्’ प्रज्वालयेत् । कः ? ‘मन्त्री’ मन्त्रवादी । ‘यत्राधोमुखमगमदीपः’ तत्र यस्मिन् स्थले तदीपः अधोमुखं गच्छति ‘तत्रास्ति वसुराशिः’ तस्मिन् स्थले सुवर्णराशिरस्तीति ज्ञातव्यम् ॥

विनयादिप्रज्वलितज्योतिर्दिशायां मरुन्नभोऽन्तपदम् ।

प्रपठन् मनसा मन्त्रं प्रदीपमालोकयेन्मन्त्री ॥ २८ ॥

‘विनयादि’ उकारपूर्वम् ‘प्रज्वलितज्योतिर्दिशायाम्’ इति पदम् । पुनः कथम्भूतम् ? ‘मरुन्नभोऽन्तपदम्’ स्वाहाशब्दान्वितम् । ‘प्रपठन् मनसा मन्त्रं’ एवं विशिष्टमन्त्रं मानसेनोच्चारयन् । ‘प्रदीपं’ प्रकृतं दीपम् । ‘आलोकयेत्’ विलोकयेत् । कः ? ‘मन्त्री’ मन्त्रवादी ॥

मन्त्रोद्धारः—ॐ १ ज्वलितज्योतिर्दिशायां स्वाहा । इयं दीपवर्तिः अश्वखुरे द्युरिकायां वा प्रतिबोध्य संस्थाप्यावलोकनीया ॥

प्रायोर्वीशनदीनवग्रहनगव्याधिप्रसूनाक्षरा-

ण्येकीकृत्य नखान्वितं त्रिगुणितं तिथ्या पुनर्भाजितम् ।

ब्रूयादुद्धरिताच्छुभाशुभफलं वैषम्यसाम्ये सुधी-

रेतत् तथ्यमिहोदितं मुनिवैर्भव्याब्जघर्माशुभिः ॥ २९ ॥

‘प्राय’ बालयुववृद्धेति त्रिविधप्रायमध्ये नामैकम्, ‘उर्वीश’ सार्वभौमानां राज्ञां मध्ये नामैकं, ‘नदी’ गङ्गादिमहानदीनां मध्ये नामैकं, ‘नवग्रह’ आदित्यादिनवग्रहाणां मध्ये नामैकम्, ‘नग’ मन्दरादिपर्वतानां मध्ये नामैकं, ‘व्याधि’ वातपित्तश्लेष्मोद्भवानां मध्ये नामैकं, ‘प्रसून’ मल्लिकाजातिशतपत्रादिपुष्पाणां मध्ये नामैकम्, ‘अक्षराणि’ प्रायादिप्रसूनान्तानां प्रश्नकथिताक्षरसंख्याम् । ‘एकीकृत्य’ तानि सर्वाण्यप्येकत्राङ्कं कृत्वा । ‘नखान्वितं’ तदङ्कराशिमध्ये विंशत्यङ्कं योजयित्वा । ‘त्रिगुणितं’ तत् सप्तराशिं त्रिभिर्गुणितं कृत्वा, ‘तिथ्या पुनर्भाजितम्’ पुनः पश्चात् त्रिगुणितराशिं पञ्चदशभिः संख्यैर्विभज्य । ‘ब्रूयात्’ कथयेत् । कस्मात् । ‘उद्धरितात्’ भागावशेषात् । किं ? ‘शुभाशुभफलं’ शुभफलमशुभफलं च । कस्मिन् ? ‘वैषम्यसाम्ये’ विषमाङ्के शुभफलं ब्रूयात्, समाङ्के विरुद्धफलं ब्रूयात् । कः ? ‘सुधीः’ धीमान् । ‘एतत् तथ्यं’ एतत् प्रश्ननिमित्तं निश्चितं सत्यम् । ‘इह’ अस्मिन् कल्पे । ‘उदितं’ प्रतिपादितम् । कैः ? मुनिवरैः मुनिवृषभैः । कथम्भूतैः ? भव्याब्जघर्माशुभिः भव्या एव अब्जानि तेषां घर्माशुरादित्यस्तद्वृत्तैर्मुनिभिः । इति प्रश्नः ॥

अर्द्धेन्दुरेखाग्रगतं त्रिशूलं मध्ये च सम्यक्प्रविलिख्य धीमान् ।

ऋक्षेऽमवास्याप्रतिपदिने तु यस्मिन् मृगाङ्को व्यवतिष्ठतेऽसौ ॥ ३० ॥

‘अर्द्धेन्दुरेखाग्रगतम्’ अर्द्धचन्द्राकाररेखाग्रस्थितम् । किं तत् ? ‘त्रिशूलम्’ त्रिशूलाकारम्, न केवलचन्द्राकाराग्रगतं त्रिशूलम् । ‘मध्ये च’ तदर्धचन्द्राकाररेखामध्येऽपि च त्रिशूलम् । ‘सम्यक्प्रविलिख्य’ शोभनं प्रकर्षेण लिखित्वा । कः ? ‘धीमान्’ बुद्धिमान् । ‘ऋक्षे’ नक्षत्रे । ‘अमवास्याप्रतिपदिने तु’ अमावास्यानिवर्तमानप्रतिपदिने तु । ‘यस्मिन् मृगाङ्कः’ असौ चन्द्रमाः प्रतिपदिने यस्मिन् ऋक्षे ‘व्यवतिष्ठते’ सन्तिष्ठते ॥

कृत्वा तदादिं विगणय्य युद्धे विन्द्यात् त्रिशूलाग्रगतेषु मृत्युम् ।

मार्तण्डसंख्येषु जयं च तेषु पराजयं षट्सु बहिःस्थितेषु ॥ ३१ ॥

‘कृत्वा तदादिं’ तत्प्रतिपदिने यस्मिन् नक्षत्रे मृगाङ्कस्तिष्ठति तं नक्षत्रं त्रिशूलरेखाग्रे संस्थाप्य तन्नक्षत्रमादि कृत्वा । ‘विगणय्य’, कः ? ‘युद्धे’, यस्मिन् दिने युद्धे यस्य युध्यमानस्य पुरुषस्य जन्मनक्षत्रं यत्र लभ्यते तत्पर्यन्तं गणयेत् । ‘त्रिशूलाग्रगतेषु मृत्युम्’ जन्मनक्षत्रं त्रिशूलाग्रगतं यदा भवति तदा मृत्युम् । ‘विन्द्यात्’ जानीयात् । ‘मार्तण्डसंख्येषु जयं च तेषु’ अर्द्धचन्द्राकाररेखाभ्यन्तरगतद्वादशक्षेषु तेषु जयं स्यात् । ‘पराजयं षट्सु बहिःस्थितेषु’ अर्धचन्द्राकाररेखाबहिःस्थितेषु षडक्षेषु पराजयः स्यात् ॥

॥ इति युद्धप्रकरणेऽर्द्धेन्दुरेखाचक्रम् ॥

दिशि विदिशि तदुभयान्तरवर्तिभ्यां दिशतु पृच्छके मन्त्री ।

क्रमशो बालं बालां नपुंसकं पूर्णगर्भिण्याः ॥ ३२ ॥

‘दिशि विदिशि’ दिशासु विदिशासु । ‘तदुभयान्तरवर्तिभ्यां’ तदुभयपार्श्ववर्तिभ्यां तद्दिग्विदिग्भ्यां उभयपार्श्वस्थितानाम् । ‘दिशतु’ कथयतु । ‘पृच्छके’ प्रश्नकारिपुरुषे । कः ? ‘मन्त्री’ मन्त्रवादी । कथम् ? ‘क्रमशः’ यथाक्रमम् । ‘बालं बालां नपुंसकम्’ दिशि पृच्छके बालं, विदिशि पृच्छके कुमारीं दिशतु, तद्दिग्विदिग्भ्यां मध्ये वर्तिनि पृच्छके नपुंसकं दिशतु । कस्याः ? ‘पूर्णगर्भिण्याः’ सम्पूर्णगर्भिण्याः ॥

वर्णमात्राश्च दम्पत्योरेकीकृत्य त्रिभाजिताः ।

शून्येनैकेन मृत्युंसो नार्या द्व्यङ्केन निर्दिशेत् ॥ ३३ ॥

‘वर्णमात्राश्च’ वर्णाः ककारादिहकारपर्यन्ताः, मात्राश्च अकारादिषोडशस्वराः । कयोः ? ‘दम्पत्योः’ स्त्रीपुंसोः । ‘एकीकृत्य’ तयोर्नामवर्णमात्राश्च पृथक्पृथक् विश्लेष्य ताः सर्वा एकस्थाने कृत्वा । ‘त्रिभाजिताः’ तां राशिं त्र्यङ्केन विभाजिताः । ‘शून्येनैकेन’ तद्भागोद्धरितशून्येन एकेन च । ‘मृत्युंसः’ पुरुषस्य मृत्युः । ‘नार्या द्व्यङ्केन’ तदुद्धरितद्व्यङ्केन नार्या मृत्युम् । ‘निर्दिशेत्’ कथयेत् ॥

इत्युभयभाषाकविशेखरश्रीमल्लिषेणसूरिविरचिते

भैरवपद्मावतीकल्पे निमित्ताधिकारः

अष्टमः परिच्छेदः ॥ ८ ॥

नवमः रूयादिवश्यौषधपरिच्छेदः । ९

लवंगं कुङ्कुमोसीरं नागकेसरराजिकाः ।

एलामनःशिलाकुष्ठं तगरोत्पलरोचनाः ॥ १ ॥

‘लवङ्गं’ देवकुसुमम् । ‘कुङ्कुमम्’ वाल्हीकम् । ‘उसीरं’ श्वेतवालकम् । ‘नागकेसरं’ चाम्पेयम् । ‘राजिकाः’ श्वेतसर्षपाः । ‘एला’ पृथ्वीका । ‘मनःशिला’ कुनटी । ‘कुष्ठम्’ वाप्यम् । ‘तगरं’ पिण्डीतगरम् । ‘उत्पलं’ श्वेतकमलम् । ‘रोचना’ पिङ्गला ॥

श्रीखण्डतुलसीपिव्वी पद्मकं कुटजान्वितम् ।
सर्वं समानमादाय नक्षत्रे पुष्यनामनि ॥ २ ॥

‘श्रीखण्डं’ माखाश्रयम् । ‘तुलसी’ सरसा । ‘पिव्वी’ गन्धद्रव्यम् । ‘पद्मकं’ प्रसिद्धम् । ‘कुटजान्वितं’ इन्द्रयवान्वितम् । ‘सर्वं समानमादाय’ एतत् सर्वं समानभागं गृहीत्वा । ‘नक्षत्रे पुष्यनामनि’ पुष्यनाम्नि नक्षत्रे ॥

कन्यया पेषयेत् सर्वं हिमभूतेन वारिणा ।
कुरु चन्द्रोदये जाते तिलकं जनमोहनम् ॥ ३ ॥

‘कन्यया’ कुमार्या । ‘पेषयेत्’ सञ्चूर्णयेत् । ‘सर्वं’ तत् सर्वमौषधम् । केन ? ‘हिमभूतेन वारिणा’ हिमाज्जनितोदकेन । ‘कुरु’ । कस्मिन् ? ‘चन्द्रोदये जाते’, अमृतोदये जाते । किं ? ‘तिलकम्’ विशेषकम् । कथम्भूतम् ? ‘जनमोहनम्’ जनवश्यकम् ॥

बर्हिशिखासितगुञ्जागोरम्भाभानुकीटकस्य मलम् ।
निजपञ्चमलोपेतं चूर्णं वनितां वशीकुरुते ॥ ४ ॥

‘बर्हिशिखा’ मयूरशिखा, ‘सितगुञ्जा’ श्वेतगुञ्जा ‘गोरम्भा’ प्रसिद्धा । ‘भानुकीटकस्य मलं’, अर्कपत्रकीटकविद् । ‘निजपञ्चमलोपेतं’ स्वकीयपञ्चमलोपेतम् । ‘चूर्णं’ एतद् द्रव्यान्वितं ताम्बूलचूर्णम् । ‘वनितां’ स्त्रियम् । ‘वशीकुरुते’ वशीकरोति ॥

करवीरभुजङ्गाक्षीजारीदण्डीन्द्रवारुणी—।

गोबन्धिनीसलज्जानां विधाय वटिका बहूः ॥ ५ ॥

‘करवीर’ रक्ताश्वमारजटा, ‘भुजङ्गाक्षी’ सर्पाक्षीजटा, ‘जारी’ पुत्रंजारी, ‘दण्डी’ ब्रह्मदण्डीजटा, ‘इन्द्र-वारुणी’ विशालाजटा, ‘गोबन्धिनी’ अधःपुष्पी, प्रियङ्गुरित्येके, ‘सलज्जानां’ समन्ताज्जटान्वितानां एतेषां द्रव्याणां चूर्णं संपेष्य । ‘विधाय वटिका बहूः’ बहूरपि वटिकाः कृत्वा ॥

१ सर्षपाः इति ग पाठः । २ पिङ्गा इति ग पाठः ३ सुरभा इति ग पाठः

वटिकाभिः समं क्षिप्त्वा लवणं शुभभाजने ।

पक्त्वा स्वमूत्रतो दद्यात् खाद्ये स्त्रीजनमोहनम् ॥ ६ ॥

‘वटिकाभिः समं क्षिप्त्वा’ प्रकृतवटिकाभिः समं क्षिप्त्वा क्षेपयित्वा । किम् ? ‘लवणम्’ समुद्रलवणम् । क्व ? ‘शुभभाजने’ मनोज्ञभाण्डे । ‘पक्त्वा’ पाकं कृत्वा । कथम् ? ‘स्वमूत्रतः’ निजमूत्रतः । ‘दद्यात् खाद्ये’ अन्नादिषु दद्यात् । ‘स्त्रीजनमोहनं’ वनिताजनमोहनं स्यात् ॥

मृतभुजगवदनमध्ये लज्जरिकां सन्निधाय सितगुञ्जाम् ।

रुद्रजटासम्मिश्रामाकृष्य दिनत्रयं यावत् ॥ ७ ॥

‘मृतभुजगवदनमध्ये’ पञ्चत्वप्राप्तकृष्णसर्पास्यमध्ये । ‘लज्जरिकां’ समङ्गामूलम् । ‘सन्निधाय’ सम्यग्निधाय । ‘सितगुञ्जां’ श्वेतरक्तिकाम् । किंविशिष्टम् ? ‘रुद्रजटासम्मिश्राम्’ रुद्रजटासंयुक्ताम् । ‘आकृष्य दिनत्रयं यावत्’ एतन्मूलत्रयं तत्सर्पास्ये दिनत्रयं यावत् संस्थाप्य, पश्चात् ‘आकृष्य’ निष्कास्य ॥

लाङ्गलिकायाः कन्दे गोमयलिप्ते परिक्षिपेच्चूर्णम् ।

परिभाव्य शुनीपयसा स्वमलैः पञ्चाङ्गसम्भूतैः ॥ ८ ॥

‘लाङ्गलिकायाः कन्दे’ कलिहार्याः कन्दं उत्कीर्य तद्द्वयसम्पुटमध्ये । कथम्भूते ? ‘गोमयलिप्ते’ गोशकृता परिलिप्य । ‘परिक्षिपेच्चूर्णम्’ प्राकृतितौषधत्रयकृतचूर्णं तत्कन्दमध्ये निक्षिपेत् । किं कृत्वा ? ‘परिभाव्य’ तच्चूर्णं सम्यग्भाषयित्वा । केन ? ‘शुनीपयसा’ कृष्णशुनीदुग्धेन, न केवलं शुनीदुग्धेन भाव्यम् । ‘स्वमलैः पञ्चाङ्गसम्भूतैः’ स्वकीयपञ्चाङ्गजनितमलैरपि भावयित्वा ॥

नेत्रश्रोत्रमलं शुक्रं दन्तजिह्वामलं तथा ।

वश्यकर्मणि मन्त्रज्ञैः पञ्चाङ्गमलमुच्यते ॥ ९ ॥

‘नेत्रं’ लोचनम्, ‘श्रोत्रं’ श्रवणम्, तयोर्मलम् । ‘शुक्रं’ बीजम् । ‘दन्तः’ रदनः, ‘जिह्वा’ रसना ‘मलं’ अनयोर्मलम् । ‘तथा’ तेन प्रकारेण । ‘वश्यकर्मणि’ स्त्रीवश्यकर्मकरणे । ‘मन्त्रज्ञैः’ मन्त्रविद्भिः । ‘पञ्चाङ्गमलमुच्यते’ एवं पञ्चाङ्गमलमिति कथ्यते ॥

पक्त्वा चूर्णमिदं पश्चाज्जगद्वश्यकरं परम् ।

दद्यात् खाद्यान्नपानेषु स्त्रीपुंसोश्च परस्परम् ॥ १० ॥

‘पक्त्वा’ पाकं कृत्वा । ‘चूर्णमिदम्’ एतत्कथितचूर्णम् । ‘पश्चात्’ तदनन्तरम् । ‘जगद्वश्यकरं’ सकलजन-वश्यकरम् । ‘परं’ अतिशयेन । ‘दद्यात्’ ददातु । केषु ? ‘खाद्यान्नपानेषु’ खादनपानेषु । कयोः ? ‘स्त्रीपुंसोश्च’ स्त्रीपुरुषयोः । कथम् ? ‘परस्परं’ एकैकं तद्दद्यात् वशीभवति ॥

पञ्चपयस्तरूपयसा पोतक्यण्डकरसेन परिभाव्या ।

तिलतैलदीपवर्तिस्त्रिभुवनजनमोहकृद्भवति ॥ ११ ॥

‘पञ्चपयस्तरूपयसा’ न्यग्रोध-उदुम्बर-अश्वत्थ-प्लक्ष-वटी, वटस्थाने बंदुलमिति वदन्ति केचित्, इति पञ्चक्षीरवृक्षक्षीरैः । न केवलं पञ्चक्षीरवृक्षक्षीरैरेव ‘पोतवयण्डकरसेन’ कृष्णमन्थेलिकारसेन । ‘परिभाष्या’ पञ्चसूत्रवर्तिः परिभाष्या, अर्कतूलाब्जसूत्रसात्मलीतूलपट्टकपासा इति पञ्चसूत्रकृता । ‘तिलतैलक्षीपवर्तिः’ । ‘त्रिभुवन-जनमोहकृद् भवति’ भुवनत्रयस्थितजनानां मोहकारिणी भवति ॥

विषमुष्टिकनकहलिनीपिशाचिकाचूर्णमम्बु देहभवम् ।

उन्मत्तकभाण्डगतं क्रमुकफलं तद्वशं कुरुते ॥ १२ ॥

‘विषमुष्टिः’ विषडोडिका । ‘कनकम्’ कृष्णधत्तूरः ‘हलिनी’ कलिहलिनी ‘पिशाचिका’ कपिकच्छुका, ‘चूर्ण’ एतेषां चतुर्द्रव्याणां चूर्णम् । ‘अम्बु देहभवम्’ स्वमूत्रम् । ‘उन्मत्तकभाण्डगतं’ एतद्द्रव्याणां चूर्णं स्वमूत्रसहितं कृष्णधत्तूरकफलभाण्डमध्ये दिनत्रयस्थितं । ‘क्रमुकफलं’ पूगीफलम् । ‘तद्वशं कुरुते’ तत्क्रमुकफलं खादने दत्ते स्त्रीवशं करोति ॥

क्रमुकफलं मुखनिहितं तस्मादिवसत्रयेण संगृह्य ।

कनकविषमुष्टिहलिनीचूर्णैः प्रत्येकं संक्षिप्त्वा(प्य) ॥ १३ ॥

‘क्रमुकफलं’ पूगीफलम् । ‘मुखनिहितं’ सर्पास्ये स्थापितम् । ‘तस्मात्’ सर्पमुखात् । ‘दिवसत्रयेण संगृह्य’ तत्क्रमुकफलं दिनत्रयानन्तरं गृहीत्वा । ‘कनकविषमुष्टिहलिनीचूर्णैः’ धत्तूरकमूलचूर्णम्, विषडोडिकाचूर्णं, हलिनी-चूर्णम्, ‘प्रत्येकं’ पृथक्पृथक् ‘संक्षिप्त्वा(प्य)’ निक्षिप्य ॥

खरतुरगशुनीक्षीरैः क्रमशः परिभाष्य योजयेत् खाद्ये ।

अबलाजनवशकरणं मदनक्रमुकं समुद्दिष्टम् ॥ १४ ॥

‘खरतुरगशुनीक्षीरैः’ रासभाश्वशुनीक्षीरैः । ‘क्रमशः’ परिपाटया । ‘परिभाष्य’ भाष्यं, कनकचूर्णं खरदुग्धेन भाष्यं, विषमुष्टिचूर्णं तुरगदुग्धेन भाष्यं, हलिनीचूर्णं शुनीदुग्धेन भाष्यमिति क्रमेण तत्पूगीफलं दिनत्रयेण भावनीयम्, ‘योजयेत् खाद्ये’ एतत्प्रकारसिद्धं क्रमुकं सकलं ताम्बूले योजनीयम् । ‘अबलाजनवशकरणं मदनक्रमुकं’ स्त्रीजनानां वशीकरणं अनङ्गबाणनामधेयं क्रमुकम् । ‘समुद्दिष्टं’ सम्यक्कथितम् ॥

पुत्तजारीकुङ्कुमशरपुङ्गीमोहनीशमीकुष्टम् ।

गोरोचनाहिकेसरतगररुदन्ती च कर्पूरम् ॥ १५ ॥

‘पुत्तजारी’ प्रसिद्धा, ‘कुङ्कुमं’ काश्मीरम्, ‘शरपुङ्गी’ श्वेतबाणपुङ्गी, ‘मोहनी’ वटपत्रिका, ‘शमी’ केशहन्त्री, ‘कुष्टं’ कोष्ठम् । ‘गोरोचना’ पिङ्गला, ‘अहिकेसरं’ नागकेसरम्, ‘तगरं’ पिण्डीतगरम्, ‘रुदन्ती’ प्रतीता । ‘कर्पूरं’ चन्द्रान्वितम् ॥

कृतवैतेषां चूर्णं यावकमध्ये ततः परिक्षिप्य ।

पङ्कजभवतन्तुवृता वर्तिः कार्या पुनस्तेन ॥ १६ ॥

‘एतेषां प्रागुक्तद्रव्याणां । ‘चूर्णं कृत्वा’ चूर्णं विधाय । ‘यावकमध्ये ततः परिक्षिप्य’ तदनन्तरं तच्चूर्णं अलक्तकपटलमध्ये निक्षिप्य । ‘पङ्कजभवतन्तुवृता’ पद्मनालिकाजनितसूत्रेण वृता । ‘वर्तिः कार्या’ अनेन प्रकारेण वर्तिः कर्तव्या । ‘पुनस्तेन’ पश्चात् तेन वक्ष्यमाणेन ॥

कारुकिकुचभवपयसा त्रिवर्णयोषास्रुतस्तनक्षीरैः ।

परिभाव्य ततः कपिलाघृतेन परिबोधयेद्दीपम् ॥ १७ ॥

‘कारुकिकुचभवपयसा’ पञ्चकारुकीस्तनोद्भवदुग्धेन । ‘त्रिवर्णयोषास्रुतस्तनक्षीरैः’ ततः कारुकीकुचभव-पयसोऽनन्तरं ब्राह्मणक्षत्रियवैश्यस्त्रीणां स्तनदुग्धेन । ‘परिभाव्य’ प्राक्कृतवर्तिः तैर्दुग्धैर्भावयितव्या । ‘ततः’ भावनानन्तरं ‘कपिलाघृतेन’ कपिलाज्येन । ‘परिबोधयेत्’ प्रज्वालयेत् । कम् ? दीपम् ॥

उभयग्रहणे दीपोत्सवे च नवकर्परेऽञ्जनं धार्यम् ।

गोमयविलिप्तभूम्यां स्थित्वा मन्त्राभिषिक्तायाम् ॥ १८ ॥

‘उभयग्रहणे’ सोमसूर्यग्रहणे । ‘दीपोत्सवे च’ अथवा दीपावलीपर्वणि । ‘नवकर्परेऽञ्जनं धार्यम्’ नवीन-मृद्भाण्डकपाले ‘अञ्जनं धार्यम्’ कज्जलं ग्राह्यम् । ‘गोमयविलिप्तभूम्यां’ भूम्यपतितगोमयेन सम्मार्जितपृथिव्याम् । ‘स्थित्वा’ उपित्वा । कथम्भूतायाम् ? ‘मन्त्राभिषिक्त्यां’ वक्ष्यमाणमन्त्रेणाऽभिषिक्तभूम्याम् ॥

मन्त्रोद्धारः—ॐ भूर्भूमिदेवते ! तिष्ठ तिष्ठ ठः ठः ॥ भूमिसंमार्जनमन्त्रः ॥ २

ॐ नमो भगवते चन्द्रप्रभाय चन्द्रेन्द्रमहिताय नयनमनोहराय हरिणि हरिणि सर्वे वश्यं कुरु कुरु स्वाहा ॥

कज्जलोद्धारणमन्त्रः ॥

ॐ नमो रेभूताय समाहिताय कामाय रामाय ॐ चुलुचुलु गुलुगुलु नीलभ्रमरि नीलभ्रमरि मनोहरि नमः ॥

नयनाञ्जनमन्त्रः ॥

कज्जलरञ्जितनयने दृष्ट्वा तां वाञ्छतीह मदनोऽपि ।

नरमप्यञ्जितनयनं भूपाद्यास्तस्य यान्ति वशम् ॥ १९ ॥

‘कज्जलरञ्जितनयने’ कज्जलेनाञ्जिते नेत्रे । ‘दृष्ट्वा’ विलोक्य । ‘तां’ कामिनीं ‘वाञ्छतीह मदनोऽपि’ कामदेवोऽपि वशं याति । ‘नरमप्यञ्जितनयनं’ पुरुषमप्यञ्जितनयनं दृष्ट्वा । ‘भूपाद्याः तस्य यान्ति वशं’ तस्य कज्जलाञ्जितपुरुषस्य क्षत्रियाद्यास्तदञ्जनाद्वश्या भवन्ति ॥

विषमुष्टिकनकमूलं रालाक्षतवारिणा ततः पिष्टम् ।

तद्रसभावितपत्रं पिशाचयत्युदरमध्यगतम् ॥ २० ॥

१ ०दीपः इति ख पाठः ।

२ ‘ॐ ऐंद्रदेवते ! कज्जलं गृह्ण गृह्ण स्वाहा’ कर्पराभिमन्त्रणं । इति ख ग पाठः ।

३ भूतेशाय इति ख पाठः । ४ वशयतीति मदनोपि इति ग पाठः

५ नरमप्यञ्जितनेत्रं भूपाद्या यान्ति तस्य वशम् इति ग पाठः

‘विषमुष्टिः’ विषडोडिका । ‘कनकमूलं’ धत्तूरमूलम् । ‘रालाक्षतवारिणा’ रालाक्षतधौतोदकेन । ‘ततः पिष्टम्’ तस्मात् पिष्टम् । ‘तद्रसभावितपत्रं’ तत्पिष्टौषधरसेन भावितं ताम्बूलपत्रम् । ‘पिशाचयति’ पिशाच इवाचरति । ‘उदरमध्यगतं’ जठरमध्यं गते सति पुरुषं पिशाचयति ॥

चिक्कणिकेप्सितरूपापिशाचिकासार्द्रचितमधीमथिते ।

नृकपाले मातृगृहे काननकार्पासकृतवर्त्या ॥ २१ ॥

‘चिक्कणिका’ इलोठा, कर्णाटभाषायां उहाठा । ‘ईप्सितरूपा’ बहुरूपा, सरटविट् । ‘पिशाचिका’ कपिकच्छुका । ‘सार्द्रचितमधीमथिते’ सार्द्रचितोद्भवमध्या निर्माथिते । कस्मिन् ? ‘नृकपाले’ नरकपाले । ‘मातृगृहे’ सप्तमातृकाणां गृहे । ‘काननकार्पासकृतवर्त्या’ अरण्योद्भवकार्पासतूलेन निर्मितवर्त्या ॥

धार्यं कृष्णाष्टम्यामञ्जनमेतन्महाघृतोद्भूतम् ।

तेन त्रिशूलमञ्जनमपि कुर्यादङ्कभीत्यर्थम् ॥ २२ ॥

‘धार्यम्’ धर्तव्यम् । ‘कृष्णाष्टम्यां’ कृष्णाष्टम्यां कृष्णचतुर्दश्यां वा । किम् ? ‘अञ्जनं’ कज्जलम् । ‘एतत्’ एतत्कज्जलम् । ‘महाघृतोद्भूतम्’ महाघृतोद्भवम् । ‘तेन त्रिशूलं कुर्यात्’ अनेन प्रकारेण कृतकज्जलेन न केवलं त्रिशूलं कुर्यात् । ‘अञ्जनमपि कुर्यात्’ नयनाञ्जनमपि करोतु । किमर्थम् ? ‘अङ्कभीत्यर्थम्’ एतदञ्जनं प्रतिपक्षकस्य भयोत्पादनार्थम् ॥

तत्कज्जलोद्धारमन्त्रः—ॐ नमो भगवति ! हिडिम्बवासिनि ! अल्ललांसापिपये ! नहयलमंडलपइद्रिए तुह रणमत्ते पहरणदुद्रे आयासमंडि ! पायालमंडि सिद्धमंडि जोइणिमंडि सव्वमुहमंडि कज्जलं पडउ^१ स्नाहा ॥ प्राकृतमन्त्रः ॥ कज्जलपातनं ऐशान्यभिमुखेन कर्तव्यम् ॥

चितवह्निदग्धभूतद्रुमयमशाखामधीं समाहृत्य ।

अंकोल्लतैलसूतककृष्णबिडालीजरायुश्च ॥ २३ ॥

‘चितवह्निदग्धभूतद्रुमयमशाखामधीं’ चिताग्निज्वलितकलिद्रुमदक्षिणदिग्भवशाखाजनितमधीम् । ‘समाहृत्य’ सम्यगाहृत्य । ‘अंकोल्लतैलं’ अंकोल्लबीजोद्भवतैलं । ‘सूतकम्’ पारदरसम् । ‘कृष्णबिडालीजरायुश्च’ कृष्णमार्जारी-जरायुमपि ॥

घूकनयनाम्बुमर्दितगुलिकां कृत्वा त्रिलोहसम्मठिताम् ।

धृत्वा तामात्ममुखे पुरुषोऽदृश्यत्वमायाति ॥ २४ ॥

‘घूकनयनाम्बुमर्दितगुलिकां कृत्वा’ उलूकनेत्राम्बुमर्दितभूतद्रुमोद्भवमध्यादिचतुर्द्रव्याणां गुटिकां कृत्वा । ‘त्रिलोहसम्मठितां’ ताम्रतारसुवर्णाख्यैः अर्कषोडशवह्निभिरिति भागकृतत्रिलोहेन सम्यग्मठितां कृत्वा । ‘धृत्वा तामात्ममुखे’ तां त्रिलोहमठितां गुलिकां स्वमुखे धारयित्वा । ‘पुरुषः’ पुमान् । ‘अदृश्यत्वम्’ अदृश्यभावम् । ‘आयाति’ आगच्छति ॥

सितशरपुंखामूलं धृत्वा सितकोकिलाक्षबीजं च ।
वनवसलारसपिष्टं वीर्यस्तम्भं मुखे संस्थम् ॥ २५ ॥

‘सितशरपुंखामूलं’ श्वेतबाणपुंखामूलम् । ‘धृत्वा’ गृहीत्वा । ‘सितकोकिलाक्षबीजं च’ श्वेतकोकिलाक्षबीजानि च । ‘वनवसलारसपिष्टम्’ अरण्योद्भव (उ) पोदकीरसेन पेषितं वनवला इति, कर्णाटभाषायां कासलि । ‘वीर्यस्तम्भं’ शुक्रस्तम्भम् । ‘मुखे संस्थं’ पुरुषमुखे संस्थम् ॥

कृष्णवृषदंशदक्षिणजङ्घायाः शल्यखण्डमादाय ।
बद्धं कटिप्रदेशे वीर्यस्तम्भं नृणां कुरुते ॥ २६ ॥

‘कृष्णवृषदंशदक्षिणजङ्घायाः’ कृष्णबिडालदक्षिणजङ्घायाः । ‘शल्यखण्डं’ तदस्थिखण्डम् । ‘आदाय’ गृहीत्वा । ‘बद्धं कटिप्रदेशे’ पुंसः कटिप्रदेशे बद्धम् । ‘नृणां’ मनुष्याणाम् । वीर्यस्तम्भं ‘कुरुते’ करोति ॥

कपिलाघृतेन बोधितदीपः सुरगोपचूर्णसम्मिलितः ।
स्तम्भयति पुरुषवीर्यं रत्यारम्भे निशासमये ॥ २७ ॥

‘कपिलाघृतेन’ कपिलाज्येन । ‘बोधितदीपः’ प्रज्वलितदीपः । कथम्भूतः ? ‘सुरगोपचूर्णसम्मिलितः’ इन्द्र-गोपचूर्णगर्भकृतवर्त्यान्वितः । स दीपः किं करोतीत्याह ‘स्तम्भयति’ स्तम्भं करोति । किम् ? ‘पुरुषवीर्यम्’ नृवीर्यम् । कस्मिन् ? ‘रत्यारम्भे’ सुरतप्रारम्भे । क्व ? ‘निशासमये’ रात्रिसमये ॥

टङ्कणपिप्पलिकामासूरणकर्पूरमातुलिङ्गरसैः ।
कृत्वात्माङ्गुलिलेपं कुरुते स्त्रीणां भगद्रावम् ॥ २८ ॥

‘टङ्कणं’ मालतीतटसम्भवम् । ‘पिप्पलिकामा’ महाराष्ट्री । ‘सूरण’ अरण्यश्वेतसूरणकन्दः । ‘कर्पूरः’ चन्द्रः । ‘मातुलिङ्गं’ बीजपूरम् । तेषां रसैः । ‘कृत्वा’ । कम् ? ‘आत्माङ्गुलिलेपं’ स्वाङ्गुलिलेपम् । ‘स्त्रीणां’ वनितानाम् । ‘भगद्रावम्’ भगनिर्झरणं कुरुते ॥

मूलं श्वेतापमार्गस्य कुबेरदिशि संस्थितम् ।
उत्तरात्रितयं ग्राह्यं शीर्षस्थं द्यूतवादजित् ॥ २९ ॥

‘मूलं श्वेतापमार्गस्य’ श्वेतखरमञ्जर्या मूलम् । कथम्भूतम् ? ‘कुबेरदिशि संस्थितम्’ । ‘उत्तरात्रितये’ उत्तराफाल्गुनी—उत्तराषाढा—उत्तराभाद्रपदेतिश्रद्धक्षत्रये । ‘ग्राह्यं’ गृहीतव्यम् । ‘शीर्षस्थं’ मस्तके स्थितम् । ‘द्यूत-वादजित्’ द्यूते विवादे विजयं करोति ॥

अग्न्यावर्तितनागे हरवीर्यं निक्षिपेत् ततो द्विगुणम् ।
मुनिकनकनागसर्पज्योतिष्मत्यतसिभिश्च तन्मर्द्यम् ॥ ३० ॥

‘अग्न्यावर्तितनागे’ अग्निना वर्तिते नागे । ‘हरवीर्ये’ पारदरसम् । ‘निक्षिपेत् ततो द्विगुणं’ ततः नागैकभागाद्रसं द्विभागं निक्षिपेत् । ‘मुनिः’ रक्तागस्तितः । ‘कनकं’ कृष्णधत्तूरं । ‘नागसर्पः’ नागदमनकं । ‘ज्योतिष्मत्यतसिभिश्च’ कंगुण्यतसीभ्यां च । ‘तन्मर्थम्’ तत्पूर्वोक्तनागमेतेषां रसैर्मर्दनीयम् ॥

डीकेन मर्दयित्वा गणियार्या मदनवल्यकं कृत्वा ।

रतिसमये वनितानां रतिदर्पविनाशनं कुर्यात् ॥ ३१ ॥

‘डीकेन’ निर्यासेन । ‘मर्दयित्वा’ पुनरपि मर्दनं कृत्वा । कस्याः डीकेन ? ‘गणियार्याः’ कर्णिकारवृक्षस्य । ‘मदनवल्यकं कृत्वा’ स्मरवल्यं लिङ्गे कृत्वा । ‘रतिसमये’ सुरतकाले । ‘वनितानां’ स्त्रीणाम् । ‘रतिदर्पविनाशनं’ सुरतगर्वविनाशनम् । ‘कुर्यात्’ करोति ॥

व्याघ्रीबृहतीफलरससूरणकण्डूतिचणकपत्राम्बु ।

कपिकच्छुवज्रवल्लीपिप्पलिकामाम्लिकाचूर्णम् ॥ ३२ ॥

‘व्याघ्रीबृहतीफलरसं’ बृहतीद्वयफलरसं । ‘सूरणं’ श्वेतसूरणं । ‘कण्डूतिः’ अम्रिकः । ‘चणकपत्राम्बु’ भार्द्रचणकपत्राम्बु । ‘कपिकच्छुः’ पिशाचिका । ‘वज्रवल्ली’ काण्डवल्ली । ‘पिप्पलिकामा’ महाराष्ट्री । ‘अम्लिका’ चाङ्गेरी । ‘चूर्णं’ केषाञ्चिद्रसः ॥

अग्न्यावर्तितनागं नववारं भावयेदिमैर्द्रव्यैः ।

स्मरवल्यं कृत्वैवं वनितानां द्रावणं कुरुते ॥ ३३ ॥

‘अग्न्यावर्तितनागं’ । ‘नववारं’ नवसंख्यावारैः । ‘भावयेद्’ भावनां कुर्यात् । कैः ? ‘इमैर्द्रव्यैः’ एतत्कथितद्रव्यैः । ‘स्मरवल्यं कृत्वैवं’ अनेन प्रकारेण मदनवल्यं कृत्वा । ‘वनितानां’ स्त्रीणाम् । ‘द्रावणं’ भगनिर्झरणं । ‘कुरुते’ करोति ॥

भानुस्वरजिनसंख्याप्रमाणसूतकगृहीतदीनारान् ।

अङ्गोल्लराजवृक्षकुमारीरसशोधनं कुर्यात् ॥ ३४ ॥

‘भानुस्वरजिनसंख्या’ द्वादशसङ्ख्या, षोडशसङ्ख्या, चतुर्विंशतिसङ्ख्या । ‘प्रमाणसूतकगृहीतदीनारान्’ एवं त्रिसङ्ख्याकथितप्रमाणपारदरसगृहीतगद्याणकान् । ‘अङ्गोल्लराजवृक्षकुमारीरसशोधनं कुर्यात्’ ‘अङ्गोल्लरसः’ सम्पाकरसः । ‘राजवृक्षरसः’ । ‘कुमारीरसः’ गृहकन्यारसः । एतैः रसैः पारदसंशोधनं कुर्यात् ॥

शशिरेखाखरकर्णीकोकिलनयनापमार्गकनकानाम् ।

चूर्णैः सहैकविंशतिदिनानि परिमर्दयेत् सूतम् ॥ ३५ ॥

‘शशिरेखा’ वाकुचीबीजं । ‘खरकर्णी’ गर्दभकर्णी, कर्णाटभाषया कर्त्येगिरि । ‘कोकिलनयनं’ कोकिलाक्षिबीजं च । ‘अपामार्गः’ प्रत्येकपुष्पीबीजम् । ‘कनकं’ कृष्णधत्तूरकम् । ‘चूर्णैः सहैकविंशतिदिनानि’ एभिः चूर्णैः सह प्रत्येकं एकविंशतिदिनानि । ‘परिमर्दयेत् सूतं’ शोधितपारदरसं मर्दयेत् ॥

निशायां काञ्जिकाधूपं दत्त्वा योनौ प्रवेशयेत् ।

बालां मध्यां गतप्रायां योषां विज्ञाय तत्कृत्वा ३६ ॥

‘निशायां’ रात्रौ । ‘काञ्जिकाधूपं दत्त्वा’ आरनलिनधूपं दत्त्वा । ‘योनौ प्रवेशयेत्’ तद्भूपितरसं स्त्रीयोनौ प्रवेशयेत् । ‘बालां मध्यां गतप्रायां योषां विज्ञाय तत्कृत्वा’ बालस्त्रीणां द्वादशगद्याणप्रमाणरसकृतजलूका मध्य-प्रमाणस्त्रीणां षोडशगद्याणप्रमाणरसकृतजलूका गतप्रायस्त्रीणां चतुर्विंशतिगद्याणप्रमाणरसकृतजलूका इति क्रमं ज्ञात्वा प्रवेशयेत् ।

नीरसतां बिभ्राणां योषां रतिसंगरे मदोन्मत्तां ।

द्रावयति तादृशीमप्येष जलूकाप्रयोगस्तु ॥ ३७ ॥

‘नीरसतां बिभ्राणां’ निर्द्रवभावं धारयन्ती । ‘योषां’ स्त्रियम् । ‘रतिसङ्गरे’ सुरतरणरङ्गे । ‘मदोन्मत्तां’ यौवनमदोन्मत्ताम् । ‘द्रावयति तादृशीमपि’ एवंविधां मदोन्मत्तामपि क्षरयति । ‘एष जलूकाप्रयोगस्तु’ तु-पुनः एषः—कथितप्रकारेण कृतजलूकाप्रयोगः ॥ इति जलूकाप्रयोगविधानम् ॥

सोमाशाश्रितमूलं कपिकच्छोर्गोजलेन परिपिष्टम् ।

निजतिलकप्रतिबिम्बं संपश्यति शाकिनीशीर्षे ॥ ३८ ॥

‘सोमाशाश्रितमूलं’ उत्तरादिगतमूलम् । कस्याः ? ‘कपिकच्छोः’ पिशाच्याः । कथम्भूतं मूलम् ? ‘गो-जलेन परिपिष्टं’ गोमूत्रेण वर्तितम् । ‘निजतिलकप्रतिबिम्बं’ स्वकीयविशेषकं प्रतिरूपम् । ‘सम्पश्यति शाकिनीशीर्षे’ स्वकीयतिलकं शाकिनीललाटे तदेव पश्यति ॥

आदित्याक्षतदिव्यस्तम्भविधौ मरिचपिप्पलीकामाम् ।

दिव्यस्तम्भे सुण्ठीचूर्णं च भक्षयेद् धीमान् ॥ ३९ ॥

‘आदित्याक्षतदिव्यस्तम्भविधौ’ आदित्यतन्दुलदिव्यस्तम्भने । ‘मरिचपिप्पलीकामाम्’ उषणमहाराष्ट्रीचूर्णं भक्षयेत् । कर्पूरदिव्यस्तम्भने तु कपालिकादि कर्पूरादि । ‘दिव्यस्तम्भे’ दिव्यस्तम्भविधाने । ‘सुण्ठीचूर्णं च भक्षयेत्’ महौषधीचूर्णं भक्षयेत् । कः ‘धीमान्’ बुद्धिमान् ॥

लज्जरिकाभेकवसां करलिप्तं स्तम्भनं करोत्यग्नेः ।

श्वासनिरोधेन तुलादिव्यस्तम्भो भवत्येव ॥ ४० ॥

‘लज्जरिका’ लज्जरिकासमंगा । ‘भेकवसा’ हरिवसा । ‘करलिप्तं’ तच्चूर्णानि तद्वसया हस्तलिप्तम् । ‘स्तम्भनं करोत्यग्नेः’ अग्निस्तम्भो भवत्येव । ‘श्वासनिरोधेन तुलादिव्यस्तम्भो भवत्येव’ श्वासनिरोधेन घटे तुलादिव्यस्तम्भोऽवश्यं भवत्येव ॥

निर्गुण्डिका च सिद्धार्था गृहद्वारेऽथवापणे ।

बद्धं पुष्यार्कयोगेन जायते क्रयविक्रयम् ॥ ४१ ॥

‘निर्गुण्डिका’ सितभूतकेशी । ‘सिद्धार्थाः’ श्वेतसर्षपाः । ‘गृहद्वारे’ स्ववेश्मद्वारे । ‘अथवा आपणे’ विपणौ । ‘बद्धं पुष्यार्कयोगेन’ पुष्यनक्षत्रे रविवारेण योगे बद्धं चेत् । ‘जायते क्रयविक्रयं’ वस्तुक्रयविक्रयं भवत्येव ॥

पिबति प्रसूनसमये जपाप्रसूनं विमर्द्य कञ्जिकया ।

न बिभर्ति सा प्रसूनं धृतेऽपि तस्याः न गर्भः स्यात् ॥ ४२ ॥

‘पिबति’ पानं करोति । ‘प्रसूनसमये’ दिनत्रयपुष्पकाले । किम् ? ‘जपाप्रसूनं’ जपाकुसुमम् । किं कृत्वा ? ‘विमर्द्य’ विशेषेण मर्दयित्वा । कया ? ‘कञ्जिकया’ सौवीरेण । ‘सा’ नारी । ‘प्रसूनं’ पुष्पं । ‘न बिभर्ति’ न धारयति । ‘धृतेऽपि’ यदि कथमपि पुष्पं धरति तथापि ‘तस्या न गर्भः स्यात्’ तस्या वनिताया गर्भ-सम्भवो न भवत्येव ॥

इत्युभयभाषाकविशेखरश्रीमल्लिषेणसूरिविरचिते

भैरवपद्मावतीकल्पे वश्यतन्त्राधिकारो नाम

नवमः परिच्छेदः ॥ ९ ॥

संग्रहमङ्गन्यासं रक्षां स्तोभं च वच्यहं स्तम्भम् ।

विषनाशनं सचोद्यं खटिकाफणिदशनदंशं च ॥ १ ॥

‘संग्रहं’ दष्टस्य संग्रहम् । ‘अङ्गन्यासं’ दष्टपुरुषस्य शरीराक्षरविन्यासम् । ‘रक्षां’ दष्टस्य रक्षाकरणम् । ‘स्तोभं च’ दष्टवेशकरणं, चः समुच्चये । ‘वच्यहं’ मल्लिषेणाचार्यः कथयामि । ‘स्तम्भं’ दष्टस्य शरीरे विषप्रसरणनिरोधः स्तम्भम् । ‘विषनाशनं’ निर्विषीकरणम् । ‘सचोद्यं’ चोद्येन सह वर्तत इति सचोद्यं, दष्टपटाच्छादनादि कौतुकम् । ‘खटिकाफणिदशनदंशं च’ खटिकालिखितसर्पदन्तदंशमित्यष्टाङ्गगारुडमहं वच्मीति सम्बन्धः ॥

प्रथमस्तावत्संग्रहोऽभिधीयते—

समविषमाक्षरभाषिणि दूते शशिदिनकरौ च वहमानौ ।

दष्टस्य जीवितव्यं तद्विपरीते मृतिं विन्द्यात् ॥ २ ॥

‘समविषमाक्षरभाषिणि दूते शशिदिनकरौ च वहमानौ’ चन्द्रदिवाकरौ स्वरौ प्रवर्तमानौ । ‘दष्टस्य जीवितव्यं’ समाक्षरभाषिणि दूते चन्द्रे वहमाने, विषमाक्षरभाषिणि दूते सूर्ये वहमाने दष्टपुरुषस्य संग्रहोऽस्तीति विन्द्यात् । ‘दष्टस्य जीवितव्यं तद्विपरीते मृतिं विन्द्यात्’ समाक्षरभाषिणि दूते सूर्ये वहमाने, विषमाक्षरभाषिणि दूते चन्द्रे वहमाने इति स्वरवर्णवैपरीत्ये दष्टपुरुषस्य संग्रहो न विद्यते इति विन्द्यात् ॥

दूतमुखोत्थितवर्णान् द्विगुणीकृत्य त्रिभिर्हरेद्भागम् ।

शून्येनोद्धरितेन च मृतिजीवितमादिशेत् प्राज्ञः ॥ ३ ॥

‘दूतमुखोत्थितवर्णान् द्विगुणीकृत्य’ तानि प्रश्नाक्षराणि सर्वाणि द्विगुणीकृत्य । ‘त्रिभिर्हरेद्भागम्’ तद्द्विगुणितराशिं त्रिभिर्भागैः हरेत् । ‘शून्येनोद्धरितेन च’ तद्भागवशेषशून्येन शून्य समच्छेदेन एकद्विरवशिष्टेन च । ‘मृतजीवितमादिशेत्’ शून्येन दष्टस्य संग्रहाभावमादिशेत्, एकद्विरुद्धरितेन दष्टस्य संग्रहोऽस्तीत्यादिशेत् ॥

हं वं क्षं मन्त्रमन्त्रिततोयेनोद्धुषति यस्य गात्रं चेत् ।

स च जीवत्यथवाक्षिस्पन्दनतो नान्यथा दष्टः ॥ ४ ॥

‘हं वं क्षं मन्त्रः’ हं वं क्षं इति मन्त्रः । ‘मन्त्रिततोयेन’ अनेन मन्त्रेणाभिमन्त्रितोदकेनाच्छोटितेन । ‘उद्धुषति यस्य गात्रं चेत्’ यस्य दष्टस्य शरीरं कम्पवच्चेत् । ‘स च जीवति’ स उद्धुषितगात्रपुरुषो जीवति । ‘अथवाक्षिस्पन्दनतः’ अन्येन प्रकारेणाक्षोरुन्मीलनेन संदष्टो जीवति । ‘नान्यथा दष्टः’ यस्य दष्टस्य तदुदकसिञ्चनेन गात्रोद्धुषणं तदक्षिस्पन्दनं च न विद्यते तस्य दष्टस्य जीवितं न स्यादिति ज्ञातव्यम् ॥

इति संग्रहपरिच्छेदः ।

अतः परमङ्गन्यासोऽभिधीयते—

क्षिप नुँ स्वाहा बीजानि विन्यसेत् पादनाभिहृन्मुखशीर्षे ।

पीतसितकाञ्चनासितसुरचापनिभानि परिपाट्या ॥ ५ ॥

‘क्षिप उँ स्वाहा बीजानि’ क्षिप उँ स्वाहेति पञ्च बीजानि । ‘विन्यसेत्’ विशेषेण स्थापयेत् । केषु ? ‘पादनाभिहृन्मुखशीर्षे’ पादद्वये, नाभौ, हृदये, आस्ये, मस्तके इत्येतेषु पञ्चसु स्थानेषु । कथम्भूतानि बीजानि ? ‘पीतसितकाञ्चनासितसुरचापनिभानि’ पीतं—हरिद्रानिभं, श्वेतं—श्वेतवर्णं, काञ्चनं—सुवर्णवर्णं, असितं—कृष्णवर्णं, सुरचापं—इन्द्रधनुर्वर्णं, निभानि—सदृशानि । एवं पञ्चवर्णबीजानि ‘परिपाठ्या’ ‘क्षि’ बीजं पीतवर्णं पादद्वये, ‘प’ बीजं श्वेतवर्णं नाभौ, उँ बीजं काञ्चनवर्णं हृदि, स्वा इति बीजं कृष्णवर्णं आस्ये, ‘हा’ इति बीजं इन्द्रचापवर्णं मूर्ध्नि, एवं क्रमेण पञ्चसु स्थानेषु विन्यसेत् ॥ इत्यङ्गन्यासक्रमः ॥

अतः परं रक्षाविधानं कथ्यते—

पद्मं चतुर्दलोपेतं भूतान्तं नामसंयुतम् ।

दलेषु शेषभूतानि मायया परिवेष्टितम् ॥ ६ ॥

‘पद्मं’ कमलम् । ‘चतुर्दलोपेतं’ चतुःपत्रयुक्तम् । ‘भूतान्तं’ भूतानि—पृथिव्यप्तेजोवाय्वाकाशसंज्ञानि तेषामन्त आकाशो हकारः, तं हकारं कर्णिकामध्ये । कथम्भूतम् ? ‘नामसंयुतं’ दष्टनामगर्भीकृतम् । ‘दलेषु’ बहिःस्थित-चतुर्दलेषु । ‘शेषभूतानि’ क्षिप उँ स्वाहेति चतुर्वीजानि लिखेत् । ‘मायया परिवेष्टितं’ तत्पद्मोपरि ह्रींकारेण त्रिधा परिवेष्टितं लिखित्वा दष्टस्य गले बध्नीयात् । अथवा चन्दनेन दष्टवक्षःस्थले एतद्यन्त्रं लिखेत् ॥ इति रक्षाविधानम् ॥ इदानीं स्तोभकरणमारभ्यते—

वह्निजलभूमिपवनव्योमाग्रे दहपचद्वयं योज्यम् ।

स्तोभययुगलं स्तोभं मध्यमिकाचालनाद्भवति ॥ ७ ॥

‘वह्निः’ उँकारः । ‘जलं’ पकारः । ‘भूमिः’ क्षिकारः । ‘पवनः’ स्वाकारः । ‘व्योम’ हकारः । ‘अग्रे’ एतेषां पञ्चबीजाक्षराणामग्रे । ‘दहपचद्वयं योज्यम्’ दह दहेति पदद्वयं योज्यं, तदग्रे पच पचेति पदद्वयं योजनीयम् । ‘स्तोभययुगलं’ स्तोभय स्तोभयेति पदद्वयम् । ‘स्तोभं’ अनेन मन्त्रोच्चारणाच्चाटनेन (?) दष्टवेशः । कथम् ? ‘मध्यमिकाचालनात्’ मध्यमाङ्गुल्याश्चालनाद् । ‘भवति’ जायते ॥

मन्त्रोद्धारः—उँ पक्षि स्वाहा दह दह पच पच स्तोभय स्तोभय ॥ इति स्तोभनमन्त्रः ॥

॥ इति स्तोभनविधानम् ॥

इदानीं विषस्तम्भनमुदीर्यते—

आद्यन्ते भूबीजं मध्ये जलवह्निमारुतं योज्यम् ।

स्तम्भययुगलं स्तम्भो वामकराङ्गुष्ठचालनतः ॥ ८ ॥

‘आद्यन्ते भूबीजं’ मन्त्रादौ मन्त्रान्ते पृथ्वीबीजम्—क्षि इति । ‘मध्ये जलवह्निमारुतं योज्यं’ मन्त्रमध्ये प उँ स्वेति बीजत्रयं योजनीयम् । ‘स्तम्भययुगलं’ तदग्रे स्तम्भयेति पदद्वयम् । ‘स्तम्भः’ अनेन कथित-मन्त्रोच्चारणेन विषप्रसरस्तम्भो भवति । कथम् ? ‘वामकराङ्गुष्ठचालनतः’ स्ववामकराङ्गुष्ठचालनेन ।

मन्त्रोद्धारः—क्षिप उँ स्वाक्षि स्तम्भय स्तम्भय ॥ विषस्तम्भनमन्त्रः ॥

इदानीं निर्विषीकरणमभिधीयते—

जलभूमिवह्निमारुतगगनैः संप्लावयद्वयोपेतैः ।

भवति च विषापहारस्तर्जन्याश्चालनादचिरात् ॥ ९ ॥

‘जलं’ पकारः । ‘भूमिः’ क्षिकारः । ‘वन्हिः’ उँकारः । ‘पवनः’ स्वाकारः । ‘गगनं’ हाकारः । इति पञ्च-
बीजाक्षरैः । कथम्भूतैः ? ‘संप्लावयद्वयोपेतैः’ संप्लावय संप्लावयेति पदद्वयान्वितैः । ‘भवति’ स्यादेव । कः ?
‘विषापहारः’ विषनिर्विषीकरणम् । कस्मात् ? ‘तर्जन्याश्चालनात्’ स्ववामकरतर्जन्याश्चालनात् । कथम् ? ‘अचिरात्’
शीघ्रतः । अतः मन्त्रोद्धारः—पक्षि^१ उँ स्वाहा संप्लावय संप्लावय ॥ इति विषापहारः ॥

इदानीमन्यत्रविषसंक्रमणकौतुकमभिधीयते—

मरुदग्निवारिधामव्योमपदं संक्रमव्रजद्वितयम् ।

चालनयाऽनामिकया नितरां विषसंक्रमो भवति ॥ १० ॥

‘मरुत्’ स्वाकारः । ‘अग्निः’ उँकारः । ‘वारि’ पकारः । ‘धाम’ क्षिकारः । ‘व्योम’ हाकारः । ‘संक्रमव्रजद्वितयं’
संक्रम संक्रम व्रज व्रजेति पदद्वयम् । ‘चालनयानामिकया’ स्ववामकरानामिकायाश्चालनेन । ‘नितरां’ अतिशयेन ।
‘विषसंक्रमो भवति’ परं प्रति विषसंक्रमो भवति ॥

स्वा उँ प क्षि हा संक्रम संक्रम व्रज व्रजेति विषसंक्रमणमन्त्रः ॥

नागावेशः—

व्योमजलवह्निपवनक्षितियुतमन्त्राद्भवत्यथावेशः ।

सं क्षि प हः प क्षि प हः पठनेन कनिष्ठिचालनतः ॥ ११ ॥

‘व्योम’ हाकारः । ‘जलं’ पकारः । ‘वन्हिः’ उँकारः । ‘पवनः’ स्वाकारः । ‘क्षितिः’ क्षिकारः । ‘युतमन्त्रात्’
युक्तमन्त्रात् । ‘भवति’ एतत्कथितमन्त्राज्जायते । ‘अथ’ पश्चात् । ‘आवेशः’ पुरुषशरीरे नागावेशः । ‘सं क्षि प हः’
प क्षि प हः इति । ‘पठनेन’ एतन्मन्त्रपठनेन । कस्मात् ? ‘कनिष्ठिचालनतः’ वामकरकनिष्ठिकाचालनात् ॥

मन्त्रोद्धारः—हा प उँ स्वाक्षि सं क्षि प हः प क्षि प हः । इति पदे नागावेशमन्त्रः ॥

कर्णजाप्येन भेरुण्डा निर्विषं कुरुते नरम् ।

विद्या सुवर्णरेखापि दष्टं तोयाभिषेकतः ॥ १२ ॥

‘कर्णजाप्येन’ दष्टपुरुषस्य कर्णजाप्येन । ‘भेरुण्डा’ भेरुण्डदेव्या विद्या । ‘निर्विषं कुरुते’ निर्विषीकरणं कुरुते ।
‘नरं’ दष्टं पुरुषम् । ‘विद्या सुवर्णरेखापि’ अपि—पश्चात् सुवर्णरेखा विद्या । ‘दष्टं’ पुरुषं । ‘तोयाभिषेकतः’
सुवर्णरेखानामविद्ययाऽभिमन्त्रितोदकाभिषेकेण निर्विषं करोति ॥

१ क्षिप उँ स्वाहा स्तंभय स्तंभय निर्विषकरणं पक्षि उँ स्वाहा संप्लावय संप्लावय । अयं विषापहारमन्त्रः
इति ख पाठः ॥

भेरुण्डविद्यामन्त्रोद्धारः—ॐ एकहि एकमाते भेरुण्डा विजाभक्जकरंडे तंतु मंतु आमोसइ हुंकारविष नासइ थावर जंगम कित्तिम अंगज^१ ॐ फट् ॥ इयं कर्णजाप्या भेरुण्डविद्या । प्राकृतमन्त्रः ॥

अतः सुवर्णरेखामन्त्रोद्धारः—ॐ सुवर्णरेखे ! कूटविग्रहरूपिणि ! स्वाहा ॥

इयं तोयाभिषेककरणसुवर्णरेखा विद्या ।

भूजलमरुन्नभोऽक्षरमन्त्रेण घटाम्बु मन्त्रितं कृत्वा ।

पादादिविहितधारानिपातनाद्भवति विषनाशः ॥ १३ ॥

‘भू’ क्षि । ‘जलं’ प । ‘मरुत्’ स्वा । ‘नभोऽक्षरं’ हा । ‘मन्त्रेण’ क्षि प स्वा हेत्यक्षरचतुष्टयमन्त्रेण । ‘घटाम्बु मन्त्रितं कृत्वा’ कलशोदकमनेन मन्त्रेणाभिमन्त्रितं कृत्वा । ‘पादादिविहितधारानिपातनात्’ आपादमस्तकादिकृत-जलधारानिपातनात् । ‘भवति’ स्यात् । ‘विषनाशः’ दष्टस्य विषनाशः ।

मन्त्रोद्धारः—क्षिप स्वाहा ॥ इति निर्विषीकरणमन्त्रः ॥

इदानीमष्टविधनागाभिधानमभिधीयते—

अनन्तो वासुकिस्तक्षः कर्कोटः पद्मसंज्ञकः ।

महासरोजनामा च शङ्खपालस्तथा कुलिः ॥ १४ ॥

‘अनन्तो वासुकिस्तक्षः’ अनन्तनामा नागः, वासुकिर्नाम नागः, तक्षको नाम नागः । ‘कर्कोटः’ कर्कोटको नाम नागः । ‘पद्मसंज्ञकः’ पद्मनामा नागः । ‘महासरोजनामा च’ महापद्मनामनागः । ‘शङ्खपालः’ शङ्खपालो नाम नागः । ‘तथा कुलिः’ तेन प्रकारेण कुलिको नाम नागः । इत्यष्टविधनागानां नामानि निरूपितानि ॥

अतः परं तेषां नागानां कुल-जाति वर्ण-विष-व्यक्तयः पृथक्पृथग्भिधीयन्ते—

क्षत्रियकुलसम्भूतौ वासुकिशङ्खौ धराविषौ रक्तौ ।

कर्कोटकपद्मावपि शूद्रौ कृष्णौ च वारुणीयगरौ ॥ १५ ॥

‘क्षत्रियकुलसम्भूतौ’ क्षत्रियकुलसम्भवौ । कौ ? ‘वासुकिशङ्खौ’ वासुकिशङ्खपालनागौ । ‘धराविषौ’ तौ द्वौ पृथ्वीविषान्वितौ । ‘रक्तौ’ रक्तवर्णौ । ‘कर्कोटकपद्मावपि’ अपि-पश्चात् कर्कोटकपद्मौ । ‘शूद्रौ’ शूद्रकुलोद्भूतौ । ‘कृष्णौ’ तौ द्वौ कृष्णवर्णौ । चः समुच्चयः । ‘वारुणीयगरौ’ तौ द्वौ अग्निविषान्वितौ ॥

विप्रावनन्तकुलिकौ वह्निगरौ चन्द्रकान्तसङ्काशौ ।

तक्षकमहासरोजौ वैश्यौ पीतौ मरुद्गरौ ॥ १६ ॥

‘अनन्तकुलिकौ’ अनन्तकुलिकनामनागौ । ‘विप्रा’ विप्रकुलसम्भूतौ । ‘वह्निगरौ’ अग्निविषान्वितौ । ‘चन्द्रकान्तसङ्काशौ’ स्फटिकवर्णसदृशौ । ‘तक्षकमहासरोजौ’ तक्षकमहापद्मनामनागौ । ‘वैश्यौ’ वैश्यकुलोद्भवौ । ‘पीतौ’ पीतवर्णौ । ‘मरुद्गरौ’ वायुविषान्वितौ । इत्यष्टविधनागानां कुलवर्णविषव्यक्तयः प्रतिपादिताः । जयविजय-नागौ देवकुलोद्भूतौ आशीविषौ पृथिव्यां न प्रवर्तते इत्येतस्मिन्ग्रन्थे न प्रतिपादितौ ॥

१ हौ देवदत्तस्य विषं हर विषं हर हुं फट् इति ख पाठः ॥

इदानीं चतुर्विधं चिह्नमभिधीयते—

पार्थिवविषेण गुरुता जडता देहस्य सन्निपातत्वम् ।
लालाकण्ठनिरोधो गलनं दंशस्य तोयविषात् ॥ १७ ॥

‘पार्थिवविषेण’ पृथ्वीविषनागदष्टस्य । ‘गुरुता’ गुरुत्वम् । ‘जडता देहस्य’ शरीरस्य जाड्यम् । ‘सन्निपातत्वम्’ सन्निपातस्वरूपमिति पार्थिवविषचिह्नं स्यात् । ‘लालाकण्ठनिरोधः’ मुखे लालास्रवः । ‘गलनं दंशस्य’ सर्पदष्टदंशे रक्तक्षरणम् । कस्मात् ? ‘तोयविषात्’ अम्बुविषात् अम्बुविषदष्टस्यैवंविधं चिह्नं स्यात् ॥

गण्डोद्गमता दृष्टेरपाटवं भवति वह्निविषदोषात् ।
विच्छायतास्यशोषणमपि मारुतगरलदोषेण ॥ १८ ॥

‘गण्डोद्गमता’ दृष्टशरीरे गण्डोद्गमत्वम् । ‘दृष्टेरपाटवं’ नेत्रयोरपटुत्वम् । ‘भवति’ स्यात् । कस्मात् ? ‘वह्निविषदोषात्’ वह्निविषनागदष्टस्य पुरुषस्यैवंविधं चिह्नं स्यात् । ‘विच्छायता’ शरीरे दुश्छवित्वं, ‘आस्यशोषणमपि’ वदने निर्द्रवत्वमपि । केन ? ‘मारुतगरलदोषेण’ वायुविषदोषेण । वायुविषनागदष्टपुरुषस्यैवं चिह्नं स्यात् ॥
॥ इत्यष्टविधनागानां कुलवर्णविषचिह्नव्यक्तयः प्रतिपादिताः ॥

ॐ नमो भगवत्यादिमन्त्रमष्टोत्तरं शतम् ।
पठित्वा क्रोशपटहं ताडयेदष्टसन्निधौ ॥ १९ ॥

‘ॐ नमो भगवत्यादिमन्त्रं’ ॐ नमो भगवति० इत्यादि वक्ष्यमाणमन्त्रं । ‘अष्टोत्तरं शतं’ अष्टाधिकं शतम् । ‘पठित्वा’ पठनं कृत्वा । ‘क्रोशपटहं’ क्रोशडमरुम् । ‘ताडयेत्’ ताडनं कुर्यात् । ‘दष्टसन्निधौ’ दष्टस्य पार्श्वे ॥
मन्त्रोद्धारः— ॐ नमो भगवति ! वृद्धगरुडाय सर्वविषविनाशिनि ! छिन्द छिन्द मिन्द मिन्द । गृह्ण गृह्ण एहि एहि भगवति ! विद्ये हर हर हुं फट् स्वाहा ॥ दष्टश्रुतौ क्रोशपटहताडनमन्त्रः ॥

धृत्वार्धचन्द्रमुद्रां दक्षिणभागेऽहिदंशिनः स्थित्वा ।
वदतु तव गौरिदानीं तस्करलोकेन नीतेति ॥ २० ॥

‘धृत्वार्धचन्द्रमुद्राम्’ अर्धचन्द्राकारां—वामकराङ्गुष्ठतर्जनीभ्यां धृत्वा मुद्राम् । क ? ‘दक्षिणभागे’ दक्षिणदिग्भागे । कस्य ? ‘अहिदंशिनः’ सर्पदष्टपुरुषस्य । ‘स्थित्वा’ उषित्वा । ‘वदतु’ भाषताम् । किं वदतु ? ‘तव गौः’ त्वदीया गौः । ‘इदानीं’ साम्प्रतं । ‘तस्करलोकेन’ दस्युजनेन । ‘नीतेति’ गृहीत्वा नीतेति वदति ॥

तं समाहन्य पादेन याहीत्युक्ते स धावति ।
उत्थापयति तं शीघ्रं मन्त्रसामर्थ्यमीदृशम् ॥ २१ ॥

‘तं समाहन्य पादेन’ तं दष्टपुरुषं मन्त्रिणा स्वपादेन आहन्य । ‘याहीत्युक्ते’ गच्छेत्युक्ते । ‘स धावति’ स दष्टपुरुषो धावनं करोति । ‘उत्थापयति तं शीघ्रं’ तं दष्टपुरुषं झटित्युत्थापयति । ‘मन्त्रसामर्थ्यमीदृशं’ भगवत्या मन्त्रमाहात्म्यमीदृशं एवंविधम् ॥

॥ क्रोशपटहताडनेन दष्टोत्थापनविधानम् ॥

इदानीं नागाकर्षणमन्त्रविधानमभिधीयते—

नियुतजपात् संसिध्यति दशांशहोमेन फणिसमाकृष्टिः ।

प्रणवादिः स्वाहान्तः चिरिचिरिशब्दादिको मन्त्रः ॥ २२ ॥

‘नियुतजपात्’ लक्षजपात् । ‘संसिध्यति’ सम्यक् सिद्धिं प्राप्नोति । केन ? ‘दशांशहोमेन’ दशसहस्रहवनेन ।

‘फणिसमाकृष्टिः’ नागाकर्षणम् । ‘प्रणवादिः स्वाहान्तः’ उँकारादिः स्वाहाशब्दान्तः । ‘चिरिचिरिशब्दादिको मन्त्रः’
चिरिचिरि इति शब्दाद्यो मन्त्रः ॥

मन्त्रोद्धारः—उँ चिरि चिरि इन्द्रवारुणि ! एहि एहि कड कड स्वाहा ॥ इति नागाकृष्टिमन्त्रः ॥

इदानीं नागप्रेषणमन्त्रविधानमभिधीयते—

नागप्रेषणमन्त्रोऽशीतिसहस्रैर्दशांशहोमेन ।

सिध्यति जाप्येन पुनः शोणितकरवीरपुष्पाणाम् ॥ २३ ॥

‘नागप्रेषणमन्त्रः’ नागानां क्षुद्रकर्मकरणप्रस्थापनमन्त्रः । ‘अशीतिसहस्रैः’ अशीतिसहस्रप्रमाणैः । जाप्येन । कथम्भूतेन ? ‘दशांशहोमेन’ अष्टसहस्रहवनेन । ‘सिध्यति’ सिद्धिं प्राप्नोति । ‘पुनः’ पश्चात् । केषां ? ‘शोणित-करवीरपुष्पाणाम्’ रक्तकरवीरपुष्पाणाम् ॥

नागसम्प्रेषणमन्त्रोद्धारः—उँ नमो नागपिशाचि ! रक्ताक्षिभ्रुकुटिमुखि ! उच्छिष्टदीप्ततेजसे ! एहि एहि भगवति ! हुं फट् स्वाहा ॥ नागप्रेषणमन्त्रः ॥

वल्मीकनिकटे होमं कुर्यात् त्रिमधुरान्वितम् ।

मन्त्रसिद्धौ तमाज्ञाप्य प्रेषयेदुरगेश्वरम् ॥ २४ ॥

‘वल्मीकनिकटे’ वामलूरसमीपे । ‘होमं’ हवनम् । ‘कुर्यात्’ करोतु । ‘त्रिमधुरान्वितं’ क्षीराज्यशर्करामिश्रित प्राग्भारीकृतप्रसूनान्वितम् । ‘मन्त्रसिद्धौ’ एतद्विधानेन कृतमन्त्रसिद्धौ प्राप्तायां । ‘तमाज्ञाप्य’ तं नागेश्वरमाज्ञां कृत्वा । ‘प्रेषयेदुरगेश्वरं’ नागेश्वरं क्षुद्रकर्मकरणे प्रस्थापयेत् ॥ नागप्रेषण-कर्मकरण-जप-होमविधानमभिहितम् ॥

प्रेषितोऽहमनेनेति मा कस्यापि पुरो वदेः ।

अन्यमन्त्रेण मा गच्छ मानवं भक्षयामुकम् ॥ २५ ॥

‘प्रेषितः’ प्रस्थापितः । कः ? ‘अहं’ नागः । केन ? ‘अनेन’ मन्त्रवादिना । ‘इति’ एवम् । ‘कस्यापि पुरो मा वदेः’ कस्यापि पुरुषस्याग्रतः मा भाषस्व । ‘अन्यमन्त्रेण मा गच्छ’ एतन्मन्त्रं विहाय अन्यमन्त्रेण त्वं मा गच्छ । ‘मानवं भक्षयामुकं’ अमुकं दुष्टपुरुषं भक्षय ॥ इति नागप्रेषणविधानम् ॥

१ प्रणवादिस्वाहान्तश्चिरिधिरिशब्दादिको मन्त्रः इति ग पुस्तके पाठः ।

२ चिरि धिरि इति ग पाठः ।

इदानीं दूतपातनविधानमभिधीयते—

फणिदष्टस्य शरीरादोस्वाहामन्त्रतो विषं हृत्वा ।

सोमं श्रवल्ललाटाद् दूतं मन्त्रेण पातयेत् ॥ २६ ॥

‘फणिदष्टस्य शरीरात्’ सर्पदष्टस्य पुरुषस्य शरीरात् । ‘उं स्वाहा मन्त्रतः’ उं स्वाहेति वक्ष्यमाणमन्त्रात् । ‘विषम्’ दष्ट पुरुषदेहस्थं विषम् । ‘हृत्वा’ अपहृत्य । कथम् ? ‘सोमं श्रवत्’ अमृतं श्रवमाणम् । कस्मात् ? ‘ललाटात्’ भालस्थलात् । ‘दूतं’ प्रेषकम् । ‘मन्त्रेण पातयेत्’ पातयितव्यः ॥

एतन्मन्त्रोद्धारः—उं स्वाहा इत्यनेन मन्त्रेण विषमाहियते ।

उं नमो भगवते वज्रतुण्डाय स्वाहा रक्ताक्षि कुनखि दूतं पातय पातय मर मर धर धर ठ ठ ठ हुँ
फट्ट धे धे ॥ इति दूतपातनमन्त्रः ।

नूं लामोँ फड् मन्त्रोच्चारणतः पतति भोगिना दष्टः ।

नूं होमादिफडन्तो दष्टपटच्छादनो मन्त्रः ॥ २७ ॥

‘उं लामोँ फड् मन्त्रोच्चारणतः’ । इत्यनेन मन्त्रोच्चारणेन भूमौ पतति । कः ? ‘भोगिना दष्टः’ सर्पेण दष्टपुरुषः । ‘उं होमादिफडन्तः’ उं स्वाहा शब्दमार्दिं कृत्वा फट्शब्दान्तः—वक्ष्यमाणमन्त्रः । ‘दष्टपटच्छादनो मन्त्रः’ पतितदष्टपुरुषस्य शरीरोपरिवस्त्रच्छादनमन्त्रः ।

मन्त्रोद्धारः—उं लौँ उं फड् इति दष्टपातनमन्त्रः ।

उं स्वाहा रु रु रु रुँ हो प्लं सर्वं हारय संहारय उं र्यूँ उं उं गरुडाक्षि उं फट् ॥ इति दष्टपटच्छादनमन्त्रः ॥

पवननभोऽक्षरमन्त्रेणाकृष्य च धावते ततो वस्त्रम् ।

अनुधावति तत्पृष्ठे यत्र पटः पतति तत्रासौ ॥ २८ ॥

‘पवननभोऽक्षरमन्त्रेण’ स्वाहेत्यक्षरमन्त्रेण । ‘आकृष्य’ तद्दृष्टाच्छादनपटमाकृष्य । ‘धावते’ धावनं करोति । ‘ततः’ तस्मात् । ‘वस्त्रं’ आच्छादनपटम् । ‘अनुधावति तत्पृष्ठम्’ तद्वस्त्रमाकृष्य यः पुरुषो धावति तत्पृष्ठं स दष्टः अनुधावति । ‘यत्र पटः पतति तत्रासौ’ यस्मिन् स्थले तद् गृहीतपटः पतति तत्रैवासौ दष्टः पतति ॥ स्वाहेति दष्टाच्छादितपटाकर्षणमन्त्रः ॥

मन्त्रेणानेन फणी विषमुक्तो भवति जल्पितेन शनैः ।

अपहरति निजस्थानादशितेऽपि विषं न सङ्क्रमते ॥ २९ ॥

‘मन्त्रेणानेन’ अनेन कथितमन्त्रेण । ‘फणी विषमुक्तो भवति’ सर्पो विषमुक्तो भवति । केन ? ‘जल्पितेन’ वक्ष्यमाणमन्त्रपठनेन । ‘शनैः’ शनैरपि । ‘अपहरति निजस्थानात्’ स्वकीयस्थानात् तद्दृष्टस्य विषापहारो भवति । ‘अशितेऽपि विषं न सङ्क्रमते’ सर्पेण भक्षितेऽपि सति तस्य पुरुषस्यापि विषसङ्क्रमो न भवतीति निर्विषीकरणम् ॥

मन्त्रोद्धारः—ॐ नमो भगवते पार्श्वतीर्थङ्कराय हंसः महाहंसः पद्महंसः शिवहंसः कोपहंसः उरगेशहंसः पक्षि महाविषभक्षि हुँ फट्^१ ॥ इति निर्विषीकरणमन्त्रः ॥

तेजो नमः सहस्रादि मन्त्रं प्रपठतः फणी ।

अनुयाति ततः पृष्ठं याहीत्युक्ते निवर्तते ॥ ३० ॥

‘तेजो नमः सहस्रादि मन्त्रं प्रपठतः’ ॐ नमः सहस्रजिह्वे ! इत्यादि मन्त्रं प्रपठतः पुरुषस्य । ‘फणी’ सर्पः । ‘अनुयाति ततः पृष्ठं’ तन्मन्त्रपठितपुरुषस्य पृष्ठमनुगच्छति । ‘याहीत्युक्ते निवर्तते’ स एव सर्पः पुनरपि याहीत्युक्ते व्याघ्रुटय गच्छति ॥

तन्मन्त्रोद्धारः—ॐ नमो सहस्रजिह्वे ! कुमुदभोजिनि ! दीर्घकेशिनि ! उच्छिष्टभक्षिणि ! स्वाहा ॥

इति नागसहागमनमन्त्रः ॥

ॐ ह्रीं श्रीं ग्लौं हुँ क्षूं टान्तद्वितयेन फणिमुखस्तम्भः ।

हुँ क्षूं ठठेति गमने दृष्टिं ह्रीं क्षौं ठठेति बध्नाति ॥ ३१ ॥

‘ॐ ह्रीं श्रीं ग्लौं हुँ क्षूं’ । ‘टान्तद्वितयेन’ ठठेति मन्त्रेण । ‘फणिमुखस्तम्भः’ अनेन मन्त्रेण सर्पमुखस्तम्भो भवति । ‘हुँ क्षूं ठठेति गमने’ हुँ क्षूं ठठ इत्यनेन मन्त्रेण सर्पस्य गतिस्तम्भो भवति । ‘दृष्टिं ह्रीं क्षौं ठठेति बध्नाति’ सर्पस्य दृष्टिं ह्रीं क्षौं ठठ इति मन्त्रेण बध्नाति ॥ ॥ इति फणिमुख-गति-दृष्टिस्तम्भनविधिः ॥

वामं सुवर्णरेखाया गरुडाज्ञापयत्यतः ।

स्वाहान्तं मन्त्रमुच्चार्य कुण्डलीकरणं कुरु ॥ ३२ ॥

‘वामं सुवर्णरेखायाः’ ॐ सुवर्णरेखाया इति पदम् । ‘गरुडाज्ञापयत्यतः’ सुवर्णरेखापदानन्तरं गरुडाज्ञापयतीति पदम् । ‘स्वाहान्तं मन्त्रमुच्चार्य’ स्वाहाशब्दमन्ते कृत्वा तन्मन्त्रं पठित्वा । ‘कुण्डलीकरणं कुरु’ ।

मन्त्रोद्धारः—ॐ सुवर्णरेखाया गरुडाज्ञापयति कुण्डलीकरणं कुरु कुरु स्वाहा ॥

सप्रणवः स्वाहान्तो ललललललसंयुतः करोत्येषः ।

मन्त्रो घटप्रवेशं क्षणेन नागेश्वरस्यापि ॥ ३३ ॥

‘सप्रणवः स्वाहान्तः’ उकारादिः स्वाहाशब्दान्त्यः । ‘ललललललसंयुतः’ लललललल इत्यक्षरैः षड्भिर्युक्तः । ‘करोति’ कुरुते । ‘एषः मन्त्रः’ एतत्कथितमन्त्रः । किं करोति ? ‘घटप्रवेशं’ कुम्भप्रवेशं । ‘क्षणेन’ क्षणमात्रेण । कस्य ? ‘नागेश्वरस्यापि’ नागाधिपस्यापि क्षणेन घटप्रवेशं करोति ॥

मन्त्रोद्धारः—ॐ लललललल स्वाहा ॥ फणिकुम्भप्रवेशनमन्त्रः ॥

ॐ ह्राँ ह्रीं गरुडाज्ञा ठठेति तन्मुद्रया कृतां रेखाम् ।

भुजगो मरणावस्थां न लङ्घते तां कदाचिदपि ॥ ३४ ॥

‘उँ ह्रौँ ह्रीँ गरुडाज्ञा ठठेति’ उँ ह्रौँ ह्रीँ गरुडाज्ञा ठठ इत्यनेन मन्त्रेण । ‘तन्मुद्रया’ गरुडमुद्रया । ‘कृतां रेखां’ मन्त्रिणा भूमौ कृतां रेखां । ‘भुजगो मरणावस्थः’ सर्पो मरणावस्थां प्राप्तः । ‘न लङ्घते’ लङ्घनं कर्तुं न शक्नोति । ‘कदाचिदपि’ कस्मिंश्चित्कालेऽपि ॥

मन्त्रोद्धारः—उँ ह्रौँ ह्रीँ गरुडाय ठठ ॥ इति रेखामन्त्रः ॥

कपिकच्छूरसभावितखटिका प्रणवादिनील परिजप्त्वा ।

लेख्यस्तयोपदेशात् खटिकासर्पः शनेर्वारे ॥ ३५ ॥

‘कपिकच्छूरसभावितखटिका’ कण्डुकरीरसेन सप्तवारं भाविता खटिका । ‘प्रणवादिनील परिजप्त्वा’ सा खटिका प्रणवादि-नीलमन्त्रेण समं जप्त्वा । ‘लेख्यस्तया’ खटिकया लेखनीयः । कथम् ? ‘उपदेशात्’ उपदेशपूर्वेण । कः ? ‘खटिकासर्पः’ तत्खटिकालिखितसर्पः । कस्मिन् ? ‘शनेर्वारे’ शनिदिने ॥

मन्त्रोद्धारः—उँ नीलविषमहाविषसर्पसंक्रामणि ! स्वाहा ॥ इति विषसंक्रामणमन्त्रः ॥

यो हन्यात् तद्वक्त्रं खटिकासर्पो दशति नात्र सन्देहः ।

दृष्ट्वा करतलदशनं मूर्च्छति विषवेदनाकुलितः ॥ ३६ ॥

‘यो हन्यात् तद्वक्त्रं खटिकासर्पो दशति नात्र सन्देहः’ अत्र खटिकासर्पविधाने सन्देहो न कार्यः । ‘दृष्ट्वा करतलदशनं’ तत्सर्पदशनदंशं करतले दृष्ट्वा । ‘मूर्च्छति’ पुरुषो मूर्च्छां प्राप्नोति । कथम्भूतः ? ‘विषवेदनाकुलितः’ विषजनितवेदनाकुलितः । इति खटिकासर्पकौतुकविधानम् ॥

नैँ क्रौँ प्रौँ त्रीँ ठः मन्त्रेण विषं ह्रौँकारमध्यगं जप्त्वा ।

सूर्यं दशावलोक्य भक्षयेत् पूरकात् ततः ॥ ३७ ॥

अतः परं मूलविषविधानमभिधीयते—

‘उँ क्रौँ प्रौँ त्रीँ ठः मन्त्रेण’ अनेन मन्त्रेण । ‘विषं’ स्थावरविषम् । कथम्भूतम् ? ‘ह्रौँकारमध्यगम्’ करतलह्रौँकारमध्ये स्थितं विषं कथितमन्त्रेण । ‘जप्त्वा’ अभिमन्त्र्य । ‘सूर्यं’ रविं । ‘दशावलोक्य’ दृष्ट्या निरीक्ष्य । ‘भक्षयेत्’ विषभक्षणं कुर्यात् । कथम् ? ‘पूरकात् ततः’ पूरकयोगात् ॥

मन्त्रोद्धारः—उँ क्रौँ प्रौँ त्रीँ ठः ॥ इति विषभक्षणमन्त्रः ॥

प्रतिपक्षाय दातव्यं ध्यात्वा नीलनिभं विषम् ।

ग्लौँ ह्रौँ मन्त्रयित्वा तु ततो घे घेति मन्त्रिणा ॥ ३८ ॥

‘प्रतिपक्षाय’ शत्रुलोकाय । ‘दातव्यं’ देयम् । ‘ध्यात्वा’ ध्यानं कृत्वा । कथम्भूतम् ? ‘नीलनिभम्’ नीलवर्णस्वरूपम् । किम् ? ‘विषं’ मूलविषम् । किं कृत्वा ? ‘ग्लौँ ह्रौँ मन्त्रयित्वा’ इतिमन्त्रेणामिमन्त्र्य । ‘तु’ पुनः । ‘ततः’ ग्लौँ ह्रौँ इति बीजद्वयात् । ‘घेघेति’ घे घे इति पदं जपित्वा । केन ? ‘मन्त्रिणा’ मन्त्रवादिना ॥

मन्त्रोद्धारः—ग्लौँ ह्रौँ घे घे ॥

॥ इति प्रतिपक्षाय नीलध्यानेन युक्तविषदानमन्त्रः ॥

मुनिहयगन्धाघोषा वन्ध्या कटुतुम्बिका कुमारी च ।

त्रिकटुककुष्ठेन्द्रयवा घ्नन्ति विषं नस्यपानेन ॥ ३९ ॥

‘मुनिः’ अगस्तिः । ‘हयगन्धा’ अश्वगन्धा । ‘घोषा’ देवदाली । ‘वन्ध्या’ कर्कोटी । ‘कटुतुम्बिका’ कटुकालाबुका । ‘कुमारी’ गृहकन्या । ‘त्रिकटुकं’ त्र्यूषणम् । ‘कुष्ठम्’ रुक् । ‘इन्द्रयवा’ कुटजबीजम् । ‘घ्नन्ति’ नाशयन्ति । ‘विषं’ स्थावरजङ्गमविषम् । कथम् ? ‘नस्यपानेन’ एतदौषधानां नस्येन पानेन च सर्वं विषं नश्यति ॥

द्विपमलभूतच्छत्रं रविदुग्धं श्लेष्मतरुफलोपेतम् ।

वृश्चिकविषसङ्ग्रामं बदरीतरुदण्डसंयोगात् ॥ ४० ॥

‘द्विपमलभूतच्छत्रं’ द्विरदमलोद्भूतच्छत्रम् । ‘रविदुग्धं’ मार्तण्डक्षीरम् । ‘श्लेष्मतरुफलोपेतम्’ श्लेष्मातक-फलचिकान्वितम् । ‘वृश्चिकविषसंक्रामं’ वृश्चिकविषोत्तारणं अन्येषां विषसंक्रामम् । ‘बदरीफलदण्डसंयोगात्’ पुष्यार्के ऊर्ध्वाधोगतकण्टकद्वयान्वितबदरीशलाकां गृहीत्वा तदौषधत्रयलेपं कृत्वा ऊर्ध्वकण्टकेनोत्तार्य अधोगत-कण्टकेन अन्योऽन्यं संक्रामति ॥

षट्कोणभवनमध्ये कुरुकुलां यो लिखेद् गृहे विद्याम् ।

तत्र न तिष्ठति नागो लिखिते नागारिवन्धेन ॥ ४१ ॥

‘षट्कोणभवनमध्ये’ षट्कोणचक्रमध्ये । ‘कुरुकुलां’ कुरुकुलानामदेव्या मन्त्रः । ‘यो लिखेद्’ यः कोऽपि मन्त्रवादी लिखेत् । क ? ‘गृहे’ गृहदेहेत्याम्, स्ववासोत्तराङ्गे । काम् ? ‘विद्याम्’ कुरुकुलादेव्या विद्याम् । ‘तत्र’ तस्मिन् गृहे । ‘न तिष्ठति’ न स्थाति । कः ? ‘नागः’ सर्पः । कस्मिन् कृते सति ? ‘लिखिते’ सति । केन ? ‘नागारिवन्धेन’ गरुडबन्धेन ॥

मन्त्रः—ॐ कुरुकुले ! हूं फट् ॥

इदानीं मण्डलोद्धारणमभिधीयते—

चतुरस्रं मण्डलमतिरमणीयं पञ्चवर्णचूर्णेन ।

प्रविलिख्य चतुःकोणे तोयभृतान् स्थापयेत् कलशान् ॥ ४२ ॥

‘चतुरस्रं’ समचतुरस्रम् । ‘मण्डलं’ वक्ष्यमाणमण्डलम् । ‘अतिरमणीयं’ अत्यन्तशोभमानम् । ‘पञ्चवर्णचूर्णेन’ श्वेतरक्तपीतहरितकृष्णमिति पञ्चवर्णचूर्णेन । ‘प्रविलिख्य’ प्रकर्षेण लिखित्वा । ‘चतुःकोणे’ तन्मण्डलचतुःकोणे । ‘तोयभृतान्’ जलपरिपूर्णान् । स्थापयेत् । कान् ? ‘कलशान्’ कुम्भान् ॥

तस्योपरि विपुलतरं मण्डपमतिसुरभिपुष्पमालिकाकीर्णम् ।

चन्द्रोयकध्वजतोरणघण्टारवदर्पणोपेतम् ॥ ४३ ॥

‘तस्योपरि’ तन्मण्डलोपरि । ‘विपुलतरं’ अतिविस्तीर्णम् । ‘मण्डपं’ । कथम्भूतम् ? ‘अतिसुरभिपुष्प-मालिकाकीर्णम्’ । पुनः कथम्भूतम् ? ‘चन्द्रोयकध्वजतोरणघण्टारवदर्पणोपेतम्’ वितानध्वजवन्दनमालाक्षुद्रघण्टिका-विशिष्टदर्पणान्वितम् ॥

पञ्चपरमेष्ठिमन्त्रं प्रत्येकं प्रणवपूर्वहोमान्तम् ।

अष्टदलकमलमध्ये हिमकुङ्कुममलयजैर्विलिखेत् ॥ ४४ ॥

‘पञ्चपरमेष्ठिमन्त्रं’ अर्हत्सिद्धान्तार्योपाध्यायसर्वसाधूनां मन्त्रम् । अमुं च कथम्भूतम् ? ‘प्रत्येकं’ पृथक्पृथक् । ‘प्रणवपूर्वहोमान्तं’ उकारादिस्वाहाशब्दान्तम् । ‘अष्टदलकमलमध्ये’ अष्टदलाम्बुजमध्ये—अष्टदलकर्णिकामध्ये । ‘हिमकुङ्कुममलयजैः’ कर्पूरकाश्मीरश्रीगन्धैः । ‘विलिखेत्’ विशेषेण लिखेत् ॥

मन्त्रोद्धारः—ॐ अर्हञ्च्यः स्वाहा, ॐ सिद्धेभ्यः स्वाहा, ॐ सूरिभ्यः स्वाहा, ॐ पाठकेभ्यः स्वाहा, ॐ सर्वसाधुभ्यः स्वाहा । इति पञ्चपरमेष्ठिनां मन्त्रं कर्णिकामध्ये लिखेत् ॥

पूर्वाग्न्यादिषु दद्याज्जयादिजम्भादिदेवता ह्येताः

तद्दक्षिणदिग्भागे हेममयीं पादुकां देव्याः ॥ ४५ ॥

‘पूर्वाग्न्यादिषु’ पूर्वादिचतुर्दिशासु आग्नेय्यादिचतुर्विदिशासु च । ‘हि’ स्फुटम् । ‘एताः’ कथितदेवताः । ‘तद्दक्षिणदिग्भागे’ तन्मण्डलदक्षिणदिक्प्रदेशे । ‘हेममयीं’ स्वर्णविनिर्मिताम् । ‘पादुकां देव्याः’ पादुकाद्वयं दद्याद्देव्याः ॥

स्थापनक्रमः—जये स्वाहेति प्राच्यां दिशि १, ॐ विजये स्वाहेति दक्षिणायां दिशि २, ॐ अजिते स्वाहेति प्रतीच्यां दिशि ३, ॐ अपराजिते स्वाहेति उत्तरस्यां दिशि ४, ॐ जम्भे स्वाहेत्याग्नेय्यां दिशि ५, ॐ मोहे स्वाहेति नैऋत्यां दिशि ६, ॐ स्तम्भे स्वाहेति वायव्यायां दिशि ७, ॐ स्तम्भिनि स्वाहेतीशान्यां दिशि ८, इत्यष्टदलेषु जयादिजम्भादिदेवता विलिखेत् ॥

अभ्यर्च्य गन्धतन्दुलकुसुमनिवेद्यप्रदीपधूपफलैः ।

परमेष्ठिनं च मन्त्रं भैरवपद्मावतीपादौ ॥ ४६ ॥

‘अभ्यर्च्य’ अभिपूज्य । कैः ? ‘गन्धतन्दुलकुसुमनिवेद्यप्रदीपधूपफलैः’ श्रीगन्धाक्षतपुष्पचरुनैवेद्यदीपधूप-फलाद्यष्टविधार्चनाद्रव्यैः । ‘परमेष्ठिनं च मन्त्रम्’ पञ्चपरमेष्ठिमन्त्रम् । ‘अभ्यर्च्य’ पूजयित्वा । ‘पूजयेत् भैरव-पद्मावतीपादौ’ भैरवपद्मावतीदेव्याः पादौ—स्वर्णपादुके अपि पूजयेत् ॥

परसमयजनविरक्तं शिष्यं जिनसमयदेवगुरुभक्तम् ।

कृतवस्त्रालङ्कारं संस्नातं मण्डलाभिमुखम् ॥ ४७ ॥

‘परसमयजनविरक्तम्’ मिथ्याशासनलोकविरक्तम् । ‘शिष्यं’ विनेयम् । पुनः कथम्भूतम् ? ‘जिनसमय-देवगुरुभक्तम्’ जिनशासनदेवतासद्गुरुभक्तम् । ‘कृतवस्त्रालङ्कारं’ कृतो वस्त्रालङ्कारो येनासौ कृतवस्त्रालङ्कारः तम् कृतवस्त्रालङ्कारम् । पुनः कथम्भूतम् ? ‘संस्नातम्’ सम्यक्स्नातम् । ‘मण्डलाभिमुखम्’ उद्धारितमण्डलस्याभिमुखम् ॥

संस्नाप्य चतुःकलशैः सहिरण्यैस्तं ततोऽन्यवस्त्रादीन् ।

दत्त्वा तस्मै मन्त्रं निवेदयेत् गुरुकुलायातम् ॥ ४८ ॥

‘संस्नाप्य’ तं शिष्यं सम्यक्स्नापयित्वा । कैः ? ‘चतुःकलशैः’ प्राञ्जलकोणस्थचतुःपूर्णकलशैः । कथम्भूतैः ? ‘सहिरण्यैः’ स्वर्णयुक्तैः । ‘तं’ शिष्यम् । ‘ततः’ स्नानानन्तरम् । ‘अन्यवस्त्रादीन्दत्त्वा’ पूर्ववस्त्रादीनपहायान्यनववस्त्रादीन् दत्त्वा । ‘तस्मै’ एवंविधशिष्याय । ‘मन्त्रं निवेदयेत्’ । कथम्भूतं मन्त्रम् ? ‘गुरुकुलायातम्’ गुरुपारम्पर्येणागतम् ॥

भवतेऽस्माभिर्दत्तो मन्त्रोऽयं गुरुपरम्परायातः ।

साक्षीकृत्य हुताशनरविशशिताराम्बराद्रिगणान् ॥ ४९ ॥

‘भवते’ तुभ्यं शिष्याय । ‘अस्माभिर्दत्तः’ । ‘मन्त्रोऽयं’ प्राक्कथितमन्त्रः । कथम्भूतः ? ‘गुरुपरम्परायातः’ गुरुपारम्पर्येणागतः । किं कृत्वा ? ‘साक्षीकृत्य’ साक्षिकं कृत्वा । कान् ? ‘हुताशनरविशशिताराम्बराद्रिगणान्’ अन्यर्कचन्द्रनक्षत्राकाशाद्रिसमूहान् ॥

भवतापि न दातव्यः सम्यक्त्वविवर्जिताय पुरुषाय ।

किन्तु गुरुदेवसमयिषु भक्तिमते गुणसमेताय ॥ ५० ॥

‘भवतापि’ त्वयापि । ‘न दातव्यः’ न देयः । कस्मै ? ‘सम्यक्त्वविवर्जिताय’ सम्यक्त्वविहीनाय । ‘पुरुषाय’ नराय । ‘किन्तु’ अथवा । ‘गुरुदेवसमयिषु भक्तिमते’ गुरुदेवसमये भक्तियुक्ताय । ‘गुणसमेताय’ सकलगुणसंयुक्ताय एवंगुणविशिष्टाय पुरुषाय दातव्यः ॥

लोभादथवा स्नेहादास्यसि चेदन्यसमयभक्ताय ।

बालस्त्रीगोमुनिवधपापं यत्तद्भविष्यति ते ॥ ५१ ॥

‘लोभात्’ अर्थाभिलाषात् । अथवा ‘स्नेहात्’ व्यामोहात् । ‘दास्यसि चेत्’ यदि इमां विद्यां दास्यसि । कस्मै ? ‘अन्यसमयभक्ताय’ परसमयभक्तियुक्ताय । तदा ‘बालस्त्रीगोमुनिवधपापं यत्’ बालकस्त्रीजनगोमुनिजनहननेन यत् पापम् । ‘तद्भविष्यति ते’ तत् पापं तव भविष्यति ।

इत्येवं श्रावयित्वा तं सन्निधौ गुरुदेवयोः ।

मन्त्री समर्पयेन्मन्त्रं मन्त्रसाधनयोगतः ॥ ५२ ॥

‘तं’ मन्त्रप्राहकम् । ‘इत्येवं श्रावयित्वा’ इत्यनेन प्रकारेण शपथं कारयित्वा । कथम् ? ‘सन्निधौ गुरुदेवयोः’ गुरुदेवयोः सन्निधाने । ‘मन्त्री’ मन्त्रवादी । ‘समर्पयेत्’ नियोजयेत् । कम् ? ‘मन्त्रम्’ गुरुपारम्पर्यागतं मन्त्रम् । कथम् ? ‘मन्त्रसाधनयोगतः’ मन्त्राराधनविधानयोगात् ॥

प्रशस्तिः—

सकलनृपमुकुटघटितचरणयुगः श्रीमदजितसेनगणी ।

जयतु दुरितापहारी भव्यौघभवार्णवोत्तारी ॥ ५३ ॥

‘सकलनृपमुकुटघटितचरणयुगः’ सकलभूपालमुकुटघटितपादारविन्दद्वयः । ‘श्रीमदजितसेनगणी’ श्रीमद-जितसेनाचार्यः । ‘जयतु’ सर्वोत्कर्षेण वर्तताम् । ‘दुरितापहारी’ पापापहारी । पुनः कथम्भूतः ? ‘भव्यौघ-भवार्णवोत्तारी’ भव्यजनसमूहस्य संसारसमुद्रोत्तारकः ।

जिनसमयागमवेदी गुरुतरसंसारकाननोच्छेदी ।

कर्मेन्धनदहनपटुस्तच्छिष्यः कनकसेनगणिः ॥ ५४ ॥

‘जिनसमयागमवेदी’ जिनेश्वरसमयसकलागमज्ञाता । ‘गुरुतरसंसारकाननोच्छेदी’ दुर्धरसंस्तिकान्तारो-न्मूलनसमर्थः । ‘कर्मेन्धनदहनपटुः’ सकलकर्मेन्धनदहनक्रियायां अतीव दक्षः । ‘तच्छिष्यः’ श्रीमदजितसेनाचार्यस्य शिष्यः । कः ? ‘कनकसेनगणी’ कनकसेनाचार्यः ॥

चारित्रभूषिताङ्गो निःसङ्गो मथितदुर्जयानङ्गः ।

तच्छिष्यो जिनसेनो बभूव भव्याब्जघर्मांशुः ॥ ५५ ॥

‘चारित्रभूषिताङ्गः’ सकलचारित्रभूषितशरीरः । ‘निःसङ्गः’ बाह्याभ्यन्तरपरिग्रहरहितः । ‘मथितदुर्जयानङ्गः’ दुर्जयध्वंसौ अनङ्गश्च दुर्जयानङ्गः मथितो दुर्जयानङ्गो येन स मथितदुर्जयानङ्गः निर्जितमदनः । ‘तच्छिष्यः’ कनकसेनाचार्यस्य शिष्यः । कः ? ‘जिनसेनः’ जिनसेनाचार्यः । ‘बभूव’ सजातः । कथम्भूतः ? ‘भव्याब्जघर्मांशुः’ भव्यकमलप्रबोधनदिवाकरः ॥

तदीयशिष्योऽजनि मल्लिषेणः सरस्वतीलब्धवरप्रसादः ।

तेनोदितो भैरवदेवताया कल्पः समासेन चतुःशतेन ॥ ५६ ॥

‘तदीयशिष्यः’ जिनसेनाचार्यस्य शिष्यः । ‘अजनि’ जातः । कः ? ‘मल्लिषेणः’ मल्लिषेणाचार्यः । कथम्भूतः ? ‘सरस्वतीलब्धवरप्रसादः’ सरस्वतीदेव्याः सकाशात् प्राप्तवरप्रसादः । ‘तेन’ मल्लिषेणाचार्येण । ‘उदितः’ कथितः । ‘भैरवदेवतायाः’ भैरवपद्मावतीदेव्याः । ‘कल्पः’ मन्त्रवादसमूहः । ‘समासेन’ संक्षेपेण । ‘चतुःशतेन’ चतुःशत-सङ्ख्याप्रन्थप्रमाणेन ॥

यावद्वार्धिमहीधरतारागणगगनचन्द्रदिनपतयः ।

तिष्ठन्ति तावदास्तां भैरवपद्मावतीकल्पः ॥ ५७ ॥

‘यावत्’ यावत्कालपर्यन्तम् । ‘वार्धिः’ समुद्रः । ‘महीधरः’ कुलशैलः । ‘तारागणः’ नक्षत्रसमूहः । ‘गगनं’ आकाशः । ‘चन्द्रः’ मृगाङ्कः । ‘दिनपतिः’ मार्तण्डः । एते वार्ध्यादयो यावत्कालपर्यन्तं ‘तिष्ठन्ति’ स्थास्यन्ति । ‘तावत्’ तावत्कालपर्यन्तम् । ‘आस्ताम्’ तिष्ठतु । ‘भैरवपद्मावतीकल्पः’ भैरवपद्मावतीनामदेव्याः मन्त्रकल्पः ॥

इत्युभयभाषाकविशेखरश्रीमल्लिषेणसूरिविरचितो

भैरवपद्मावतीकल्पः समाप्तः ॥

परिशिष्टानि

परिशिष्ट १

श्वेताम्बरचक्रचूडामणिश्रीयशोभद्रोपाध्यायशिष्यश्रीचन्द्रसूरिविरचितः

अद्भुतपद्मावतीकल्पः ।

श्रीपार्श्वनाथाय नमः ।

शकलीकरणलक्षणं तृतीयं प्रकरणम् ॥३॥

पूर्वं पूर्वाभिमुखः स्नातः शुभवस्त्रभूषितः सुरभिः ।
पर्यङ्कासनसंस्थो नासाग्रन्यस्तद्व्युगमः ॥ १ ॥
निर्मलनिर्जनदेशे स्थित्वा मन्त्री निरुध्य वायुं च ।
आपूर्य शनैरन्तो रेचकविधिना ततस्तूर्ध्वम् ॥ २ ॥
उत्क्षिप्य च धूमशिखाकारेण विधूय पापरेणुं च ।
आत्मानं कर्मेन्धनपुञ्जस्योपरि स्थितं स्मरेत् ॥ ३ ॥

त्रिभिः कुलकम् ।

दीपशिखाकारेण तु तदधो जाज्वल्यमानरेफं च ।
निजहृदये चाकारं विचिन्तयेदात्मरूपेण ॥ ४ ॥
प्रविचिन्त्य धकारं तद्रेफस्याधश्च वायुरूपेण ।
दन्दह्यमानमग्निकबीजेनात्मानमवमत्य ॥ ५ ॥
भस्मीभूतमकारकबीजात्मकशेषमुपरि तस्यैव ।
मेघाकारेण ततस्त्वधो मुखाकारबीजमाकाशे ॥ ६ ॥
वर्षन्तममृतमुक्ताफलसन्निभतोयनिकरेण ।
प्लवमानं संस्मरयेत् परितो मन्त्री च सदहृदयः ॥ ७ ॥

त्रिभिः कुलकम् ॥

दिक्छदनममलकमलं तदमृतभावोद्भवं सदा विकचम् ।
 तत्कर्णिकमध्यगतं सुधोद्भवात्मानमर्जुनभम् ॥ ८ ॥
 पर्यङ्कासनसंस्थितमिति ध्यात्वाऽथ हृदि करवलेन ।
 षोडशदशमम्बुरुहं तत्कर्णिकमध्यमूर्ध्वस्थान् ॥ ९ ॥
 'पविनन्दावर्तयवांस्तदुपरि संस्थाप्य पार्श्वजिननाथम् ।
 निखिलकलक्षणार्ढ्यं विविधचतुस्त्रिंशदतिशयोपेतम् ॥ १० ॥
 पापमथनाष्टकमहाप्रातिहार्ययुक्तं ततस्ततः परिधौ ।
 तत्केशरेषु मरुदेव्यादिकजननीगणं न्यस्य ॥ ११ ॥
 तत्पत्रगता रोहिणिमुख्याश्च द्व्यष्टदेवताः क्रमशः ।
 इति विन्यस्य च मन्त्री ध्यानविधानं करोतु सदा ॥ १२ ॥
 चतुर्भिः कलापकम् ।

अर्हत्सिद्धाचार्योपाध्यायान् सर्वसाधुयुतान् ।
 अङ्गुष्ठाद्यङ्गुलितत्पर्षसु संन्यस्य वाद्यन्तान् ॥ १३ ॥
 'होमान्ताः ३ प्रणवनमोमुख्याः ५ पञ्चपरमेष्ठिमध्यगताः ।
 हाँ हीं हूँ ह्रौँ हः शरबीजाः प्रान्त्यादिदेशपदाः ॥ १४ ॥
 त्रीन् वारान् पञ्चाङ्गुलिमन्त्रणमाधाय जल्पितैर्मन्त्रैः ।
 सर्वकरेण तैरपि 'ललाटमुख्यादिपञ्चकं मन्त्र्यम् ॥ १५ ॥
 सव्यासव्यकराभ्यां त्रीनथ हृदयं शिरःशिखां वारान् ।
 कवचीकृत्य च तैरपि मुख्यं मन्त्रं ततो ध्यायेत् ॥ १६ ॥
 चतुर्भिः कलापकम् ॥

इति शकलविधानं शाकिनीदुष्टभूत-
 प्रहगणभवपीडाकष्टनिष्ठापनाग्निः ।
 स्वकवपुषि विधाय भ्रान्तिनिर्घाटनं च
 तदनु रचतु मन्त्री देवीपूजाक्रमं हि ॥ १७ ॥

इति श्वेताम्बरचक्रचूडामणिश्रीयशोभद्रोपाध्याय-
 शिष्यचन्द्रप्रकाशितेऽद्भुतपद्मावतीकल्पे
 शकलीकरणलक्षणं तृतीयं^६
 समाप्तम् ॥ ३ ॥

१ वज्रम् । २ स्वाहान्ताः । ३ ॐकार० । ४ 'अरिहंताणं' इत्यादीनि लभ्यन्ते । ५ शीर्षं, वदनं, हृदयं,
 नाभिः, पादौ चेति मुख्यादिपञ्चकम् । ६ आद्यप्रकरणद्वयं न कापि दृष्टिगोचरीबभूव मे ।

देव्यर्चनाक्रमसयन्त्रलक्षणं चतुर्थं प्रकरणम् ॥४॥

उद्यानवने जिनवरहृदिनीतटेऽथवा पुलिने ।
नगकटके निर्जन्तुकदेशे वाऽन्यत्र संस्थाय ॥ १ ॥
अऊकल्लवर्जं ^१कूटैर्दशभिः ^२कलाभिरधियुक्तैः ।
प्राच्यादिदिग्बिबन्धं पूर्वं मन्त्री करोतु शुचिः ॥ २ ॥ युग्मम् ॥
ध्यायेत् पीतमखण्डं रानुस्रं (?) वज्रपञ्जरं स्वस्य ।
परितो दुष्टैरन्यैरमेद्यमेतत् ततः स्थिरधीः ॥ ३ ॥
यन्मध्यगतं दुष्टग्रहो जिघांसुर्न लङ्घयेत् कोऽपि ।
मन्त्रार्चादिप्रभृतिनि कार्ये सर्वत्र मन्त्रविदम् ॥ ४ ॥
याति ग्रहोऽपि धूर्तस्त्यक्त्वा पात्रं हि चेत् तदानीं तु ।
आशाबन्धं मन्त्रं कुर्यादित्थं पुरा गदितम् ॥ ५ ॥
आकर्षणं वसन्ते ग्रीष्मे विद्वेषमुच्चाटम् ।
प्रावृडि शिशिरे मारणमथ शान्तिं शरदि मन्त्रविदः ॥ ६ ॥
हेमन्ते पौष्टिकमिह ये कुर्वन्त्यविरतं नियतम् ।
सकलत्रिलोकमूर्धनि भवन्ति ते पूजनीया हि ॥ ७ ॥
पूर्वाह्णेऽथ वसन्तं मध्याह्णे ग्रीष्ममपराह्णे ।
प्रावृडपि प्रदोषे शिशिरं शरदं तथाऽर्धनिशि ॥ ८ ॥
हेमन्तमुषाप्राप्ते मन्त्रविदो विदुरसन्दिग्धम् ।
कर्मैभिः कालैः कृतमिह सिद्धिं याति नो वितथम् ॥ ९ ॥
एतद् विदन्ति केचित् पुनरन्ये चैतदेव विवदन्ति ।
षट्कर्मकृतिविधानं सम्यक् सन्मन्त्रतन्त्रविदः ॥ १० ॥
वश्यविधानं पूर्वाह्णे मध्याह्णे प्रीतिनाशनं झटिति ।
उच्चाटनमपराह्णे सन्ध्यायां मारणं तदनु ॥ ११ ॥
शान्तित्वमर्धरात्रे प्रातः पौष्टिकमामनन्ति बुधाः ।
अनयोरेकान्मध्ये यद्युक्तं तत् करोतु सदा ॥ १२ ॥
कुकुडं ^३नीरज-दण्ड-स्वस्तिक-पवि-भद्रपीठकास्यानि^४ ।
द्वेषण-शान्त्याकर्षण-वशीकरण-रोध-बोध-वधसमये ॥ १३ ॥
पवि-कमल-^५बोध-वल्लव-शङ्खाङ्कुशलक्षणा हि षण्मुद्राः ।
वध-वश्य-शान्ति-विद्वेषण-रोधाकृष्टिकार्येषु ॥ १४ ॥

१ क्षकारैः । २ अनुस्वारविसर्जनीयसहितानां स्वराणां कला इति सङ्ज्ञा भवति । ३ पद्मम् । ४ आस-
नानि । ५ बोधो मुद्रयस्य मुद्रा ।

शान्त्युच्चाटन-मारण-विद्वेषाकृष्टि-वश्य-संस्तम्भाः ।
 १ उदधि-मरुद्धर-वसु-यम-सोमाऽमरदिक्षु नैर्ऋते पुष्टिः ॥ १५ ॥
 रोध-ग्रथन-विदर्भण-दीपन-पल्लवसम्पुटैः क्रियते ।
 वध-नाशा-कृष्टि-स्तम्भन-शान्ति-विद्वेषण-वशीकृतिविधानम् ॥ १६ ॥
 आदौ मध्ये चान्ते नामनिवेशो हि रोध आख्यातः ।
 वर्णान्तरितं ग्रथनं द्विवर्णमध्ये विदर्भश्च ॥ १७ ॥
 आदौ दीपनमन्ते सुपल्लवः सम्पुटं तदन्तरगम् ।
 एवं षट्कर्मकृतिं ज्ञात्वा मन्त्री जपेन्मन्त्रम् ॥ १८ ॥
 ब्रह्मादिपाशकाङ्कुशमाया वाग्बीजचित्तनाथमथ ।
 ह्रीं षान्त्युतं पद्मावत्यै नम एवमादिमं मन्त्रम् ॥ १९ ॥
 हेयं मन्त्रस्यान्ते जाप्ये समये सदा नमःशब्दः ।
 स्वाहा तु होमकाले मन्त्रस्यासौ क्रमः प्रोक्तः ॥ २० ॥
 वश्ये वषडुच्चाटे फट् हुं द्वेषे च शान्तिके स्वाहा ।
 आकृष्टौ वौषट् घे मारे पौष्टौ स्वधेति मन्त्री ते ॥ २१ ॥
 अङ्गुष्ठादावङ्गुलिमणयोऽङ्गुष्ठेन संविवर्त्यन्ते ।
 मोक्षाभिचार^२ शान्तिकवशीकराकृष्टिकरणविधौ ॥ २२ ॥
 पूर्वमभिमन्त्र्य सलिलं मन्त्रेणाद्येन सप्तवारं हि ।
 भूम्युपकरणादीनां शुद्धिं विदधातु सिद्धये मन्त्री ॥ २३ ॥
 निर्दोषपट्टममलं धौतं शुचिवारिणा च विन्यस्य ।
 ३ रोचनचन्दनकुङ्कुमघनसारप्रभृतिसुरभिभिलिप्तम् ॥ २४ ॥
 निर्याति मरुति मन्त्री शतपत्रकविमलवृन्तकाग्रेण ।
 मौनावलम्बनिरतो मण्डलमेवं न्यसेत् तत्र ॥ २५ ॥
 सोल्लोचमण्डपलसत्केतुपताकादिमण्डितं विपुलम् ।
 विदिशि निवेशितकुम्भं सन्मुसलमथ भूततोरणकम् ॥ २६ ॥ युग्मम् ॥
 पूर्वाग्निमनैर्ऋतपश्चिमवायूत्तरेशदिकृचक्रम^४ ।
 ५ तत्त्वादिनमोऽन्त्युतं सृष्ट्या स्थाप्यं क्रमाद्भिखिलम् ॥ २७ ॥
 ६ श्रीवाग्बीजकमायाधरणेन्द्राय नम एव पाताले ।
 स्वर्गाय नमोऽत्रादिमबीजेन्द्राय^७ नम एव ततः ॥ २८ ॥

१ पश्चिम-वायव्यकोण-ईशान-आग्नेय-दक्षिण-उत्तर-पूर्वदिक्षु । २ उच्चाटनम् । ३ गोरोचना । ४
 ईश-ईशानदिक् । ५ ॐकारः । ६ वाग्बीजं-ऐङ्कारः, माया तु ह्रीं, श्रीं-ह्रीं धरणेन्द्राय नमः, पातालाय
 नमः इत्याम्नायः । ७ श्रीं-ह्रीं इन्द्राय नमः ।

द्विपुटितवह्निपुरान्तः सप्तफटाराजिमुखकमलम् ।
 नीलोत्पलदलदेहं सश्रीकं न्यस्य पार्श्वजिनम् ॥ २९ ॥
 तदधः सुधाङ्गधवलां चतुर्भुजां लोचनत्रिकोपेताम् ।
 मन्त्रात्मिकां न्यसेत् श्रीसुभगां पद्मावतीं देवीम् ॥ ३० ॥ युग्मम्
 तत्पूर्वकोणमुख्यात् ^१तेजो-माया-स्मरादिपूर्वनमः ।
 नित्या^२ क्लिन्नाथ मदा स्यादुन्मादा द्रवाद्रवा ॥ ३१ ॥
 स्यात् तत्परितो वलयेऽन्तनमः षण्मुख्यमन्त्रवर्णाद्याः ।
 कामा-कुसुमाऽनङ्गा प्रत्येकं ^३बाणपूर्विकान्येवम् ॥ ३२ ॥
 षोडशकोष्ठे तदुपरि ^४मायाद्यन्तनमोयुताः क्रमशः ।
 रोहिण्या प्रज्ञप्ती ^५पविपूर्वा शृङ्खलांकुशा चक्रा ॥ ३३ ॥
 मानवदत्ता काली महायुताऽन्या च गौरी स्यात् ।
 गन्धारी जालन्धरी वैरोद्या मानवी तथाऽच्छुप्ता ॥ ३४ ॥
 मानस्यसावपि महायुक्ता चेति देवता द्वयष्टौ ।
 त्रिवलयमध्ये तदुपरि दण्डेशा विंशदेवतायाः स्युः ॥ ३५ ॥
 करिराजपद्मदेवासिखिजालौ शोणितांशनाशाडैः ।
 केशिश्चण्डः कर्दभभुवनभ्रमणा महारक्तः ॥ ३६ ॥
 कृष्णो विजयः सिंहः सुस्निग्धो रुद्रजम्भवौ सृष्टया ।
 सिद्धार्थश्चेति नमः प्रान्ता ह्रीमादयश्चेते ॥ ३७ ॥
^६तदुपरि युगवलये श्रीदेव्याः^७ सख्यश्चतुर्विंशाः ।
^८मायादिजया विजया च जयन्त्यपराजिता च मन्दा च ॥ ३८ ॥
 भद्रा रुद्रा च करालिका च योगिन्यथ शिवा च ।
 सा नन्दाऽथो अमला कमला पद्मा ^९महाग्रथयोगिन्यः ॥ ३९ ॥
^{१०}सुयुते यन्त्रारूपे चित्रा वियुता परा च जम्भा च ।
 स्तम्भा दम्भा मोहा सिद्धेति नमोऽन्तका चेति ॥ ४० ॥
 पञ्चमवलये ततः पद्मावत्यङ्गरक्षकाः सुभगाः ।
 तुर्यसहस्रा निजनिजशस्त्रयुताः स्युः ससोममुखाः ॥ ४१ ॥
 देवीसख्यस्त्रयष्टावासां प्रत्येकमस्ति परिवारः ।
 पञ्चशतसंख्ययुक्ते ज्ञेयस्तत्रैव गुरुवचनात् ॥ ४२ ॥

१ तेज इति ॐकारः । २ ॐह्रीं क्लीं नित्यायै नमः । ३ कामबाण इत्यादि । ४ ह्रींरोहीणी
 नमः । ५ वज्रशृङ्खला, वज्राङ्कुशी । ६ चतुर्थवलये । ७ पद्मावत्याः । ८ ह्रींजयायै नमः । ९ महायोगिनी ।
 सुयन्त्रा, सुरूपा ।

षष्ठम(ष्टे)वलये तदुपरि पद्मावत्या हि पञ्चशतचेत्यः ।
 नानाभरणविभूषितगात्रा न्यस्याः सुरुपयुताः ॥४३॥
 सप्तमवलये देव्या दण्डेशा विंशतिस्त्वमीषां स्यात् ।
 प्रत्येकं परिवारस्तुर्यसहस्रो महासुभटः ॥४४॥
 देव्या अष्टमवलये द्वाःस्थः श्रीमाणिभद्रपरिवारः ।
 पञ्चसहस्रो वीरः संस्थाप्यो मन्त्रिभिर्गुरुतः ॥४५॥
 'पञ्चदशदशमवर्णैर हिताः क्षयुताश्च तत्र युक्तम्लर्यु' ।
 व्यञ्जनवर्णाः सृष्ट्या क्रमशः स्थाप्या ध्रुवं स्वस्थाः ॥४६॥
 वामेऽ'वामेधस्तान्मूर्ध्नि प्रत्यङ्गिराम्बिका ज्वाला ।
 चक्रान्तनमो विधिना श्रीमायाकामबीजमुख्याश्च ॥४७॥
 रवि-शशि-मङ्गल-बुध-गुरु-शुक्र-शनैश्चर-राहु-केत्वाख्याः ।
 'तेजस्त्रिमूर्तिपूर्वान्तनमोऽधस्तान्नव ग्रहाः क्रमशः ॥ ४८ ॥
 वाग्बीजकश्रीतत्त्वाद्यान्तनमः स्युस्त्वनन्तवासुकिनो' ।
 तक्षक-कर्कोटक-कमल-महाकमल-शङ्ख-कुलि-जयास्तदधः ॥ ४९ ॥
 श्रीइन्द्रनन्दिमुख्या गुरवः स्थाप्याः क्रमेण तदधस्तु ।
 निजगुरुकथिताः शिष्यैरवलम्बितमौनमतिनिपुणैः ॥ ५० ॥
 संस्थाप्यैवं मण्डलमथेप्सितासनसमाश्रितो ध्यायेत् ।
 दन्तैर्दन्तान् बहुशस्त्वसंस्पृशन्निति महामन्त्री ॥ ५१ ॥
 नाभ्युद्गताष्टपत्रककमलप्रान्तस्थितां सुधाशुद्धाम् ।
 त्रिफणाहिभूषिततमस्फारशिरस्कां शुभाङ्गधराम् ॥ ५२ ॥
 पद्माङ्कुशवरपाशकसम्भूषितभुजचतुष्टयां हृष्टाम् ।
 अम्भोजासनसंस्थां श्रीपद्मां देवतां स्थिरधीः ॥ ५३ ॥
 शुभ्राम्बरपरिधानां दन्तच्छेदाभहंससंरूढाम् ।
 ध्यानविधानेनान्तः श्रीपद्मां देवतां स्थिरधीः (ध्यायेत्) ॥ ५४ ॥
 चतुर्भिः कलापकम् ।
 पञ्चोपचारपूजामस्येति करोतु चाह्वानम् ।
 स्थितिसन्निधिकरणे द्वे पूजां विसर्जनं प्राहुः ॥ ५५ ॥
 आदिमबीजाद् देव्याः सम्बोधनमेहि पद्मि संवौषट् ।
 आह्वाननमिदममुना मन्त्रेण करोतु कुसुमाद्यैः ॥ ५६ ॥

१ णञौ वर्जयित्वा । २ दक्षिणे । ३ ॐ हौं क्लौं प्रत्यङ्गिरायै नमः । ४ ॐ हौं रवये नमः
 इतिग्रहस्थापना । ५ ॐ श्रीं हौं वासुकिने नमः ।

तिष्ठद्वितयं दान्तद्वन्द्वं तु स्थितिकृतौ समारचतु ।
 मम सन्निहिता भव भव वषडिति योज्यं च सन्निधीकरणे ॥ ५७ ॥
 पूजादीन् गृह्ययुगं नम इति पूजाविधानके तद्वत् ।
 स्वस्थानं गच्छयुगं यस्त्रितयं त्वयि विसर्जनके ॥ ५८ ॥
 पूरकरेचकयोगेऽमृतमाह्वानं विसर्जनं च तथा ।
 पूजाभिमुखीकरणस्थापनसमये च कुम्भकं योगे ॥ ५९ ॥
 मन्त्रो येषां यो यः स्यात् तेषां तेन तेन पूजादि ।
 कर्मास्मिन् मण्डलके क्रमशः कार्यं ध्रुवं विधिना ॥ ६० ॥
 सञ्जप्य लक्ष्मेकं पुष्पैर्जात्यादिभिः सदा ब्रह्म ।
 भूशय्यैककभोज्यः संस्नातो धौतसद्वस्त्रः ॥ ६१ ॥
 सदशांशजापकुसुमैर्घृतमधुगुग्गुलसधूपको ह्योमः ।
 मन्त्रोच्चारान् नीचैर्दिकूपत्राम्भोजसमकुण्डे ॥ ६२ ॥
 क्षीरद्रुममयसुसमित्प्रवर्द्धितानम्भकलवह्नौ ।
 देयो निर्मलचित्तैर्मन्त्रिभिरत्यन्तकृतरक्षैः ॥ ६३ ॥
 सत्येवं श्रीपद्मा प्रत्यक्षीभूय राज्यमतिविपुलम् ।
 नानासिद्धिसमेतं ददाति नियतं क्षणादेव ॥ ६४ ॥
 भूतोरगवेतालाः करालकङ्कालकालयोगिन्यः ।
 उरलकसहजाद्यशुभास्त्रसन्ति तद्दृष्टिविक्षेपात् ॥ ६५ ॥
 चिन्तितनार्याकृष्टिश्चिन्तितरिपुवर्गमारणोच्चाटम् ।
 चिन्तितशान्तिक-पौष्टिकमिहापि वचनैर्भवेत् तस्य ॥ ६६ ॥
 अनुदिनमतिभक्त्या मण्डलं यः स्वशक्त्या द्विनवकुसुमषट्कैरर्चयेन्मासषट्कः ।
 किमिह बहुभिरुक्तैः सारसीमाविरक्तैः स्मरति यदपि कामं स्यात् करे तत् प्रकामम् ॥

इति श्वेताम्बरचक्रचूडामणिश्रीयशोभद्रोपाभ्यायशिष्य-
 चन्द्रप्रकाशितेऽद्भुतपद्मावतीकल्पे देव्यर्चनाक्रम-
 सयन्त्रलक्षणं चतुर्थम् ।

श्रवणचरणचक्षुःपाणिनासाप्रशस्तं
 द्वितयकुलविशुद्धं षट्कवर्षप्रमाणम् ।
 सुरभिजलपवित्रं श्वेतसद्वस्त्रयुक्तं
 कुसुममलयजाद्यैर्भूषि पात्रं प्रशस्तम् ॥ १ ॥
 अतिशयितकुरूपं छिन्नकर्णादिरूपं
 कुकुलमधमभावं रूक्षकान्तिप्रभावम् ।
 अरुणगुलिकवस्त्रं गात्रदेशाङ्गसंस्थं
 भवति हि तदपात्रं मण्डले दुष्टपात्रम् ॥ २ ॥
 मलयजरसलिप्ते शुद्धपात्रस्य भाले
 वदनपरिधि युक्त्या ^१तत्त्वरेखात्रियुक्ते ।
 चरण युगलकाधो न्यस्यते तस्य यन्त्रं
 विमलखटिकयैतत् सद्गुरुद्दिष्टयुक्त्या ॥ ३ ॥
^२त्रिवलितमदनान्तोऽधोमुखेन्दुप्रखण्ड-
 विवरविहिततत्त्वं दिक्षु न्यस्तं तदेव ।
 इति कृतवति पश्चान्नागवल्लीदलान्त-
 लिखितविमलचूर्णाग्रथादिमन्त्रेण युक्तम् ॥ ४ ॥
 शुभसुरभितपूगं दीयते तस्य मन्त्रात्
 तदनु जलशभास्यं मण्डलस्याग्रतःस्थम् ।
 स्तुतिरचितसमूहैर्वर्ण्यते तत्र देवी
 विहितविशदमुद्रा मन्त्रिणोच्चैर्यथावत् ॥ ५ ॥
 जैने पद्मावतीति त्वमशुभदलना त्वं च गौरीति शैवे
 तारा बौद्धागमे त्वं प्रकृतिरिति मता देवि ! साङ्ख्य्यागमे त्वम् ।
 गायत्री भट्टमार्गे त्वमसि च विमले कौलिके त्वं च वज्रा
 व्याप्तं विश्वं त्वयेति स्फुरदुख्यशसे मेऽस्तु पद्मे ! नमस्ते ॥ ६ ॥
 पातालं हुंकृतेन प्रबलबलयुजा देवि ! भित्वाशु पीत्वा
 पीयूषं सप्तसप्तिप्रभवकरखरं क्षमातलं चेत्यमानः ।
 ॐ आँ क्रौँ मन्त्रमूर्ते ! कुरु झटिति महाक्षुब्धहृत्तारिचक्रे !
 सद्यः पात्रं सशोभं चटुलकरशिरःकेशपाशप्रचण्डे ॥ ७ ॥

चण्डी चण्डीशदंष्ट्राक्रकचसमलसत्क्ररपाशक्षतारे !
 तारे ! तारावतारे ! विदलितदितिजे ! देवि ! पद्मे ! सुपद्मे ! ।
 ह्रीं ऐं ह्रीं मन्त्ररूपे ! चलचपलकरे ! शीघ्रमेहोहि दुर्गे !
 दुष्टः कः स्थातुमग्रे तव भवतु वरे ! हुंहुकारं वहन्त्याः ॥ ८ ॥
 ॐ ह्रसैकारान् सविन्दौ द्रुतदृढविषमव्याधिबाधातिमुद्रे !
 हुं हुं हुं हुं हुं हुमष्टादशविविधमहादोषमुद्रां प्रहृत्य ।
 श्रीपद्मे ! देवि ! वेगाद् वपुरमलमलं कम्पि कम्पि प्रकम्पे !
 ह्रीं ऐं मातः सुरूपे ! परपरमगते ! मेदि मेदि प्रभद्रे ! ॥ ९ ॥
 पातालं क्षोभयन्ती धरणितलमलं कम्पयन्ती सुवेगाद्
 ब्रह्माण्डं स्फोटयन्ती जलधिजलचरध्वानरुद्रातिभीमम् ।
 भागच्छागच्छ देवि ! द्रुतमतुलगुणे ! गौरि ! दुर्गे ! सुवर्गे ! ।
 ह्रींकारान् मेदय द्राग् धगधगधमिते सार्द्धरोमत्रिकोटि ॥ १० ॥
 अव्यक्ते ! व्यक्तरूपे ! परमसुखकरे ! हंसपृष्ठाधिरूढे !
 सोत्सेके ! निष्कलङ्के ! कलितकलिमले ! ध्वस्तमुद्रेऽस्ततन्द्रे ।
 नित्ये ! ऽनित्ये ! सुरूपे ! कृतसमयमुखे ! भिन्दि भिन्दि प्रभिन्दि
 क्लैं दोषान् बन्ध बन्ध प्रवररवपरे ! देवि ! दुष्टान् समस्तान् ॥११॥
 श्रीपद्मे ! देवि ! भीमे ! भवभयदलने ! क्रूरनेत्रे ! सुगात्रे !
 सश्रीके ! कामरूपे ! परमतदमने ! रक्तनेत्रे ! त्रिनेत्रे ! ।
 निःशङ्के ! क्रूरजिह्वे ! रररररमते ! ऽट्टट्टहासे ज्वलन्ती
 ॐ ॐ मन्त्राणि दोषे दह दह दहने क्षोभय क्षोभय द्राक् ॥ १२ ॥
 रे रे रे रे क्व दोषा डरलकसहजा जाततूर्णं सदूरं
 चण्डोऽयं बाहुदण्डः स्फुरति परमदद्रावणो वः पुरस्तात् ।
 नो चेदुच्चैश्च चञ्चद् यययययजाकारमुच्चार्थं देवी
 युष्मानेकाररूपा भृतभृकुटिघटा पश्यतैषा क्षणोति ॥ १३ ॥
 भो ! भो ! कोटिगयक्षा शुभविविधमरुद्व्यन्तरोच्छिष्टदैत्या
 रक्षश्चण्डालचण्डग्रहगमनपयोभूमिगोत्रादिदेव्यः ।
 दूराद् दूरं प्रदेशं भजत निजममुं बीजमादाय तूर्णं
 नो चेत् घृत्खम्भमूर्ध्वं झटिति पट्टभटा स्थाणुमादाय वाञ्छम् ॥ १४ ॥
 एकैकं देवि ! बीजं तव मुहुरनयं विघ्नसङ्घातघाति
 यो यः सद्बिन्दुभक्त्या स्मरति करं...सक्रमं व्यक्रमं वा ।
 मातश्चारुच्चवीचीचलदुदधिलसद्मल्लरी.....पत्रे
 स्फूर्जच्छेषाहिदण्डे सससुरमहितः स्वर्णकुम्भायितधीः ॥ १५ ॥

श्रीमदिन्द्रनन्दिमन्त्रवादिविद्याचक्रवर्तिचूडामणि करी आज्ञा देवि !, गुरु तणी आज्ञा देवि !, परमगुरु तणी आज्ञा देवि !, भट्टारक श्री पार्श्वनाथ करी आज्ञा देवि !, सप्त पाताल फोडिउ, नव नागकुंडि अमृतपान करी आवियइ वेगिइ देवि !, देवि ! स्तम्भिनि !, देवि ! मोहिनि !, देवि ! दीपनि !, देवि ! दुष्टशोषकि !, देवि ! दोष-निर्दलनि !, देवि ! द्वादशादित्य करउ तेजु, अगण्यपुण्यदाक्षिण्यनैपुण्यनिधि ! देवि ! अविचलवाचा युधिष्ठिरि !, देवि ! जिनशासनोद्धारकि !, देवि ! भट्टारक श्रीपार्श्वनाथ भक्तानुभक्ति !, देवि ! कृपाकारकि !, देवि ! सुस्फुरि !, देवि ! प्रज्ञानिवहिकि, देवि ! ॐ आं क्रीं मन्त्रमूर्ते !, देवि ! पद्मावति !, ध्वनि ध्वनि कंपि कंपि ह्रींकारेण गात्रं चालि चालि, बाहुं चालि चालि, शीर्षं चालि चालि, साङ्गोपाङ्गि हि चालि चालि, कटि कटि कम्पि कम्पि कम्पावय कम्पावय आवेशय आवेशय हसैँ मण्डलमध्ये प्रवेशय प्रवेशय यदिगत इन्द्रान् आणि आणि रुद्रलोकान् आणि आणि पातालात् आणि आणि ह्रीं षँ अहूठ कोडि रोमराइ मेदि मेदि ।

तदनु सुरभिपुण्यैरक्षतैः सारधूपै-

रगुरुमलयजाद्यैर्मध्यमध्यं समन्त्रैः ।

इति कृतवति पश्चात् पृच्छयते स्वेष्टकार्यं

यदपि वदति वाक्यं तद् भवत्येव सत्यम् ॥ १६ ॥

विविधमन्त्रविदः कृतरक्षकाः

प्रविदधत्यति ये किल मन्त्रिणः ।

प्रवरवेव्यघतारविधिक्रमं

भुवि त एव मुदं प्रवहन्त्यलम् ॥१७॥

इति श्रीश्वेताम्बरचक्रचूडामणिश्रीयशोभद्रोपाध्याय-

शिष्यचन्द्रप्रकाशितेऽद्भुतपद्मावतीकल्पे

पात्रविधिलक्षणं पञ्चमम् ॥ ५ ॥



ह्रंकारं प्रणवद्वयेन पुटितं तन्नामगर्भं बहि-
 वेंष्टयं षोडशभिः कलाभिरभितो भिन्नं च वज्राष्टभिः ।
 तत्प्रान्तः क्षह्र भाममान्तरशषाल्लूयं युतास्तत्पुर-
 श्चेत्येतत् सकलं त्रिमुष्टिकुशतः कांस्ये न्यसेच्चन्दनैः ॥ १ ॥

ॐ ह्रीं श्रीं वदने नमस्तु निधने ! मध्ये तथाऽर्हत्कलि-
 कुण्डस्वामिन एष मन्त्र उदितो जप्त्वा शतं कौसुमम् ।
 भूतप्रेतपिशाचशाकिनिपरिच्छेदः प्रसूतिः स्त्रियः
 स्याद् दृष्टे कलिकुण्डदण्डपटले शान्त्यादि कार्यं पुनः ॥ २ ॥

मान्तं पिण्डमधः खकुक्षिषु गतं नाम्नः कलावेष्टितं
 ह्रींक्रौंमाद्यवसानरेखि लिखितं भूर्ये त्रिधा वेष्टनात् ।
 दोषालं शिलयाथ पीतकुसुमैरौ गैलौ ठ एवं शतं
 जप्त्वैतत् शिलया सिहारिकभयप्रध्वंसि खे भारितम् ॥ ३ ॥

रररररररग्नेः सत्पुरान्तःस्थं ह्रं क्षूं
 त्रिकटनिधनवर्णे भित्तिन्यस्ते समस्ते ।
 शुभसुरभिभिरर्चाभाजिते यत्र तत्र
 न भवति भयमुच्चैः सिद्धहार्यास्तदादि ॥ ४ ॥

रेखासप्तविपाटितान्तररवे रेखाष्टभिर्भेदितं
 दुष्टं टान्तयुगं बहिः सुविधिना तेजोऽष्टधा प्रान्तरे ।
 तन्मूर्ध्न्यग्निरसानभोजलमरुन्मान्तत्रिठः पञ्च हुं
 फट् स्वाहाक्रमतो हिमादिखटिकाभूर्जस्थयन्त्रं कुरु ॥ ५ ॥

धवलसुरभिपुष्पैर्ध्यानयुक्तोऽपि यस्तु
 द्विनवकरससङ्घैरर्चयेद् यत्र तत्र ।
 भवति हि परमुद्राच्छेद आश्वेव तस्य
 यदि नहि पचिमेदः शान्तये स्यात् तदा तत् ॥ ६ ॥

ॐ क्षिहा प स्वाहा यः यः यः ठः ठः ठः स्फ्राँ स्फ्रीँ स्फ्रुँ स्फ्रौँ स्फ्रीँ स्फ्रः हुं
 फडित्याम्नायः ।

अन्यत्रैवमियं विद्या गतिगर्भादिकीलने ।
 गन्धदीपप्रसूनादिपूजिता सन्नियोजयेत् ॥ ७ ॥

ऊर्ध्वाधो रयुतं जकारसहितं इलं (इलं) कारबीजं लिखे-
देँ ह्रीं ग्रामथ ह्रँ फडग्निपुटके नाम्ना युतं तद्वहिः ।
संन्यस्तं वसुवायुमण्डलगतं कुण्डेऽथवा पट्टके
पश्यन्तं नरमश्वगन्धयवकैर्मन्त्रेण चात्रोटयेत् ॥ ८ ॥

मन्त्रः—

ॐ ह्रँ सः वं क्षः क्ष्म्लँर्युँ ह्रौँ ह्राँ ग्राँ हुँ फट् ॐ स्वेँ झ्राँ झ्रीँ
शाकिनीनां निग्रहं कुरु कुरु हुं फट् ॥ ९ ॥
सत्येवं प्रलयं यान्ति शाकिनीभूतराक्षसाः ।
भूर्जस्थयन्त्रं रक्षेयं हन्ति तां कुङ्कुमादिभिः ॥ १० ॥
पुष्पाणि गुग्गुलं वापि क्रममन्त्रेण मन्त्रिणा ।
दोषस्य पुरतः पूर्वं वह्निना सम्प्रदर्श्यते ॥ ११ ॥
तत्परिमलमाघ्राय शाकिन्याद्यास्त्रसन्त्यलम् ।

मुक्ता तदेव पात्रं च यान्ति ते दोषसङ्कराः ॥ १२ ॥
क्ष्वीँफट् लीँफट् श्रीँफट् क्लीँफट् झूँफट् ह्रूँफट् क्षूँफट्
स्वाहा । पुष्पमन्त्रः ॥ १३ ॥

ॐ ग्राँ ग्राँ ग्राँ ग्राँ ग्राँ झ्राँ झ्राँ झ्रीँ झ्रीँ झ्रीँ हं हं ह्रँ ह्रँ ह्रँ
रौँ रौँ रौँ सः सः गुग्गुलमन्त्रः ॥ १४ ॥
निखिलमथ विधानं पूर्ववद् दोषपात्रे

त्वरुणकुसुममालाक्षेप एव प्रमेदः ।
तदनु वधनमेदाद्यत्र कार्यं हि कार्यं
निजकनिजकमन्त्राच्चेति सर्वं तथेति ॥ १५ ॥

झूँ झूँ झूँ झूँ झूँ झूँ झूँ झूँ । शस्त्रिकाघातः ।

बापुलाजाल चलसि महिकाल एति गल तोडि, दहि सुहि गांठि बोडि, थां
गां था तोडि, जेण समुद्र पगारिआ अगुरु किलकिलाइ उक्खिल्लि हनुमन्त ! प्रचण्ड
दांडीक पाणि ! नास्ति दोसु नास्ति दश य दिशि बांधि बांधि आपणा पायतलि घालि
हनुमन्त ! प्रचंड दांडीकपाणि ! बांधि बांधि जः जः जः आँ अघोराय नमः रौँ फट्
स्वाहा । इति बन्धमन्त्रः ।

ॐ ह्रीँ छिन्दि छिन्दि भिन्दि भिन्दि माणिभद्र ! चेटकमाकर्षय आकर्षय मारय
मारय चूरय चूरय ह्रँ फट् स्वाहा । दोषपात्रावतार-परविद्याच्छेदनमन्त्रः ।

ॐ नमो भगवते पार्श्वनाथाय पद्मावतीसहिताय धरणोरगेन्द्रनमस्कृताय सर्वो-
पद्रवविनाशनाय परविद्याच्छेदनाय परमन्त्रप्रणाशनाय सर्वदोषनिर्दलनाय आकाशान्
बन्ध बन्ध, पातालान् बन्ध बन्ध, देवान् बन्ध बन्ध, दैत्यान् बन्ध बन्ध, गणान् बन्ध

बन्ध, कल्मलग्रहान् बन्ध बन्ध, उच्छिष्टग्रहान् बन्ध बन्ध, चण्डालग्रहान् बन्ध बन्ध, भगवन् ! क्षेत्रपाल ! ग्रामं बन्ध बन्ध, यक्षान् बन्ध बन्ध, राक्षसान् बन्ध बन्ध, शाकिनीं बन्ध बन्ध, डाकिनीं बन्ध बन्ध, लाकिनीं बन्ध बन्ध, जाकिनीं बन्ध बन्ध, गृहीतमुक्तकां बन्ध बन्ध, दिव्ययोगिनीं बन्ध बन्ध, वज्रयोगिनीं बन्ध बन्ध, खेचरीं बन्ध बन्ध, भूचरीं बन्ध बन्ध, नागान् बन्ध बन्ध, वर्णराक्षसान् बन्ध बन्ध, झोर्टिगान् बन्ध बन्ध, मुद्गरग्रहान् बन्ध बन्ध, व्यन्तरग्रहान् बन्ध बन्ध, आकाशदेवीं बन्ध बन्ध, जलदेवीं बन्ध बन्ध, स्थलदेवीं बन्ध बन्ध, गोत्रदेवीं बन्ध बन्ध, एकाहिक-द्वयाहिक-त्रयाहिक-चातुर्थिक-नित्यज्वर-रात्रिज्वर-सर्वज्वर-मध्याह्नज्वर-बेलाज्वर-वातिक-पैत्तिक-प्रलेप्पिक-सान्निपातिक-सर्वदोष-देवकृत-मानवकृत-यन्त्रकृत-कार्मणकृत उच्छेदय उच्छेदय, विस्फोटय विस्फोटय, सर्वदोषान् सर्वभूतान् हन हन, दह दह, पच पच, भस्मी कुरु कुरु ।

॥ मालामन्त्रः ॥

अथवा—

ॐ नमो भगवते हनुमन्ताय कपिललोचनवज्राङ्गमुष्टे ! उदधिलङ्घन-लङ्कापुरीदहन-दीपन-मथन ! सुग्रीवसैन्यभूषण ! अञ्जनासुत ! सर्वोपकारिन् ! बालब्रह्मचारिन् ! आकाशान् बन्ध बन्ध, इत्यादि पूर्ववदयं मालामन्त्रः । यथोक्तञ्च ।
तथा मालामभिमन्त्र्य दोषपात्रे क्षेपकञ्चेति ।

ॐ नमो भगवते पार्श्वनाथाय दुष्टान्तकमठकरिकुम्भनिशुम्भनोत्तालकलकण्ठीरघाय गरीष्ठदुष्टाष्टकर्मकाष्ठनिष्ठापनहुताशनवरिष्ठाय असारसंसारपारावारोत्तारणतरण्डाय चतुर्स्त्रिशदतिशयालंकृतगात्राय तच्चरणसरोजाश्रयविशारदे ! देवि ! विदलिताशेषशत्रुसमुदये ! पद्मवदने ! पद्मे ! सपद्मे हंसपृष्ठाधिरूढे ! फलवरदपाशकाङ्कुशचतुर्भुजे ! देवि ! भैरवे ! भैरवरूपावतारे ! तारे ! तारावतारे ! देवि ! रौद्रे ! रौद्रलोचनावतारे ! कालव्यालवेतालकरालकङ्कालभूतप्रेतपिशाचयक्षराक्षसगणगन्धर्वकिन्नरोरगेन्द्रग्रहनिग्रहैकोद्यतभुजे ! भीमे ! भीमाट्टहासभीषितानन्तबलद्विपञ्चाशत्क्षेत्रपालचण्डचतुरशीतिचेटकोद्भटविकटसार्द्धद्विकोटिभूतावलिमानमुद्रे भद्रे ! भद्रावतारे ! भद्रमूर्ते ! निर्दलिताशेषतन्द्रे ! जय जय जयोद्यते ! देवि ! विकटहुंकारविपाटितसप्तपातालच्छदने ! खण्डितचतुःषष्टियोगिनीसुदढमुद्रातिवर्गे ! नवनागकुण्डअमृतपानोत्साहोच्छेकप्रकम्पिताशेषब्रह्माण्डोदरे ! तत्कालोच्छलितज्वलज्ज्वलित-कलकलितनिखिलसलिलनिधिचलचपलमकरमत्स्यकच्छपप्रभृतिव्याकुलानन्तसत्त्वघोरारवस्फुटद्रगनाभोगभागे ! स्फारफुत्कारदारुणत्रिफणाहिविषमविषज्वालानिर्दग्धहिंस्नाहङ्कारे ! देवि ! गुणवति ! पद्मावति ! दुःखसागरोत्सारणि ! सर्वदुरितापहारिणि ! यमजिह्वाकरालरूपधारिणि ! चिन्तितचिन्तामणे ! अरुणे ! अमरे ! अमरावतारे ! अकले ! सकले ! निष्कले ! निर्मले ! देवि ! अजिते ! अपराजिते ! ए पैकारमूर्ते ! स्वर्ग-मर्त्य-पातालविवरवर्तिनो दुष्टातिदुष्टान् पुंस्त्रीविभेदान् दोषान्

वच्छुकारशब्देन देवि ! पात्रेऽवतारय अवतारय भारसहस्रशृङ्खलाबन्धेनात्मपादतले
 क्षेपय क्षेपय लोलय लोलय घूर्मय घूर्मय चालय चालय क्षोभय क्षोभय आँ क्रौं ह्रीं-
 काररूपे ! देवि ! श्रीमति ! पद्मावति ! ऐंक्लैँकारसबले ! घोलय घोलय दोलय दोलय
 उच्छालय उच्छालय लोटय लोटय वज्रमयसूच्यानेत्राणि स्फोटय स्फोटय अङ्कुशेनान्त-
 राले सहस्रधा त्रोटय त्रोटय नागपाशेन सर्वाङ्गं मोटय मोटय भञ्जय भञ्जय ॐ ज्वाला-
 जिह्वाकराले ! ररररर मूर्ते ! सर्वाङ्गं दह दह सर्वधातून् क्षोभतां नय नय परमुद्रां
 त्रोटय त्रोटय आत्ममुद्रां देहि देहि ह्रसैँकारेण देवि ! मनोवाञ्छितं कार्यं कुरु कुरु, डा-
 किनीजाकिनीकन्दकुहालिनि ! राकिनी-लाकिनी-मानमर्दनि ! हाकिनीजाकिनीकुलोच्छे-
 दिनि ! ह्रीं जय जय ॥ यथोक्तमन्त्रः ।

द्विकचान्तरातहादिमझाद्यदिशिरकहकूटयुताः ।

ॐ अःयुक्ताः क्रमशः स्थाप्या दिग्वर्गयन्त्रेऽथ ॥

तत्परितो वह्निपुरं ह्रींक्रोमाद्यन्तरेखया वेष्टयम् ।

पतत्सकटिकनिहितं दोषच्छेदाय हृतये मन्त्रान् ॥

मन्त्रः—

ॐ नमो रुद्राय वानरराजाय हन हन दह दह मथ मथ बन्ध बन्ध भूतल भूतल
 ह्रीं ह्रँ ह्रँ ह्रँ हे हे हे ह ह काटय काटय मद मद मोचय मोचय अबन्धप्रहे चक्रे !
 चाटुवास्वले वाहर वाहर स्वाहा । मन्त्रितमालाया दोषाकृष्टिः ।

अथवा—

सुदर्शनतो मन्त्राद् विदधातु चित्तमनुकृत्यम् ।

येन स्मरणविधिना कृत्याकृत्यं हि हस्तगतम् ॥

हीहोरीसणरीसो अदमदपुरिसो डगमगचरितो । उठी दक्षिणदिशां महादिव
 किलिकिलिशब्दं झंकाररूपि अहमदचक्रि छिन्नि मदासणि छिन्नि अहमदसामिणि छिन्नि
 छिन्नि, कावाडंकी छिन्नि छिन्नि होही होरी सणसो विसनासण हरि च्छिन्नि सुदरिसण ॥

त्रिसन्ध्यमाराध्य सुरक्तपुण्यैः

सप्तैव सप्तैव दिने दिने (?) यावद्

दिनानि भवन्ति भवन्ति सप्त

सिद्धो भवेत् सर्वकार्यकरस्तथायम् ॥

इति श्रीश्वेताम्बरचक्रचूडामणिश्रीयशोभद्रो-

पाध्यायशिष्यचन्द्रप्रकाशितेऽद्भुतपद्मा-

वतीकल्पे षष्ठं दोषलक्षणं

समाप्तम् ॥ ६ ॥

परिशिष्ट २
श्रीइन्द्रनन्दिविरचितं
श्रीपद्मावतीपूजनम् ।

ॐ नमो भगवते पार्श्वनाथाय ह्रींपद्मावतीसहिताय धरणोरगेन्द्रसहिताय सर्वोपसर्ग-
विनाशकाय परविद्योच्छेदकाय परमन्त्रविनाशनाय परदोषनिर्दलनाय आकाशान् बन्ध
बन्ध, राक्षसान् बन्ध बन्ध, पातालान् बन्ध बन्ध, देवान् बन्ध बन्ध, दैत्यान् बन्ध
बन्ध, गणान् बन्ध बन्ध, उच्चिष्टान् बन्ध बन्ध, क्रमलान् बन्ध बन्ध, चण्डालसहान्
बन्ध बन्ध, क्षेत्रपालान् बन्ध बन्ध, ग्रहान् बन्ध बन्ध, यक्षान् बन्ध बन्ध, राक्षसान्
बन्ध बन्ध, शाकिनीः बन्ध बन्ध, याकिनीः बन्ध बन्ध, डाकिनीः बन्ध बन्ध, ग्रहभुक्त-
कान् बन्ध बन्ध, दिव्ययोगिनीः बन्ध बन्ध, खेचरीः बन्ध बन्ध, भूचरीः बन्ध बन्ध,
नाथान् बन्ध बन्ध, वर्णराक्षासान् बन्ध बन्ध, कोटिकान्तान् बन्ध बन्ध, पुद्गलग्रहान्
बन्ध बन्ध, आकाशदेवीः बन्ध बन्ध, जलदेवीः बन्ध बन्ध, स्थलदेवीः बन्ध बन्ध,
गोत्रदेवीः बन्ध बन्ध, एकाहिकं बन्ध बन्ध, द्वयाहिकं बन्ध बन्ध, नित्यज्वरं बन्ध बन्ध,
तृतीयज्वरं बन्ध बन्ध, सर्वज्वरं, वेलाज्वरं, मध्याह्नज्वरं, वात-पैत्तिक-श्लेष्मिक-सान्नि-
पातिक-सर्वदेवकृत-मानवकृत-मन्त्रकृतं कार्मणं उच्छेदय, विस्फोटकान् सर्वदोषान् सर्व-
भूतान् हन हन, दह दह, पच पच, भस्मीकुरु कुरु स्वाहा । पतन्मालामन्त्रः ॥

अथ गुरुपादुकाकारपर्यन्तः पूजाक्रमः ।

प्रथमं भूमिशुद्धिः—

अथ मन्त्रस्थापनपूर्वकं आत्मनः सकलीकरणं कार्यम् ।

ॐ अमृते ! अमृतोद्भवे ! अमृतवर्षिणी अमृतं स्नावय स्नावय स्वाहा । वार १०८
दिकलशमन्त्रः ।

ॐ अरजे ! विरजे ! अशुद्धविशोधिनी मां शोधय शोधय स्वाहा । वार १०८
विदिशि दिकलशमन्त्रः ।

मायाबीजेन तिलकं कार्यम् । निजदेहे पञ्च तत्त्वबीजानि न्यसेत् ।

क्षिप ॐ स्वाहा अनुलोम विलोम वार ३

तत्त्वस्थापनम् ।

ॐ आँ हृदयाय नमः, ॐ क्रौं शिरसे स्वाहा. ॐ ह्राँ शिखायै वौषट्, ॐ आँ कवचाय हुं ॐ क्रौं नेत्राय वषट्, ॐ ह्रीं अस्त्राय फट्, करे अस्त्रं ध्रियते ॐ ह्रीं अस्त्राय फट् इति अङ्गन्यासः ।

ॐ आँ अङ्गुष्ठाय नमः, ॐ क्रौं तर्जन्यै स्वाहा, ॐ ह्राँ मध्यमायै वौषट्, ॐ आँ अनामिकायै हुं, ॐ क्रौं कनिष्ठिकायै वषट्, ॐ ह्रीं करतले, पृष्ठे फट् स्वाहा ।

इति करन्यासः ।

अस्त्रमन्त्रेण अर्घपात्रपूजा, द्रव्यप्रोक्षणं च । स्वाङ्गपूजा मूलमन्त्रेण । ॐ ह्रीं परेभ्यो गुरुपादुकाभ्यो नमः, अपरापरेभ्यो गुरुपादुकाभ्यो नमः ।

इति गुरुपङ्क्तिपूजा ।

ॐ आँ ह्राँ क्रौं नित्ये ! नमः, ॐ आँ क्रौं ह्राँ किलन्ने ! नमः, ॐ आँ क्रौं ह्राँ मदे ! नमः, ॐ आँ क्रौं ह्राँ उन्मादे ! नमः, ॐ आँ क्रौं ह्राँ द्रवे ! नमः । ॐ आँ क्रौं ह्राँ द्रावे ! नमः, ॐ आँ क्रौं ह्राँ मातुलिङ्गाय नमः, ॐ आँ क्रौं ह्राँ वरदाय नमः, ॐ आँ क्रौं ह्राँ ह्रीं क्लीं ब्लूं सः पञ्चबाणाय नमः । ॐ आँ क्रौं ह्राँ अङ्गुशाय नमः, ॐ आँ क्रौं ह्रीं धनुषाय नमः । इति भोगागलमागादिस्थापना ।

श्रीपूर्णगिरिपीठं श्रीकुमारदेउपीठ, श्रीकुमारदेउ सन्मुख

इति पीठस्थापना ।

ॐ क्षाँप नमः वार ३ पठित्वा पुष्पं मुच्यते ।

अथाह्वानबीजम्—

ॐ नमो भगवति ! देवि ! पद्मे अत्र सन्निहिता भव, अत्र तिष्ठ तिष्ठ, पूजां गृण्ह गृण्ह स्वाहा ।

ॐ पद्मगन्धायै आगच्छ आगच्छ पूजां गृण्ह गृण्ह स्वाहा ।

ॐ पद्मवक्त्रायै आगच्छ आगच्छ पूजां गृण्ह गृण्ह स्वाहा ।

ॐ ह्रीं पद्मकमलायै आगच्छ आगच्छ पूजां गृण्ह गृण्ह स्वाहा ।

ॐ ह्रीं मदनोन्मादिनी आगच्छ आगच्छ पूजां गृण्ह गृण्ह स्वाहा ।

ॐ ह्रीं कामोद्दीपनी आगच्छ आगच्छ पूजां गृण्ह गृण्ह स्वाहा ।

ॐ ह्रीं पद्मवर्णायै आगच्छ आगच्छ पूजां गृण्ह गृण्ह स्वाहा ।

ॐ ह्रीं त्रैलोक्यमोहिनी आगच्छ आगच्छ पूजां गृण्ह गृण्ह स्वाहा ।

इति दूतिकाष्टकस्थापना ।

योगिनी ६४ स्थापना । पूजासिद्ध ८४ स्थापना । पद्मस्याधोभागे ॐ ह्रीं ८४ चेटका आगच्छ आगच्छ पूजां गृण्ह गृण्ह स्वाहा ।

चेटकपूजा ।

पद्मस्योत्तरपार्श्वे ॐ ह्रीं सिद्धचामुण्डा तथा सिद्धविनायक ! आगच्छ आगच्छ पूजां गृह्ण गृह्ण स्वाहा ।

पद्मस्य दक्षिणभागे ॐ ह्रीं आँ क्रौं ह्रीं क्षाँ क्षीं क्षूँ क्षैँ क्षः क्षेत्रपालाः सपरिकराः आगच्छन्तु आगच्छन्तु पूजां गृह्णन्तु गृह्णन्तु स्वाहा ।

पद्मस्यैशानीं समाश्रित्य ॐ आँ क्रौं ह्रीं अष्टाविंशतिनक्षत्राणि अधिपसहितानि सपरिकराणि आगच्छन्तु आगच्छन्तु पूजां गृह्णन्तु गृह्णन्तु स्वाहा । नक्षत्रपूजा ।

पद्मस्याग्नेयीं दिशमाश्रित्य ॐ आँ क्रौं ह्रीं आदित्यादिनवग्रहाः सपरिच्छदाः आगच्छन्तु आगच्छन्तु पूजां गृह्णन्तु गृह्णन्तु स्वाहा ।

पद्मस्य नैर्ऋतकोणे देवीगोत्रसमुद्भवा ॐ आँ क्रौं ह्रीं क्षेत्रपाला आगच्छत आगच्छत पूजां गृह्णत गृह्णत स्वाहा ।

ॐ ह्रीं लं इन्द्राय, आगच्छ आगच्छ पूजां गृह्ण गृह्ण स्वाहा ।

ॐ ह्रीं णं आग्नेयाय आगच्छ आगच्छ पूजां गृह्ण गृह्ण स्वाहा ।

ॐ ह्रीं ऐं यमाय आगच्छ आगच्छ पूजां गृह्ण गृह्ण स्वाहा ।

ॐ ह्रीं नैर्ऋताय आगच्छ आगच्छ पूजां गृह्ण गृह्ण स्वाहा ।

ॐ ह्रीं वं वरुणाय । ॐ ह्रीं वायव्याय आगच्छ आगच्छ पूजां गृह्ण गृह्ण स्वाहा ।

ॐ ह्रीं लं कुबेराय आगच्छ आगच्छ पूजां गृह्ण गृह्ण स्वाहा ।

ॐ ह्रीं ह्रौं ईशानाय । ॐ ह्रीं ऊर्ध्वच्छदनाय । ॐ ह्रीं अधश्छदनाय । आगच्छ आगच्छ पूजां गृह्ण गृह्ण स्वाहा । इति दिक्पालपूजा ।

ॐ ह्रीं अजितायै पूर्वद्वारे प्रतिहारि आगच्छ आगच्छ पूजां गृह्ण गृह्ण स्वाहा ।
ॐ ह्रीं अपराजितायै आगच्छ आगच्छ । ॐ ह्रीं जयायै पश्चिमद्वारे प्रतिहारि ! आगच्छ आगच्छ । ॐ ह्रीं विजयायै उत्तरद्वारे प्रतिहारि ! आगच्छ आगच्छ पूजां गृह्ण गृह्णस्वाहा । इति प्रतिहारीपूजा ।

प्राकार आग्नेयकोष्ठाधिष्ठायिनी ॐ ह्रीं जंभा आगच्छ आगच्छ, नैर्ऋतकोष्ठाधिष्ठायिनी जंभा आगच्छ आगच्छ, वायव्यकोष्ठाधिष्ठायिनी ॐ ह्रीं थंभा आगच्छ आगच्छ, पद्मस्याधः पूर्वभागे ॐ आँ क्रौं ह्रीं मन्त्राधिष्ठायक ! आगच्छ आगच्छ । द्वितीयभागे ॐ आँ क्रौं ह्रीं चं यन्त्राधिष्ठायक ! आगच्छ आगच्छ निर्बीजयोनिमुद्रा १ सुरभिमुद्रा २ परमेष्ठिमुद्रा ३ करसम्पुटमुद्रा ४ अञ्जलिमुद्रा ५ मुद्रापञ्चकं दर्शयित्वा पुनर्देवी, पुनरङ्गे न्यासः, तर्पणम्, अर्थदानं, संपूजाक्रमः । देवीमन्त्रमुच्चार्य देव्या अङ्गपूजा तदक्षराणि संस्थाप्य ताः पूजनीयाः । सन्निहिता पञ्चबाणपूजा सबीजमुद्रापञ्चकं दर्शयित्वा आशिखाशिरसि विधाय क्षमयेत् । 'आज्ञाहीनं' ॐ नमो भगवति ! पद्मावति ! स्वस्थानं गच्छ गच्छ ह्रीं फट् । विसर्जनं वामकरेण संहारमुद्रया । अर्चनपुष्प आशिषं समुद्धृत्य स्वहृदि स्थापयेत् ।

परिशिष्ट ३

रक्तपद्मावतीकल्पः ।

ॐ ह्रीं क्लौं पद्मे ! पद्मावति ! महापद्मे । पद्महस्ते ! पौरान् क्षोभय क्षोभय, राज्ञः क्षोभय क्षोभय, प्रजाः क्षोभय क्षोभय, स्त्रीः क्षोभय क्षोभय, ह्रीं पद्मावति ! पायाः, पादुकापूजायां नमः ।

दिन ६३ त्रिषष्टिं यावत् रक्तपुष्प ६३ जापः । गुग्गुलगोली ६३ होमः, रक्ताञ्जनमय्यां कुङ्कुमलिखितायां वा पद्मावतीमूर्तौ बृहस्पतिवारेश्वरे घृत-दुग्ध-शर्करा-द्राक्षा-अक्षताः पञ्चाहुतयो देयाः ।

रक्तपद्मावतीपूजनविधिः—

पूग ४०, पत्र ४००, नालिकेर ४०, लाडु ४००, सितपत्र नवग्रहापात्री फूल १००, खाजा ४००, सुहाली ३५०, पञ्चधारलापसी माणा ५, द्राक्षा शेर १०, खारेक सेर ५, अखोड सेर १०, वारसोल ४००, साकरलिंगा ६४, टोपरां ६४, खांड सेर ५, केशर टांक ८, कर्पूर ग. २, कस्तूरी ग. १ गोलेवन ग. ३, सुखड सेर १०, रक्तकृष्ण सेलां २, आम्बादन पद्मावतीनी मूर्ति सुवर्णमय, जिनमुद्रा, दक्षिणा ६४, भाजन १ सुवर्णमय, फूल ९, शलाका रूप्यमय १, नव नैवेद्यानि पक्वान्नमयानि.

खाजां २१, खाजलां २१, लाडु २१, दहिथरा २१, सांकुली २१, मांडी २१, मरुकी २१, घूघरा २१, वांकुची २१,

नांदुलिया माणा २, नैवेद्यानि, पीचु माणा २, बाकुला सेर २१, कूर सेर २१, घूजा सेर २१, पूउली सेर २१, घेबर २१, वटक २१, करंबउ इति ।

कूपोदक घट १, उभयतटनी वेल्हू, दर्भ समूलु, कोरीबली—

चउला सेर १, चोखा सेर १, झाला सेर १, चणा सेर १, जव सेर १, तिल सेर १, जुगंधरी सेर १, मुद्ग सेर १, सप्त धान्यानि ।

अथ फलानि—

बीजोरु १, नालियर ४, केलां २१, दाडिम ३, आंबा २१, सेलडी २१, पञ्चामृत इत्यादि ॥

षट्कोणं मण्डलं चादौ षट्कोणषट्प्राकारान्वितं तद्बाह्ये द्विकर्णकस्योपरि अष्टदलं पद्म-
मालिख्य मायाबीजेन त्रिधा वेष्टयेत् । तद्बाह्यचतुःकोणप्राकार ईशानकोणे श्रीपार्श्वनाथस्य
प्रतिमा, आग्नेयकोणे पद्मावती चतुर्भुजा, नैर्ऋत्यकोणे ॐ अत्रस्थक्षेत्रपालाय नमः, वाय-
व्यकोणे पादुकायुग्मं विलिख्य ॐ ह्रीं गुरुपादुकेभ्यो नमः इति प्राकारान्तर्मण्डलबाह्य-
पूजाविधिः । ॐ आँ क्रौं ह्रीं नित्ये नमः पश्चिमकोणे १, ॐ आँ क्रौं ह्रीं मदे ! नमः !
ईशानकोणे २, ॐ आँ क्रौं ह्रीं द्रवे नमः अग्निकोणे ३, ॐ आँ क्रौं ह्रीं क्लिन्ने नमः वाय-
व्यकोणे ४, ॐ आँ क्रौं ह्रीं उन्मादे नमः पूर्वकोणे ५, ॐ आँ क्रौं ह्रीं द्रवे नमः नैर्ऋ-
त्यकोणे ६, इतिषट्कोणपूजा ।

ॐ ह्रीं मातुलिङ्गाय नमः दक्षिणे १, ह्रीं इस्कीं द्रां द्रां क्लीं ब्लूं बाणेभ्यो नमः
ईशाने २, ॐ ह्रीं आपसाय नमः पश्चिमे ३, ॐ ह्रीं वरदाय नमः उत्तरे ३, ॐ ह्रीं
क्रौं अङ्गशाय नमः आग्नेय्याम् ५, ॐ ह्रीं धनुषे नमः नैर्ऋते ६, इति षट्कोणान्तराल-
कर्णिकामध्यभूमिपूजा ।

ॐ ह्रीं जये स्वाहा १ पूर्वे, ॐ ह्रीं जम्मे स्वाहा २ आग्नेये, ॐ ह्रीं विजये स्वाहा
३ दक्षिणे, ॐ ह्रीं स्तम्मे स्वाहा नैर्ऋते ४, ॐ ह्रीं अजिते स्वाहा पश्चिमे ५, ॐ ह्रीं
स्तम्भिनि स्वाहा वायव्ये ६, ॐ ह्रीं अपराजिते स्वाहा उत्तरे ७ ॐ ह्रीं मोहे स्वाहा
ईशाने ८ इति पद्माष्टपत्रपूजा ।

ह्रीं ह्रीं हूं ह्रौं ह्रः वार ३ सकलीकरणम् ।

ॐ नमो भगवति ! देवि ! पद्मावति ! ह्रीं धूपं भज भज स्वाहा ।

ॐ नमो भगवति ! देवि ! पद्मावति ! ह्रीं गन्धादीन् प्रतीच्छ प्रतीच्छ स्वाहा ।

ऐं क्लीं ह्रस्रौं पद्मावति ! मम सर्वं जगद् वश्यं कुरु कुरु ह्रीं सं वौषट्, रक्तकण-
वीरपुष्पजापः सहस्र १० ततः सिद्धयति, वरदा भवति ।

इति पद्मावतीदेव्या द्वितीयचक्रविधानम् ।

ॐ ह्रीं पद्मावति ! पद्मनेत्रे ! मम शान्तिं कुरु कुरु स्वाहा । लक्ष १ जापः । सम्भवे
कमलपूजा । लक्षजापादनन्तरं दशांशेन होमः शैरेयी-खण्डसर्पिण्या । ॐ नमो भगवते
पार्श्वचन्द्राय त्रैलोक्यविजयालंक्रुताय सुवर्णवर्णधरणेन्द्रनमस्कृताय नीलवर्णाय कर्मका-
न्तारोन्मूलनमत्तमतङ्गजाय संसारोत्तीर्णाय प्राप्तपरमानन्दाय तत्पादारविन्दसेवाहेवाक-
चञ्चरीकोपमे ! मानवदेवदानवविनम्रमौलिमुकुटमण्डलीमयूखमञ्जरीरञ्जिताङ्घ्रिपीठे !

सेवकजनवाञ्छितार्थपूरणाधरीकृतचिन्तामणिकामधेनुकल्पलते ! विकसजपाकुसुमोदितार्क-
पद्मरागारुणदेहप्रभाभासुरीकृतसमस्ताकाशदिकृचक्रवाले ! लीलानिर्दलितरौद्रदारिद्र्योप-
द्रवे ! शरणागतत्राणकारिणि ! दैत्योपसर्गनिवारिणि ! भूतप्रेतपिशाचयक्षराक्षसाकाश-
जलस्थलदेवतादोषनिर्नाशिनि ! मातृमुद्गलचेटकोग्रग्रहणशाकिनीयोगिनीवृन्दवेतालरेवती-
पीडाप्रमर्दितपरविद्यामन्त्रयन्त्रोच्छेदिनि ! परसैन्यविध्वंसिनि ! स्थावरजङ्गमविषसंहारिणि !
सिंहशार्दूलव्याघ्रोरगप्रमुखदुष्टसत्त्वभयापहारिणि ! कासश्वासज्वरभगन्दरश्लेष्मवातपित्त-
कण्डूकामलक्षयोदुम्बरप्रसूतिप्रमुखरोगविध्वंसिनि ! चोरानलजलराजग्रहावच्छेदिनि !
एकाहिक-द्वाहिक-त्र्याहिक-चातुर्थिक-भौतिक-वातिक-सान्निपातिक-पैत्तिकज्वरोच्चाटिनि !
त्रिभुवनजनमोहिनि ! भगवति ! श्रीपद्मावति ! एहि एहि आगच्छ आगच्छ प्रसादं कुरु
कुरु । सर्वकर्मकरः श्रीपद्मावती-आह्वानस्तवोऽयम् ।

ॐ ऐं क्लीं ह्रस्वक्लीं ह्रीं ह्रसौं देवि ! पद्मावति ! नमः । ग्रहणदिने भूर्ये सुगन्धद्रव्यै
रक्षा कार्या । अगर्भया गर्भो भवति । पूजाकाले नमः, होमकाले स्वाहा, शान्तौ स्वधा,
अमुकं वश्यं कुरु कुरु वषट्, अमुकं आकर्षय आकर्षय सं वौषट्, अमुकं विद्विष्टं कुरु
कुरु हुं, अमुकं उच्चाटय उच्चाटय हुं फट्, अमुकं ज्वरेण गृह्ण गृह्ण घे घे ।

इति षट्कर्मकरं यन्त्रं पद्मावत्याः सर्वकाले पूजनीयम् ॥



परिशिष्ट ४

श्रीपद्मावतीव्रतोद्यापनम्



नमः श्रीपार्श्वनाथाय मोक्षलक्ष्मीनिवासिने ।
वक्ष्ये पद्मावतीपूजां चतुर्विंशतिअङ्गया(संख्यया) ॥१॥
मण्डलं कारयेत् सूरिश्चतुर्विंशतिकोष्ठकम् ।
पञ्चवर्णं महारम्यं रत्नप्रभासमन्वितम् ॥२॥
आदौ गन्धपुटीपूजा पश्चात् स्वगुरुपूजनम् ।
देवतापूजनं कुर्याद् धर्मकामार्थसाधनम् ॥३॥
कुर्वन् बुद्ध्या इमां पूजां तस्य विघ्नोपहारिणीम् ।
वाञ्छितार्थाऽखिलं दद्यात् पद्मिनी सुखदायिनी ॥४॥
ये लोकाः पूजयन्ति भगवति महति देवि पद्माङ्घ्रि भक्त्या
दंष्ट्रादाढाकराला जिनपदनिवशि उग्रतेजातिमानी (?) ।
तेषां सा पापहन्त्री निरुपमसुखदा पुत्रदारादिकल्पा-
दायी स्वर्गापवर्गा(न्) धरणिधरपतिदेवनाथादिसेव्या ॥५॥
ये पूजयन्ति मनकायमानी तेषां जनानां सुखदायकानि ।
पद्मावतीनाम परं पवित्रं सद्यः फलादान ददाति पूजा ॥६॥
इति प्रथमं निरुपमपुष्पाञ्जलिः ।

अथ श्रीपार्श्वनाथस्तवनम् ।

ह्रीं देवं पार्श्वनाथं धरणिपतिनुतं देवदेवेन्द्रवन्द्यं
ह्रींकारं बीजमन्त्रं जगदकलिमलं सर्वोपद्रव्यहारी ।
ॐ ह्रीं ह्रीं ह्रींकारनाद् अघहरति महाभक्तिरूपं जनानाम् ।
व्यालीढं पादपीठं कमठशठमर्ति माह्वयं पार्श्वनाथम् ॥१०॥

ॐ ह्रीं अर्हं श्रीपार्श्वनाथाय अत्रावतरावतर संवोषट् स्वाहा । आह्वाननम् ।

ॐ ह्रीं अर्हं श्रीपार्श्वनाथाय अत्र तिष्ठ तिष्ठ ठः ठः स्वाहा । स्थापनमन्त्रः ।

ॐ ह्रीं श्रीपार्श्वनाथाय अत्र मम सन्निहितो भव भव वषट् स्वाहा ।

सन्निधापनम् ।

अथाष्टकम् ।

ह्रीं ह्रींकारबीजं भूरिरूपतेजं गुणाधिकराज्यं सुराधिपपूज्यम् ।

क्षीराब्धिसुवारिभिः काश्मीरयुक्तैर्भवकल्मषहारैर्जिनमर्चयामि ॥

ॐ ह्रीं सकलमन्त्रबीजाय ह्रींकाराय विश्वविघ्नहरणाय जलम् ॥ १ ॥

हुं ह्रींकारनाम्नी परं स्फोटयापं जनानां सुखदायकं विघ्नहारम् ।

देवरण्यश्रीखण्डकुङ्कुमयुक्तैर्घुपुस्तापहारैर्जिनं पूजयामि ॥ गन्धम् ॥ २ ॥

ॐ ह्रीं देवमन्त्रं वामादेवीसुतं अखण्डं पदं निर्मितं पार्श्वनाथम् ।

क्षीराब्धिप्रफेनैः समं तण्डुलौघैरखण्डैरक्षतैर्गतहेमपात्रैः ॥

अक्षतम् ॥ ३ ॥

धूं हूं रक्ष रक्ष भैरवातिभीमां ह्रीं हूं हः वहननस्फुटबन्धबन्धम् ।

जपाजातिमोगरचम्पकपुष्पै रणद्गन्धलुब्धैर्भ्रमङ्गमरवृन्दैः ॥ पुष्पम् ॥ ४ ॥

वमं हंसवाद्यं सुधावीजमन्त्रं श्रुधावेदनिवारितं पार्श्वनाथम् ।

वटाखज्जकैर्मोदकैः शालिभक्तैः गतैर्हेमपात्रे बहूअन्नपाकैः ॥

नैवेद्यम् ॥ ५ ॥

क्ष्मां क्ष्मां बीजसारहरिद्देहवर्णं हरन्मोहध्वान्तं जिनाधिपपूज्यम् ।

ज्वलद्दीपघृतादिकर्पूरयुक्तैः शिखापिङ्गवर्णैर्यथावग्रनेत्रैः ॥

दीपम् ॥ ६ ॥

ध्रं ध्रं ध्रः प्रसूतं हतं शाकिनीनां महत्क्रूरकर्म दहनं दग्धरूपम् ।

लसद्दूधूपधूषैः कृष्णागुरुधूपैः सुगन्धीकृतार्द्धिजिनं पूजयामि ॥

धूपम् ॥ ७ ॥

स्फ्रीं स्फ्रीं वसनादं जगत्पूज्यवादं हतादुष्टदुःखं गताभीष्टरूपम् ।

फलैर्दाडिमैर्द्राक्षकैर्मातुलिङ्गैः जिनं पूजितं श्रीफलैर्भावयुक्तैः ॥

फलम् ॥ ८ ॥

आपैर्गन्धैरक्षतैः पुष्पश्चारुदीपधूपैः फलैर्घैः ।

काञ्चनपात्रैर्मङ्गलदानैर्दद्यादर्घ्यं श्रीजिननाथम् ॥

इत्थं मन्त्रं नित्यं ध्यायन् तस्मिन् सिद्धिं च प्रदेयम् ।

वामासुतं पद्मासेव्यं भक्तिभावमर्चितं च ॥

अथ स्तोत्रम् ।

श्रीमहेवेन्द्रवृन्दामलमणिमुकुटं ज्योतिषां चक्रवालै-

व्यालीढं पादपीठं शठकमठकृतोपद्रवाबाधितस्य ।

लोकालोकावभासी स्फुरदुदुखविमलज्ञानसद्दीपकं च

प्रध्वस्तध्वान्तजालः स वितरतु सुखं संस्तुवे पार्श्वनाथम् ॥ १ ॥

हां हीं हूं ह्रौं विभास्यन्मरकतमणिकारान्तमूर्ते ! ह्रिमं च

हं सं तं वीजमन्त्रैः कृतसकलजगत्क्षेमरक्षोरुवक्षः ।

क्षां क्षीं क्षां क्षां समस्तक्षितितलमहिता ज्योतिरुद्योतितार्थम्

क्षं क्षां क्षां क्षः क्षितवीजो गुरुशुभमरैः संस्तुवे पार्श्वनाथम् ॥ २ ॥

हींकारे रेफयुक्तं ररररररं देवसंसं प्रयुक्तं

ॐ हीं क्लीं क्लं(हांहीं) समेतं विषदमदकलाकचचकोद्भासि हुं हुं ।

धुं धुं धुं धूम्रवर्णैरखिलमहिजगन्मोहिदेह्यानुकृष्टं

वैषण्यं पतन्तं त्रिजगदधिपते ! संस्तुवे पार्श्वनाथम् ॥ ३ ॥

आं क्रां ह्रीं सर्वेश्वरं कुरु कुरु सरसं कामणं तिष्ठ तिष्ठ

क्षूं हूं हूं रक्ष रक्ष प्रबलतरमहाभैरवारातिभीमैः ।

हां हीं हूं द्रावयेति द्रव हन हन फट् फट् वषट् बन्ध बन्ध

स्वाहामन्त्रं पठन्तं त्रिजगदधिपते संस्तुवे पार्श्वनाथम् ॥ ४ ॥

हं सं इवीं क्षीं सहंसः कुवलयकलितैरचिताङ्गः प्रसूनै-

इवीं भः हः घर्क्षहंसं हरहरहहहं पक्षिपः पाक्षिकोपम् ।

पवं हंसः पवंसं सरसर सरसत् सत्सुधावीजमन्त्रैः

स्नायस्थाने परत्नैः प्रबलति त्रिमुखं संस्तुवे पार्श्वनाथम् ॥५॥

क्षमां क्षमां क्षमूं क्षमौं क्षः रेतै...हपति विनुतं रत्नदीपैः प्रदीपैः

हाहाकारोग्रनादैर्ज्वलद्दहनशिखाकल्पदीर्घोर्ध्वकेशैः ।

पिङ्गाक्षैर्ललिजिह्वैर्विषमविषधरालङ्कृतैस्तीक्ष्णदंष्ट्रै-

भूतैः प्रेतैः पिशाचैरनघकृतमहोपद्रवादक्षितारम् ॥६॥

झां झीं झः शाकिनीनां सपदि हरपदं त्रिविंशुद्वैविबुद्धैः

ग्लों क्षमं डं दिव्यजिह्वागतिमतिकुपितं स्तम्भनं संविधेहि ।

फट् फट् सर्पादिरोगं ग्रहमरणभयोच्चाटनं चैव पार्श्वं

त्रायस्वाशेषदोषादमरनरवरैः संस्तुवे पार्श्वनाथम् ॥७॥

स्फ्रां स्फ्रीं स्फ्रूं स्फ्रौं स्फ्रः प्रबलसुफलदं मन्त्रवीजं जिनेन्द्रम्

रां रौं रौं रूं रः प्रमह...महितं पार्श्वदेवाधिदेवम् ।

क्रां क्रीं क्रूं क्रीं क्रः जजजजजजरा जर्जरीकृत्य देहं
 धूं धूं धूं धूं धुं धुं धुं धुं ससमदुरितहं संस्तुवे पार्श्वनाथम् ॥ ८ ॥
 इत्थं मन्त्राक्षरोत्थं वचनमनुपमं पार्श्वनाथं सनित्यं
 विद्वेषोच्चाटनादिस्तभनजयवशं पापरोगापनोदि
 प्रोत्सर्पज्जङ्गमादिस्थविरविषमुखध्वंसनं स्वायुदीर्घै-
 रारोग्यैश्वर्ययुक्तो भवति यशःसुखं स्तौति तस्येष्टसिद्धिः ॥ ९ ॥

अथ जयमाला ।

वन्दे तं जिनपार्श्वनाथमनघं ! रत्नत्रयालङ्कृतं
 ह्रीं बीजं मतिदुःखदावशमनं घोरोपसर्गापहम् ।
 देवेन्द्राधिपतिं खगाधिपनतं वन्ध्यापिनारीसुतं
 पद्मिनीसतिशासनं भयहरं नागेन्द्रसेवान्वितम् ॥१॥
 अमरनाथगणाधिपवन्द्यं मुनिजनआर्यासेवितपादम् ।
 भक्तिनम्रभवसागरपोतं वाक्यामृतरसपोषितभूतम् ॥२॥
 कृतोपसर्गं कमठैर्गरिष्ठं जितवारातिभवान्तरश्रेष्ठम् ।
 कुण्डलकुण्डलिनीकृतछत्रं वारितमेघाडम्बरशस्त्रम् ॥३॥
 कर्मपर्वतहतासमवज्रं भयतमवारणसूर्यसुसज्जम् ।
 केवलज्ञानविलोकनदक्षं बोधितलोकालोकविपक्षम् ॥४॥
 राजितसमवसरणसुनिधानं चामरछत्रसिंहासनमानम् ।
 सुरासुरखेचरतिष्ठति सौख्यं द्वादशभासाहितसन्मुख्यम् ॥५॥
 धर्मप्रकाशितलक्षणसहितं मूलदयानिधिपापविरहितम् ।
 जन्तूत्तारणसमरथसूरं भव्यकमलवाक्यामृतपूरम् ॥६॥
 देवी पद्मावति वामे विशालं रक्षतु शासनमुखद्रुमजालम् ।
 दक्षिणदिशि सोहृद् फणिराजं विघ्ननिवारणदेवविराजम् ॥७॥
 ईदृग्विधि पार्श्वजिनं प्रणम्यं अनन्तचतुष्टयगम्यागम्यम् ।
 ये नरनारि त्रिकाल पूजन्ति ते मन वञ्चित सफल लहन्ति ॥८॥
 नाग नागिणी अतिशय धारी उधर्या दंपती जनसुखकारी ।
 क्रूरघोरघनदुःखनिधारी वञ्छितफल अतिदायक भारी ॥९॥

धत्ता (मालिनी !)

आपद्विविधहारी संपदासौख्यकारी

त्रिभुवनपदधारी सिद्धिलोकाग्रसूरी ।

जलबहुविधपूरैर्गन्धमाल्यादिसारै-

जिनवरमुखविम्बं पूजितं भावभक्त्या ॥९॥ ॐ ह्रीं क्रीं महार्घं ॥

अथ धरणेन्द्रपूजा ।

धरणयक्षविलक्षविसङ्गासे (?) क्षितिधरोन्न(त)कच्छपवाहने !
त्रिदशवन्दितपार्श्वजिनक्रमं प्रणतमौलिमणिं सदलं श्रिया ॥१॥

ॐ ह्रीं क्रीं धरणेन्द्राय अत्रावतरावतर सं वौषट् स्वाहा । आह्वाननम् ।

॥ अत्र तिष्ठ तिष्ठ ठः ठः स्थापनम् ।

॥ अत्र मम सन्निहितो भव भव वषट् सन्निधापनम् ।

अथाष्टकम् ।

अम्भोभृङ्गारस्वर्णाभा सौगन्धिभिर्मधुव्रतैः ।

फणीन्द्रं पूजितं भक्त्या सर्वविघ्नापहारिणम् ॥ ॐ ह्रीं क्रीं धरणेन्द्राय जलं० १

चन्दनैः कुसुमैः सारैर्भृङ्गार्द्रकृतगन्धिभिः ।

फणीन्द्रं पूजितं भक्त्या सर्वविघ्नापहारिणम् ॥ ” गन्धं० २

तन्दुलैः पाण्डुलाखण्डैः कुन्दगौरसमप्रभैः ।

फणीन्द्रं पूजितं भक्त्या सर्वविघ्नापहारिणम् ॥ ” अक्षतं० ३

मन्दाराचम्पकं जातिपुष्पवाहहताक्षमैः ।

फणीन्द्रं पूजितं भक्त्या सर्वविघ्नापहारिणम् ॥ ” पुष्पम् ॥४॥

मण्डकैर्मौदकैर्भक्तैर्हमभाजनसंस्थितैः ।

फणीन्द्रं पूजितं भक्त्या सर्वविघ्नापहारिणम् ॥ ” नेवेद्यम् ॥

कर्पूरनिर्धूमवर्तैस्तिमिराहतदीपकैः । फणीन्द्रं० सर्ववि० दीपम् ॥

पनसैः श्रीफलैर्द्रक्षैरभीष्टफलदायकैः । ” ” फलम् ॥

कृष्णागुरुधूपधूमैर्घातिकर्मसुदाहकैः । ” ” धूपम् ॥

जलं गङ्गाक्षतैरर्घैर्धरणेन्द्रार्चितं मुदा । ” ” अर्घ्यम् ॥

श्रीपार्श्वनाथपदपङ्कजसेव्यमानं पद्मावती भजति वाङ्मनवामभागम् ।

घोरोपसर्गहननं निजमानदक्षं तं देवशुद्धमतिगं प्रभजामि नित्यम् ॥

ॐ पुष्पाञ्जलि० ॥



परिशिष्ट. ५

श्रीपद्मावतीस्तोत्रम् ।

श्रीमद्रीर्वाणचक्रस्फुटमुकुटतटीदिव्यमाणिक्यमाला-
ज्योतिर्ज्वालाकरालास्फुरितमुकुरिकाघृष्टपादारविन्दे !
व्याघोरोल्कासहस्रस्फुरज्ज्वलनशिखालोलपाशाङ्कुशाढ्ये
ॐ ओं क्रीं ह्रीं मन्त्ररूपे ! क्षपितकलिमले ! रक्ष मां देवि ! पद्मे ॥१॥

भित्त्वा पातालमूलं चलचलचलिते ! व्याललीलाकरालै-
विंशुहण्डप्रचण्डप्रहरणसहितैस्तद्भुजैस्तर्जयन्ती ।
दैत्येन्द्रक्रूरदंष्ट्राकटकटघटिते ! स्पष्टभीमाट्टहासे !
मायाजीमूतमालाकुहरितगगने ! रक्ष मां देवि ! पद्मे ! ॥२॥

कूजत्कोदण्डकाण्डोडुमरविधुरिते ! क्रूरघोरोपसर्गं
दिव्यं वज्रातपत्रं प्रगुणमणिरणत्किङ्किणीक्वाणरम्यम् ।
भास्वद्वैडूर्यदण्डं मदनविजयिनो बिभ्रती पार्श्वभर्तुः
सा देवी पद्महस्ता विघटयतु महाडामरं मामकीनम् ॥३॥

भृङ्गी काली कराली परिजनसहिते ! चण्डि चामुण्डि नित्ये !
क्षा क्षीं क्षूं क्षः क्षणार्धे क्षतरिपुनिवहे ! ह्रीं महामन्त्ररूपे ! ।
ध्रां ध्रीं धूं धृः धृङ्गसङ्गधुकुटिपुटतटत्रासितोद्दामदैत्ये !
इर्षां इर्वीं इर्वूं इवः प्रचण्डे ! स्तुतिशतमुखरे ! रक्ष मां देवि ! पद्मे ! ॥४॥

चञ्चत्काञ्चीकलापे ! स्तनतटविलुठत्तारहारावलीके !
प्रोत्फुल्लत्पारिजातद्रुमकुसुममहामञ्जरीपूज्यपादे ! ।
ह्रीं ह्रीं ह्रीं ह्रूं समेते भुवनवशकरे ! क्षोभिणी द्राविणी त्वं
आं ईं ऊं पद्महस्ते ! कुरु कुरु घटने रक्ष मां देवि ! पद्मे ! ॥५॥

लीलाव्यालोलनीलोत्पलदलनयने ! प्रज्वलद्वाडवाग्नि-

प्रोद्यज्ज्वालास्फुलिङ्गस्फुरदरुणकरोदग्रवज्राग्रहस्ते ! ।

ह्राँ ह्रीँ ह्रूं ह्रः हरन्ती हरहरहरहुंकारभीमैकनादे !

पद्मे ! पद्मासनस्थे व्यपनय दुरितं देवि ! देवेन्द्रवन्द्ये ! ॥६॥

कोपं वं झं सहंसः कुवलयकलितोद्दामलीलाप्रबन्धे !

ज्रां ज्रीं ज्रूं ज्रः पवित्रे शशिकरधवले प्रक्षरत्क्षीरगौरे ! ।

व्यालव्यावद्भ्रजूटे प्रबलबलमहाकालकूटं हरन्ती

हा हा हुंकारनादे ! कृतकरकमले ! रक्ष मां देवि ! पद्मे ! ॥७॥

प्रातर्बालार्करश्मिच्छुरितघनमहासान्द्रसिन्दूरधूली-

सन्ध्यारागारुणाङ्गि त्रिदशवरवधूवन्द्यपादारविन्दे ! ।

चञ्चच्चन्द्रासिधाराप्रहतरिपुकुले कुण्डलोद्धृष्टगह्वरे !

श्रां श्रीं श्रूं श्रः स्मरन्ती मदगजगमने ! रक्ष मां देवि ! पद्मे ! ॥७॥

विस्तीर्णे पद्मपीठे कमलदलनिवासोचिते कामगुप्ते

लांतांगीश्रीसमेते प्रहसितवदने दिव्यहस्ते ! प्रसन्ने ! ।

रक्ते रक्तोत्पलाङ्गि प्रतिवहसि सदा वाग्भवं कामराजं

हंसारूढे ! त्रिनेत्रे ! भगवति ! वरदे ! रक्ष मां देवि ! पद्मे ! ॥९॥

पट्कोष्णे चक्रमध्ये प्रणतवरयुते वाग्भवे कामराजे

हंसारूढे सबिन्दौ विकसितकमले कर्णिकाग्रे निधाय ।

नित्ये क्लिप्ते मदद्रैर्द्रव इति सहितं साङ्कुशे पाशहस्ते !

ध्यानात् संशोभकारिन्निभुवनवशकृद् रक्ष मां देवि ! पद्मे ! ॥१०॥

आं क्रौं ह्रीं पञ्चवाणैर्लिखितपट्दले चक्रमध्ये सहंसः

ह्रस्क्लौं श्रीं पत्रान्तराले स्वरपरिकलिते वायुना वेष्टिताङ्गी ।

ह्रीं त्रेष्टे रक्तपुष्पैर्जपति मणिमतां क्षोभिणी वीक्ष्यमाणा

चन्द्रार्कं चालयन्ती सपदि जनहिते रक्ष मां देवि ! पद्मे ! ॥११॥

गर्जन्नीरदगर्भनिर्गततडिज्ज्वालासहस्रस्फुरत्-

सद्वज्राङ्कुशपाशपङ्कजधरा भक्त्यामरैरर्चिता ।

सद्यः पुष्पितपारिजातरुचिरं दिव्यं वपुर्बिभ्रती

सा मां पातु सदा प्रसन्नवदना पद्मावती देवता ॥१२॥

जिह्वाग्रे नासिकान्ते हृदि मनसि दृशोः कर्णयोर्नाभिपद्मे

स्कन्धे कण्ठे ललाटे शिरसि च भुजयोः पृष्ठिपार्श्वप्रदेशे ।

सर्वाङ्गोपाङ्गशुद्ध्यान्यतिशयभवनं दिव्यरूपं स्वरूपं

ध्यायामः सर्वकालं प्रणयलयगतं पार्श्वनाथेतिशब्दम् ॥१३॥

ब्रह्माणी कालरात्री भगवति वरदे ! चण्डि चामुण्डि नित्ये
 मातङ्गी गौरिधारी धृतिमतिविजये कीर्तिर्हीस्तुत्यपन्ने ! ।
 संग्रामे शत्रुमध्ये जलज्वलनजले वेष्टिते तैः स्वरास्त्रैः
 क्षां क्षीं क्षूं क्षः क्षणार्धे क्षतरिपुनिवहे ! रक्ष मां देवि ! पद्मे ! ॥१४॥
 भूविश्वेक्षणचन्द्रचन्द्रपृथिवीयुग्मैकसंख्याक्रमा-
 चन्द्राम्भोनिधिवानषण्मुखवशं दिक्खेचराशादिषु ।
 वेश्वर्यं रिपुमारविश्वभयकृत् क्षोभान्तराया विपाः
 लक्ष्मीलक्षणभारतीगुरुमुखान्मन्त्रानिमा देवते ! ॥१५॥
 खड्गैः कोदण्डकाण्डैर्मुशलहलकिणैर्वज्रनाराचचक्रैः
 शक्त्या शल्यैस्त्रिशूलैर्वरशफरैर्मुद्गरैर्मुष्टिदण्डैः ।
 पाशैः पाषाणवक्षैर्वरगिरिसहितैर्दिव्यशस्त्रैरमानै-
 दुष्टान् संहारयन्ती वरभुजललिते ! रक्ष मां देवि ! पद्मे ! ॥१६॥
 यस्या देवर्नरेन्द्रैरमरपतिगणैः किन्नरैर्दानवेन्द्रैः
 सिद्धैर्नागेन्द्रयक्षैर्नरमुकुटतटैर्घृष्टपादारविन्दैः ।
 सौम्ये सौभाग्यलक्ष्मीदलितकलिमले ! पद्मकल्याणमाले !
 अम्बे ! काले समाधिं प्रकटय परमं रक्ष मां देवि ! पद्मे ! ॥१७॥
 धूपैश्चन्दनतण्डुलैः शुभमहागन्धैः समन्त्रालिकै-
 र्नानावर्णफलैर्विचित्रसरसैर्दिव्यैर्मनोहारिभिः ।
 पुष्पैर्नैवेद्यवस्त्रर्मनभुवनकरा भक्तियुक्तैः प्रदाता
 राज्ये हेत्वं गृहाणे भगवति वरदे ! रक्ष मां देवि ! पद्मे ! ॥१८॥
 क्षुद्रोपद्रवरोगशोकहरणी दारिद्र्यविद्रावणी
 व्यालव्याघ्रहरा फणत्रयधरा देहप्रभाभास्वरा ।
 पातालाधिपतिप्रिया प्रणयिनी चिन्तामणिः प्राणिनां
 श्रीमत्पार्श्वजिनेशशासनसुरी पद्मावती देवता ॥१९॥
 तारा त्वं सुगतागमे भगवती गौरीति शैवागमे
 वज्रा कौलिकशासने जिनमते पद्मावती विश्रुता ।
 गायत्री श्रुतशालिनां प्रकृतिरित्युक्तासि साङ्ख्यागमे
 मातभारति ! किं प्रभूतभणितैर्व्याप्तं समस्तं त्वया ॥२०॥
 पाताले कृशता विषं विषधरा घूर्मन्ति ब्रह्माण्डजाः
 स्वर्भूमिपतिदेवदानवगणाः सूर्येन्दवो यद्गुणाः ।
 कल्पेन्द्राः स्तुतिपादपङ्कजनता मुक्तामणिं चुम्बिता
 सा त्रैलोक्यनता मता त्रिभुवने स्तुत्या स्तुता सर्वदा ॥२१॥

सञ्जता कणवीररक्तकुसुमैः पुष्पैः समं सञ्चितैः
 सन्मिश्रैर्घृतगुग्गुलौघमधुभिः कुण्डे त्रिकोणे कृते ।
 होमार्थं कृतपोडशाङ्गुलशता वह्नौ दशांशैर्जपेत्
 तं वाचं वचसीह देवि ! सहसा पद्मावती देवता ॥२२॥
 ह्रींकारैश्चन्द्रमध्ये पुनरपि वलयं षोडशावर्णपूर्णं-
 वाहा कण्ठैरेवेष्ट्यं कमलदलयुतं मूलमन्त्रप्रयुक्तम् ।
 साक्षात् त्रैलोक्यवश्यं पुरुषवशकृतं मन्त्रराजेन्द्रराजं
 ...पतस्वरूपं परमपदमिदं पातु मां पार्श्वनाथः ॥२३॥
 प्रोत्फुल्लकुन्दनादे कमलकुचलये मालतीमाल्यपूज्ये
 पादस्थे भूधराणां कृतरणक्वणिते रम्यहंकाररावे ।
 गुञ्जत्काञ्चीकलापे पृथुलकटितटे तुच्छमध्यप्रदेशे
 हा हा हुंकारनादे ! कृतकरकमले ! रक्ष मां देवि ! पद्मे ! ॥२४॥
 दिव्ये पद्मे सुलग्ने स्तनतटमुपरि स्फारहारावलीके
 केयूरैः कङ्कणाद्यैर्वहुविधरचितैर्बाहुदण्डप्रचण्डैः ।
 भाभाले वृद्धतेजःस्फुरन्मणिशतैः कुण्डलोद्घृष्टगण्डे
 स्नां स्त्रीं स्त्रूं स्त्रः स्मरन्ती गजपतिगमने ! रक्ष मां देवि ! पद्मे ! ॥२५॥
 या मन्त्रागमवृद्धिमानचितनोल्लासप्रसादार्पणां
 या इष्टाशयकल्सकर्मणगणप्रध्वंसदक्षाङ्गुशा ।
 आयुर्वृद्धिकरां ज्वरामयहरां सर्वार्थसिद्धिप्रदां
 सद्यः प्रत्ययकारिणीं भगवतीं पद्मावतीं संस्तुवे ॥२६॥
 पद्मासना पद्मदलायताक्षी पद्मानना पद्मकराङ्घ्रिपद्मा ।
 पद्मप्रभा पार्श्वजिनेन्द्रशक्ता पद्मावती पातु फणीन्द्रपत्नी ॥२७॥
 मातः ! पद्मिनि ! पद्मरागरुचिरे ! पद्मप्रसूनानने !
 पद्मे ! पद्मवनस्थिते ! परिलसत्पद्माक्षि ! पद्मानने ! ।
 पद्मामोदिनि ! पद्मकान्तिवरदे ! पद्मप्रसूनार्चिते !
 पद्मोल्लासिनि ! पद्मनाभिनिलये ! पद्मावती पाहि माम् ॥२८॥
 या देवी त्रिपुरा पुरत्रयगता शीघ्रासि शीघ्रप्रदा
 या देवी समया समस्तभुवने सङ्गीयते कामदा ।
 तारा मानविमर्दिनी भगवती देवी च पद्मावती
 तास्ताः सर्वगतास्तमेव नियतं मायेति तुभ्यं नमः ॥२९॥
 त्रुट्यत्शङ्कलबन्धनं बभ्रुविधैः पाशैश्च यन्मोचनं

स्तम्भे शत्रुजलाग्निदारुणमहीनागारिनाशे भयम् ।
 दारिद्र्याग्रहरोगशोकशमनं सौभाग्यलक्ष्मीप्रदं
 ये भक्त्या भुवि संस्मरन्ति मनुजास्ते देवि ! नामग्रहम् ॥३०॥
 भक्तानां देहि सिद्धिं मम सकलमघं देवि ! दूरीकुरु त्वं
 सर्वेषां धार्मिकाणां सततनियततं वाञ्छितं पूरयस्व ।
 ससाराब्धौ निमग्नं प्रगुणगणयुतं जीवराशिं च त्राहि
 श्रीमज्जैनेन्द्रधर्मं प्रकटय विमलं देवि ! पद्मावति ! त्वम् ॥३१॥
 दिव्यं स्तोत्रं पवित्रं पटुतरपठतां भक्तिपूर्वं त्रिसन्ध्यं
 लक्ष्मीसौभाग्यरूपं दलितकलिमलं मङ्गलं मङ्गलानाम् ।
 पूज्य कल्याणमाद्यं जनयति सततं पार्श्वनाथप्रसादाद्
 देवी पद्मावती नः प्रहसितवदना या स्तुता दानवेन्द्रैः ॥३२॥
 पठितं भणितं गुणितं जयविजयरमानिबन्धनं परमम् ।
 सर्वाधिव्याधिहरं जपतां पद्मावती स्तोत्रम् ॥३३॥
 आद्यं चोपद्रवं हन्ति द्वितीयं भूतनाशनम् ।
 तृतीये चामरीं हन्ति चतुर्थे रिपुनाशनम् ॥३४॥
 पञ्च पञ्चजनानां च वशीकारं भवेद् ध्रुवम् ।
 षष्ठे चोच्चाटनं हन्ति सप्तमे रिपुनाशनम् ॥३५॥
 अत्योद्वेगा चाष्टमे च नवमे सर्वकार्यकृत् ।
 दृष्टा भवन्ति तेषां च त्रिकालपठनार्थिनाम् ॥३६॥
 आह्वानं नैव जानामि न जानामि विसर्जनम् ।
 पूजार्चं नैव जानामि त्वं गतिः परमेश्वरि ! ॥३७॥

अथाह्वाननम् ।

श्रीपार्श्वनाथ ! जिननायक ! रत्नचूडा-
 पाशाङ्कुशोरगफलाङ्कितदोश्चतुष्का ।
 पद्मावती त्रिनयना त्रिफणावतंसं
 पद्मावती जयति शासनपुण्यलक्ष्मीः ॥

ॐ आँ क्रौं अरुणवर्णसर्वलक्षणसम्पूर्णः स्वायुधवाहनबन्धुचिह्नसपरिवारान् नमो-
 ऽस्तुते हे पद्मावति ! देवि ! अत्रागच्छागच्छ तिष्ठ तिष्ठ ठः ठः मम सन्निहिता भव
 भव घषट् स्वाहा ।

अथाष्टकम्

ॐ ह्रीं श्रीं मन्त्ररूपे ! विबुधजननुते ! देवदेवेन्द्रवन्द्ये !
 चञ्चन्द्रावदाते ! क्षपितकलिमले ! हारनीहारगौरे ! ।
 भीमे ! भीमाट्टहासे भवभयहरणे ! भैरवे ! भीमरूपे
 ह्रीं ह्रीं ह्रूंकारनादे ! विशद्जलभरैस्त्वां यजे देवि ! पद्मे ! ॥१॥
 ॐ ह्रीं श्रीं श्रीं पद्मावत्यै जलं० १
 हा पक्षी(क्षि)बीजगर्भे सुरवररमणीचर्चितेऽनेकरूपे !
 कोपं वं झं विधेयं धरिततवधरे योगिनी योगमार्गे ।
 हं हंसः स्वर्गजैश्च प्रतिदिननमिते ! प्रस्तुतापापपट्टे
 दैत्येन्द्रैर्ध्यायमाने ! विमलसलिलजैस्त्वां यजे देवि ! पद्मे ! ॥२॥

गन्धं० २

दैत्यैर्दैत्यारिनाथैर्नमितपद्मयुगे ! भक्तिपूर्वं त्रिसन्ध्यं
 यक्षैः सिद्धैश्च नम्रैरहमहमिकया देहकान्त्याश्च कान्त्यै ।
 आं इं उं तं अ आ आ गृढ गृढ मृडने सः स्वरे न्यस्वरे नैः
 तेवप्राहीयमाने क्षतधवलभरैस्त्वां यजे देवि ! पद्मे ! ॥३॥

अक्षतम् ।

क्षां क्षीं थूं क्षः स्वरूपे ! हन विषमविषं स्थावरं जङ्गमं वा
 संसारे संसृतानां तव चरणयुगे सर्वकालान्तराले ।
 अव्यक्तव्यक्तरूपे ! प्रणतनखरे ! ब्रह्मरूपे ! स्वरूपे !
 पंक्तियोगीन्द्रगम्ये सुरभिःशुभक्रमे ! त्वां यजे देवि ! पद्मे ! ॥४॥

पुष्पम् ॥

पूर्णं विज्ञानशोभाशशधरधवले दास्यविम्बं प्रसन्नै
 रम्ये स्वच्छे स्वकान्त्यै द्विजकरनिकरे चन्द्रिकाकारभासे ।
 आस्मिन्किन्नाभवर्ज्यां दिनमनुसततं कल्मषं क्षालयन्ती
 भ्रां श्रीं श्रूं मन्त्ररूपे ! विमलचरुवरैस्त्वां यजे देवि ! पद्मे ! ॥५॥
 नैवेद्यम् !

भास्वत्पद्मासनस्थे ! जिनपदनिरते ! पद्महस्ते ! प्रशस्ते !
 प्रां प्रीं प्रूं प्रः पवित्रे ! हर हर दुरितं दुष्टजं दुष्टचेष्टे ! ।
 वाचाला भावभक्त्या त्रिदशयुवतिभिः प्रत्यहं पूज्यपादे !
 चन्द्रे चन्द्रीकराले मुनिगृहमणिभिस्त्वां यजे देवि पद्मे ! ॥६॥

दीपम् ॥

नम्रीभूतक्षितीशप्रवरमणितटोद्घृष्टपादारविन्दे !
 पद्माक्षे ! पद्मनेत्रे ! गजपतिगमने ! हंसशुभ्रे विमाने ।
 कीर्तिश्रीवृद्धिचक्रे ! शुभजयविजये ! गौरिगान्धारियुक्ते !
 देप देप शरण्ये गुरुसुरभिभरैस्त्वां यजे देवि ! पद्मे ! ॥७॥

धूपम् ॥

विद्युज्ज्वालाप्रदीप्ते प्रवरमणिमयामक्षमालां कराले
 रम्ये वृत्तां धरन्ती दिनमनुसततं मंककं सारदं च ।
 नागेन्द्रैरिन्द्रचन्द्रैर्दिविपमनुजनैः संस्तुता देवदेवि !
 पद्मर्चे ! त्वां फलौघैर्दिशतु मम सदा निर्मलशर्मसिद्धिः ॥८॥

फलम् ॥

श्रीमन्महाचीनदुकूलनेत्रे सत्क्षौमकौशेयकचीनवस्त्रैः ।
 शुभ्रांशुके श्यनमनिप्रभांगी(?) यजामहे पन्नगराजदेवि ! ॥९॥

शुभ्रवस्त्रम् ।

काञ्चीसूत्रविनूतरसनिचितैः केयूरसत्कुण्डलै-
 मञ्जीराङ्गदमुद्रिकादिमुकुटप्रालम्बिकावासकैः ।
 अञ्जुचाटिकादिद्विलगद्ग्रैवेयकैर्भूषणैः
 सिन्दूराङ्गसुकान्तिवर्षसुभगैः सम्पूजयामो वयम् ॥१०॥

षोडशाभरणम् ॥

वारिभिर्गन्धैरक्षतपुष्पैश्चरुवरदीपैर्धूपफलार्घैः ।
 क्रीं ह्रीं श्रीं क्षां सुवीजपूरमन्त्रे इवीं प्रां धं हुं हुं यन्त्रशुभमर्चे ॥११॥
 अर्घम् ॥

अम्भोभिर्दिव्यगन्धैरलिकुलकलितैर्गन्धशाल्यक्षतौघैः
 कुन्दाद्यैर्दिव्यवद्भिरतुलशुचिवरैर्दीपकैः काम्यधूपैः ।
 सुस्वादैनैर्नालिकेरैर्विलसितविमलैर्षप्रचक्रैरणार्घैः
 कल्याणानाङ्गभाजां विमलगुणवती पूजयामीष्टसिद्धयै ॥१२॥

पूर्णार्घम् ॥

अथ प्रत्येकपूजा ।

श्रीसव्यपाणिगततीक्ष्णमखं वज्रायुधं नाम जगत्प्रसिद्धम् ।
 त्रैलोक्यव्याप्तं भयनाशनं च पद्मावति ! त्वत्पदमर्चयामि ॥१॥
 ॐ श्रीं क्रीं ह्रीं सव्यहस्तवज्रधारणे जलं १
 भित्त्वा सुपातालमूलं च शस्त्रं कृत्वा विनाशं कलिघोरदुःखम् ।
 सुवामभागे करमङ्कुशं च अर्चामि शस्त्रं जनशर्मकारि ॥२॥

कमलकरसुसंस्थं भीमरूपं च देवीं
अखिलमघनिवारं सव्यभोगा च नाम्नी ।

जिनचरणसुसेव्यं पद्मिनीनामसारं
खचरभुचरवन्द्यं वारिगन्धादिपूज्यम् ॥३॥
ॐ आँ क्रौं ह्रीं तृतीयसव्यकरकमलधारिणे जलं० ॥

परमतमदहारिन् ! चक्रवामाङ्गधारिन् !
भवश्रमखलुवारि भूतप्रेतादिहारि ।
निखिलभुवनचार्लि भव्यजीवकृपार्लि ।
धरणिधरसुपत्नीं पद्मिनीं पूजयामि ॥४॥

ॐ आँ क्रौं ह्रीं तुर्यवामकरचक्रबलिने जलं० ४ ॥

रिपुगणहतिदक्षं दैत्यदेवेन्द्रपक्षं महितलघनसाक्षं मुनिध्यानादिदक्षम् ।
स्वबलदक्षिणपाणिच्छत्रदैत्यारिहारिं समकितगुणखानिं पूजितं पद्मिनाम्नी ॥
ॐ आँ क्रौं ह्रीं पञ्चमदक्षिणकरच्छत्ररक्षिते जलं० ॥५॥

डमरुककरधारिं गर्जितं लोकनाहं अरिकुलमुलछेदी स्वर्गपातालमेदी ।
भवजनितवदुःखं मेदितं वर्तुलाग्रं सुखकरडमरुकं चर्चितं पद्मदेवि ! ॥
ॐ आँ क्रौं ह्रीं डमरुपद्योत्तरधारिणि जलं० ॥६॥

कपालपाणिविद्विलक्षणवामभागं देवेन्द्रपूजित सह सह व्यन्तरीभिः ।
श्रीपार्श्वनाथपदपङ्कजसेवमानां तं पूजयामि मनिभीप्सितमष्टसिद्धयै ॥७॥
ॐ आँ क्रौं ह्रीं कपालपाणीगृहीते जलं० ॥७॥

पद्मावत्यायुधपरिकरः तेजःपुञ्जं रसालकालभयत्रासनसव्यपाणी ।
पिङ्गोग्रतेजबलबालदिवाकरेऽस्मिस्तमायुधं गणितमष्टम् पूजयामि ॥८॥
ॐ आँ क्रौं ह्रीं नवमवामकरखङ्गधारिणे जलं० ॥८॥

रक्तप्रभा रक्तमुनेत्रधारि धनुषवामा प्रतापकारी ।
टङ्कारनादं वलिताचलं वा कोदण्ड पद्मावति पूजयामि ॥९॥
ॐ आँ क्रौं ह्रीं पुङ्गुसर्पिते जलं० ॥९॥

मूशलमायुधचिह्नकरस्थितं धृतसुरागसुमुष्टिद्वान्वितम् ।
विघनवारणदैत्यगणाधिपं भजतु पार्श्वजिनाङ्घ्रिजलादिकम् ॥१०॥
ॐ आँ क्रौं ह्रीं मूशलभयत्रासिने जलं० ॥१०॥

लाङ्गूलशस्त्रभयङ्करसर्पगं भजतु पाणिसुसव्यविराजितम् ।
सकलप्राणिदयापरयोजितं पूजितपादसुपद्मिनि देवताम् ॥११॥

ॐ आँ क्रौं ह्रीं सव्यहस्तहलधारिणे जलं० ॥११॥

वह्निकुमारं वामकरसंस्थं ज्वलिततेजः कलुषविदग्धम् ।
निर्धूमपावकशिखापवित्रं तं पदमर्चितमष्टसुद्रव्यैः ॥१२॥

ॐ आँ क्रौं ह्रीं वामपावकज्वालने जलं० ॥१२॥

दक्षिणदेशे धृतलम्बमाला त्रासितशत्रु तुपलप्रयुक्तम् ।
व्यन्तरभूतपिशाचविबद्धां स्रग्वलयाङ्कितपूजितपादम् ॥१३॥

ॐ आँ क्रौं ह्रीं दक्षिणदोर्भिण्डमालाचालिने जलं० ॥१३॥

तारामण्डलमाकयं निजकरे वामाङ्गमायुधकं
तारास्थं गगने विचुम्बितपरं वश्यं कृतं कल्पजम् ।

यद्येवं वहनं यथागतवरं तथा च कामार्थगं

तां देवीं मम पूजयामि सलिलैः रक्षेति रक्षं मम ॥१४॥

ॐ आँ क्रौं ह्रीं वामकरतारामण्डलभूषिते जलं० ॥१४॥

त्रिशूलतीक्ष्णवरदक्षिणपाणिराजं त्रिलोकसङ्कटविदारणदेवमानम् ।
भस्माङ्गभूतिपरिलेपनपद्मरङ्गं तमर्चयामि विधिपूर्वकसौख्यकारी ॥१५॥

ॐ आँ क्रौं ह्रीं सव्यहस्तत्रिशूलघातिने जलं० ॥१५॥

फरसशस्त्रमहामतिकोमलं अरिजष्टदशविमुनिभेदकम् ।
परशुवामकरं वरचन्द्रिकां यजतु देवगणं वरपद्मकाम् ॥१६॥

ॐ आँ क्रौं ह्रीं वामकरसारिभेदिने जलं० ॥१६॥

विषधरैः खलु सेवितदक्षिणे प्रबललक्ष्मिकृतारिपुनाशिने ।
उरगकेतुमहाभयनाशिने परमखेचरकिन्नरपूजिते ! ॥१७॥

ॐ आँ क्रौं ह्रीं दक्षिणफणिधारिणे जलं० ॥१७॥

मुद्गरनाशनरिपुजनघोरं वामकरे स्थितसबलसुसूरम् ।
भक्तिजनाः सुख ददतु प्रचुरं पूज्यरचनचरद्रव्यसुपूरम् ॥१८॥

ॐ आँ क्रौं ह्रीं वामरमुद्गररक्षिणे जलं० ॥१८॥

दण्डान्वितं दण्डखलस्य मूर्ध्नि संव्यासपाणी दृढमुष्टिधारी ।
शक्त्यायुधं दण्डसुमिश्रकान्ति जलादिपूजाविधिना च भक्त्या ॥१९॥

ॐ आँ क्रौं ह्रीं सव्यहस्तदण्डधारिणे जलं० ॥१९॥

सन्नागपाशधरशोभितवामहस्ते शत्रून् विबद्धफणिपाशसमग्रलोके ।
पद्मावतीद्विदशयुग्मकराङ्किते सात् तं पूजयामि भवतारक पुत्रदायिन् ! ॥२०॥

ॐ आँ क्रौं ह्रीं वामकरफणिपाशप्रसारिणे जलं० ॥२०॥

उपलनामपरिभूधरसदृशानां दक्षिणहस्तधृतमास्थलवर्तुलाग्रम् ।
 हंसारूढं गमनकुर्कटसर्पग्राहिं पाषाणयुद्धभयभञ्जनमन्त्रशस्त्रम् ॥२१॥
 ॐ आँ क्रौं ह्रीं दक्षिणहस्तपाषाणयुद्धधारिणे जलं० ॥२१॥
 वृक्षप्रचण्डकरसंस्थितवामभागे जम्बूद्वीपावसमकल्पितजम्बुवृक्षम् ।
 शत्रून् विदारणसमस्तदिगन्तरालं पद्मावतीधरणसंस्थित पूजयामि ॥२२॥
 ॐ आँ क्रौं ह्रीं वामकरधृतप्रचण्डवृक्षाय जलं० ॥२२॥
 खड्गं कोदण्डकाण्डौ मुशलहलफणिवहिनाराचचक्रं
 शक्त्या शाल्यात् त्रिशूलं खपरडमरुकं नागपाशं च दण्डम् ।
 पाषाणं मुद्गरं च फरसकमलसुअङ्कुशं चाभ्रछत्रं
 वज्रं वृक्षं चायुधं दुरितदुरिहरं पूजनं स्वेष्यसिद्धयै ॥२३॥
 पूर्णार्घ्यम् ॥

अथ जापः कथ्यते—

ॐ हौं ह्रीं हूं ह्रें ह्रैं ह्रौं ह्रौं ह्रः दातारस्य मम शान्तिं कुरु कुरु पद्मावत्यै नमः
 स्वाहा । वार १०८ तथा १२०००

अथ जयमाला ।

पद्माकारदलं विशुद्धनयनं सत्तेजसा भास्करं
 ह्रींवीजं जिनशासनीं भगवतीं भूजाचतुर्विंशतिः ।
 त्रैलोक्यं भुवि चालयन्ति वपुषा दैत्यं निहन्त्यं सदा
 हे देवि ! मम दुःखनाशनपरा तुभ्यं नमः स्तान् मुदा ॥१॥
 श्रीपार्श्वनाथवरसेवितचरणं पद्मावतीजनभवभयहरणम् ।
 फणिपतिरक्षणदक्षिणसहितं भवजलतारण परभयरहितम् ॥२॥
 वामभागविष्ट्रगणरक्षं दैत्यदानवभयनाशनदक्षम् ।
 हंसारूढकुर्कटपाणिवाहं गमनं दुर्धर जनत्रयमोहम् ॥३॥
 चतुर्विंशतिबाहुविराजं तेषामायुधविविधसुप्राजम् ।
 दक्षिणकर वज्रायुधसोहे वाम भाग अंकुश मन मोहे ॥४॥
 कमलचक्रछत्रांकितसारं डमरुकशोभा वामकरतारम् ।
 चाभ्रकपालखड्गधनुषकांसं बाणमुशलहलअरिशिरत्रासम् ॥५॥
 शक्तिवह्निज्वालागणधरणं भिण्डमालावरशत्रुकशरणम् ।
 तारामण्डलगगनविशालं दक्षिणकरशोभितत्रिशूलम् ॥६॥
 फरसनागमुद्गरप्रचण्डं सव्यहस्तधृतवर्तनदण्डम् ।

नागपाशपाषाणविशालं अंह्रिपसणकल्पद्रुमजालम् ॥७॥
 एवं आयुधग्रहणगरिष्ठं दुर्जनजंबलनाशनदुष्टम् ।
 कामिजनामनफलमभीष्टं पूजित पद्मावति देवी इष्टम् ॥८॥
 षोडशाभरणालङ्कृतगात्रं कमलाकरवरशोभितनेत्रम् ।
 चन्द्राननमुखममृततेजः रक्ताम्बरसुदयारसभाजम् ॥९॥
 पद्मावती देवी चरणपवित्रं अष्टविधार्चनहेमसुपात्रम् ।
 भावसहित पूजित नर नारी तेषां धणकणसंपत्ति भारी ॥१०॥

घत्ता—

विविधदुःखविनाशी दुष्टदारिद्र्यपाशी
 कलिमलभवक्षाली भव्यजीवकृपाली ।
 असुरमदनिवारी देवनागेन्द्रनारी
 जिनमुनिपदसेव्यं ब्रह्मपुण्याब्धिपूज्यम् ॥११॥

ॐ आँ क्रीं ह्रीं मन्त्ररूपायै विश्वविघ्नहरणायै सकलजनहितकारिकायै श्री पद्मावत्यै
 जयमालार्थं निर्वपामीति स्वाहा ।

लक्ष्मीसौभाग्यकरा जगत्सुखकरा बन्ध्यापि पुत्रार्पिता
 नानारोगविनाशिनी अघहरा(त्रि)कृपाजने रक्षिका ।
 रङ्गानां धनदायिका सुफलदा वाञ्छार्थिचिन्तामणिः
 त्रैलोक्याधिपतिर्भवार्णवत्राता पद्मावती पातु वः ॥१२॥

इत्याशीर्वादः

स्वस्तिकल्याणभद्रस्तु क्षेमकल्याणमस्तु वः ।
 यावच्चन्द्रदिवानाथौ तावत् पद्मावतीपूजा ॥१३॥
 ये जनाः पूजन्ति पूजां पद्मावती जिनान्विता ।
 ते जनाः सुखमायान्ति यावन्मेरुर्जिनालयः ॥१४॥

ॐ नमो भगवति ! त्रिभुवनवशंकरी सर्वाभरणभूषिते पद्मनयने ! पद्मिनी पद्मप्रभे !
 पद्मकोशिनि ! पद्मवासिनि ! पद्महस्ते ! ह्रीं ह्रीं कुरु कुरु मम हृदयकार्यं कुरु कुरु, मम
 सर्वशान्तिं कुरु कुरु, मम सर्वराज्यवश्यं कुरु कुरु, सर्वलोकवश्यं कुरु कुरु, मम सर्व-
 स्त्रीवश्यं कुरु कुरु, मम सर्वभूतपिशाचप्रेतरोषं हर हर, सर्वरोगान् छिन्द छिन्द, सर्व-
 विघ्नान् भिन्द भिन्द, सर्वविषं छिन्द छिन्द, सर्वकुरुमृगं छिन्द छिन्द, सर्वशाकिनी
 छिन्द छिन्द, श्रीपार्श्वजिनपदाम्भोजभृङ्गि नमो दत्ताय देवी नमः । ॐ ह्रीं ह्रीं हूं ह्रीं हः
 स्वाहा । सर्वजनराज्यस्त्रीपुरुषवश्यं सर्व २ ॐ आँ क्रीं ह्रीं ऐं क्लीं ह्रीं देवि ! पद्मावति !

त्रिपुरकामसाधिनी दुर्जनमतिविनाशिनी त्रैलोक्यक्षोभिनी श्रीपार्श्वनाथोपसर्गहारिणी क्लीं
ब्लूं मम दुष्टान् हन हन, मम सर्वकार्याणि साधय साधय हुं फट् स्वाहा ।

भाँ क्रौं ह्रीं क्लीं ह्रौं पद्मे ! देवि ! मम सर्वजगद्वश्यं कुरु कुरु सर्वविघ्नान् नाशय
नाशय पुरक्षोभं कुरु कुरु, ह्रीं संवौषट् स्वाहा ।

ॐ आँ क्रौं ह्रौं द्रौं द्रीं क्लीं ब्लूं सः ह्रूं पद्मावती सर्वपुरजनान् क्षोभय क्षोभय
मम पादयोः पातय पातय, आकर्षणी ह्रीं नमः ।

ॐ ह्रीं क्रौं अहं मम पापं फट् दह दह हन हन पच पच पाचय पाचय हं ब्भं
ब्भां क्ष्वीं हंसं व्भं वंह्यं यहः क्षां क्षीं क्षूं क्षैं क्षौं क्षं क्षः क्षि ह्रीं ह्रीं हं हे हौं हौं
हं हः हिः हिं द्रां द्रीं द्रावय द्रावय नमोऽर्हते भगवते श्रीमते ठः ठः मम श्रीरस्तु,
पुष्टिरस्तु, कल्याणमस्तु स्वाहा ॥

इति श्रीपद्मावतीदण्डकसम्पूर्णम् ॥

श्रीपद्मावतीपटलम् ।

श्रीमन्माणिक्यरश्मिफणगणमुकुटे ! पद्मपत्रायताक्षि !

हाँ ह्रीं ह्रौंकारनादे हहहहहसिते ! हन्महाट्टट्टहासे ! ।

हाँ ह्रीं ह्रौं हः वहत्संवरवरवरणे धारिणे वज्रहस्ते !

पद्मे ! पद्मासनस्थे ! प्रहसितवदने ! देवि ! मां रक्ष पद्मे ! ॥१॥

क्षाँ क्षीं क्षूं क्षौं क्षैं क्षः क्षमलवरयुते ! पिण्डबीजत्रिनेत्रे !

क्षाँ क्षीं क्षौं क्षिप्रक्षिप्रे ! तुरतुरगमने ! नागिनीनाशपाशे ! ।

क्षाँ क्षीं क्षूं क्षौं क्षैं क्षः दिक्षु क्षुभितदशदिशाबन्धनं वज्रहस्ते !

रौद्रे त्रैलोक्यनाथे ! प्रहसितवदने ! देवि ! मां रक्ष पद्मे ! ॥२॥

घ्राँ घ्रीं घ्रौं घोररूपे घिणिघिणिघिणिते घण्टहोङ्कारनादे !

क्लीं ख्लीं ग्लीं घ्रौं घुटीना घुलुघुलुघुलते ! घर्जघर्जप्रमत्ते ! ।

घं घं घं जुगमयन्ती दह दह पच मे कर्म निर्मूलयन्ती

दुष्टे दुष्टप्रहारे ! कहकहवदने देवि ! मां रक्ष पद्मे ! ॥३॥

क्ष्मं ढं ग्लौं मन्त्रमूर्ते ! फणिगणनिलये ! डाकिनीस्तम्भकारी

भ्राँ भ्रीं भ्रूं भ्रः भ्रमन्ते ! भुवि रविभुविते भूरिभूम्येकपादे ! ।

किं किं बिम्बं प्रचण्डे ! स्थिरवसससस कामिनीमोहपाशे ! ।

ॐकारे मन्त्रमूर्ते ! सुसुमगणयुते ! देवि ! मां रक्ष पद्मे ! ॥४॥

घ्राँ घ्रीं घ्रौं पद्महस्ते ! ग्रहकुलमथने ! डाकिनीसिंहनादे !

हं हं हं वायुवेगे हहहहहसिते ! हन्महाट्टट्टहासे ! ।

क्लीं ल्लीं ग्लीं ब्लीं प्रचण्डे ! चलिचलिचलिते ! चालिनी वज्रहस्ते !
 यं यं रं वं कराले ! मनु मनु मनुते देवि ! मां रक्ष पद्मे ! ॥५॥
 भ्राँ ध्रीं भ्रूं मर्दमर्दे ! प्रहरणचपले ! स्तम्भिनी कामरूपे !
 छ्राँ छ्रीं छ्रूं वज्रहस्ते ! मणिमुकुटमये ! द्योतिदंष्ट्राकराले ! ।
 ब्लौं ब्लीं ब्लूं ब्रह्मासूत्रे ! जजजजजजये ! कालिनी कालमुद्रे !
 दिव्ये ! दिव्यावतारे ! कुरु कुरु वदने ! देवि ! मां रक्ष पद्मे ! ॥६॥
 म्लौं म्लीं म्लूं दिव्यरूपे ! चुरुचुरु चुरुते चारुणी चारुनेत्रे !
 श्रीं ह्रीं क्लींकारपिण्डे ! लललललवने ! पद्मिनी लम्बजिह्वे ! ।
 पादं बाहुं सहस्रे ! कलकलरहसे ! मात्रमाकाशगामि ! ।
 जां जां ज नागकन्ये ! त्रिभुवनविजये ! देवि ! मां रक्ष पद्मे ! ॥७॥
 ॐ ब्ल्यूं ब्राँ वज्रहस्ते ! गमगमगमने ! कामिनीमन्तरीक्षे !
 पद्मे पद्मप्रवासि ! सुरगणनमिते ! पद्मपत्राच्छनेत्रे !
 क्लीं ब्लौं ग्लीं ध्लीं रभश्चेत् कुरु कुरु वदने ! तन्महाट्टट्टहासे !
 वं हं सं शान्तिबीजं प्रहसितवदने ! देवि ! मां रक्ष पद्मे ! ॥८॥
 ॐ हं सं पङ्कजास्ये ! ललललसहिते ! रक्तपद्माभवर्ये !
 जूं भूं ह्रीं मोहनीये ! हिलिहिलिरमणे ! मर्द मर्द प्रमर्दे !
 दुष्टेनीकान्धकारे दह दह दहने ह्रौं ललाटायताक्षि !
 ह्रौं ह्रीं ह्रौं हं प्रसन्ने ! प्रहसितवदने ! देवि ! मां रक्ष पद्मे ! ॥९॥



परिशिष्ट. ६
द्विपञ्चाशदक्षरगर्भिता सप्रभावा
श्री पद्मावतीस्तुतिः

ॐ ॐ ॐ कारबीजं त्रिभुवनजयदा शक्तिरूपा प्रचण्डं
नानानानामनन्तं निजनिजनिजितां निर्भया निर्मलाङ्गी ।
मं मं मं मोक्षरूपं सकलजयकरं सर्वलीलाप्रसिद्धं
प्रं प्रं प्रं पद्मदेवि ! प्रकटघटमयं वन्दितं नाथ ! तत्त्वे ॥१॥
सं सं सं सिद्धिदाता हर हर हरती सर्वपापं हरन्ती
अं अं अं अङ्गअङ्गे अमलदलयुतं अङ्गरूपार्थयन्ती ।
आं आं आं अन्तरिक्षे अगमगमकरं अर्चितं आदिशक्तिः
प्रं प्रं प्रं पद्मदेवि ! प्रकटघटमयं वन्दितं नाथतत्त्वे ॥२॥
इं इं इं ईशपारं परमसिद्धिमयं आदिमाता कुमारी
ॐ ॐ ॐ ऊर्ध्वरूपं अकलकलिनितं आदिब्रह्माण्डमण्डे ! ।
रं रं रं राजलीला रमणरितरिते रूपरम्भा रमन्ती
प्रं प्रं प्रं पद्मदेवि ! प्रकटघटमयं वन्दितं नाथ तत्त्वे ॥३॥
रां रां रां रुद्राणी रिरिररिरवितां रक्तवेपं धरन्ती
लं लं लं लोललोलं ललिललिललितां लोकलीलाललामं ।
लं लं लं लब्धिदाता दलिदलिदलिता दुर्गतिं घोरदुष्टं
प्रं प्रं प्रं पद्मदेवि ! प्रकटघटमयं वन्दितं नाथ तत्त्वे ॥४॥
हं हं हं हेश्वर्यमाया त्रिभुवनरचिता निर्गुणानन्तशक्तिः
ॐ ॐ ॐ कारयुक्तं सकलसिद्धिकरं देवदेवेन्द्रवन्द्ये ! ।
अं अं अं आदिमाता अमरतरवरं आदिब्रह्मादिमर्त्यैः ।
प्रं प्रं प्रं पद्मदेवि ! प्रकटघटमयं वन्दितं नाथ तत्त्वे ॥५॥

कं कं कं कालहंते ! कलिमलरहिते ! कामनाकर्मसिद्धिः
 खं खं खं खड्गहस्ते ! खलबलहतयो खण्डिता खप्रपूरं ।
 गं गं गं गौरवर्णे गजनतगमनं गर्जितां घोषशब्दे !
 प्रं प्रं प्रं पद्मदेवि ! प्रकटघटमयं वन्दितं नाथ तत्त्वे ॥६॥
 घं घं घं घायदैत्ये घघघघटिकं घर्घरं घोररूपे !
 ङं ङं ङं ङंभरूपे ङङ्ङिङ्ङिङ्ङितां दीगचेन्द्रो ङङ्ङन्ती ।
 चं चं चं चक्रहस्ते ! चुरिचुरिचुरितां कष्टकं चूर्णयन्ती
 प्रं प्रं प्रं पद्मदेवि ! प्रकटघटमयं वन्दितं नाथ तत्त्वे ॥७॥
 छं छं छं छत्रमण्डे ! शिरमुकुटधरं शोभितं चन्द्रबिम्बं
 जं जं जं जोगमाया जय जय जयतां युग्मरूपे ! भवानी ।
 झं झं झं झुम्बरूम्ले ! झमझमझडितां झोठझूठे रुडन्ती
 प्रं प्रं प्रं पद्मदेवि ! प्रकटघटमयं वन्दितं नाथ तत्त्वे ॥८॥
 ञं ञं ञं नादबिन्दे नडिनडिनडितां दुष्टकथा नडन्ती
 टं टं टं टोपपूरे ! त्रिभुवनतरसे त्रासटङ्कारबाणम् ।
 ठं ठं ठं ठोरठोरे ठहठहठहकं घोरघोरं घुघन्ती
 प्रं प्रं प्रं पद्मदेवि ! प्रकटघटमयं वन्दितं नाथ तत्त्वे ॥९॥
 डं डं डं डाकडोरे ! डहडहडहकं द्रोतद्रोटाः करन्ती
 ढं ढं ढं दुङ्कमण्डे ढढढढढितो दुढडा ढाढयन्ती ।
 णं णं णं णार्यघाढे रणरणरणिता दुष्टपापं दुरन्ती
 प्रं प्रं प्रं पद्मदेवि ! प्रकटघटमयं वन्दितं नाथ तत्त्वे ॥१०॥
 तं तं तं तत्त्वमाया त्रिगुणगुणमयी ताडता भूतचक्रं
 थं थं थं थूललोके थुणथुणथुणितां सर्वदेवा स्थुणन्ती ।
 दं दं दं दीर्घरूपं दुरिदुरिदुरितां दुष्टपापं दुरन्ती
 प्रं प्रं प्रं पद्मदेवि ! प्रकटघटमयं वन्दितं नाथ तत्त्वे ॥११॥
 धं धं धं धर्मदीपे धरधरधरणीं धारिते धर्मवृद्धिं
 नं नं नं नर्कहन्ती निर्मलपटधरं मोक्षमण्डाणतत्त्वम् ।
 प्रं प्रं प्रं पद्मधारी पृथुलदलमयं पद्मपद्मासनस्थे ! ।
 प्रं प्रं प्रं पद्मदेवि ! प्रकटघटमयं वन्दितं नाथ तत्त्वे ॥१२॥
 फं फं फं फोजमध्ये जयजयजयदा शक्तिसामर्थ्यदाता
 बं बं बं बालरूपे ! बहबहबहके बाललीलाः करन्ती ।
 भं भं भं भ्रूमध्ये भजभजभजतां शोभि सिन्दूरबिन्दे
 प्रं प्रं प्रं पद्मदेवि ! प्रकटघटमयं वन्दितं नाथ तत्त्वे ॥१३॥

मं मं मं माल्यपुष्पैः मृगमदरचितां मौक्तिकैः शोभ्यमानं
 यं यं यं ज्योतिरंगे झगिझगिझगितां ज्योतिकं दर्परूपे ! ।
 रां रां रां रक्तवर्णं रचिरचिरचितां रक्तरङ्गारुणन्ती
 प्रं प्रं प्रं पद्मदेवि ! प्रकटघटमयं वन्दितं नाथतत्त्वे ॥१४॥
 लं लं लं लोकमाता त्रिभुवनजननी ब्रह्मविष्णुर्जनन्ती
 वं वं वं वेदशक्तिर्विमलवरवरं वज्रवज्रांकुशीनाम् ।
 शं शं शं शम्भुरूपी शिखरगिरिमयं शङ्करी शं करन्ती
 प्रं प्रं प्रं पद्मदेवि ! प्रकटघटमयं वन्दितं नाथतत्त्वे ॥१५॥
 पं पं पं पेलमण्डे षटदलरचितां दर्शनं खड्गपालं
 सं सं सं सिद्धशक्तिः शुक्लपदभवे ! सिद्धियोगं भजन्ती ।
 हौं हौं हौंकारनादे हरिहरि शिव मे सर्वपूज्ये प्रपूज्यं
 प्रं प्रं प्रं पद्मदेवि ! प्रकटघटमयं वन्दितं नाथतत्त्वे ॥१६॥
 क्षं क्षं क्षं क्षोभक्षोभं षटमतजयदा दुष्टदण्डे ! प्रचण्डे !
 क्रौं क्रौं क्रौं कालपन्थे ! किलिकिलिकिलिके किल्कमन्त्रैः समन्त्रैः ।
 प्रां प्रां प्रां पद्मकोणे षटदलजपते क्रूरतापे दयन्ती
 प्रं प्रं प्रं पद्मदेवि ! प्रकटघटमयं वन्दितं नाथतत्त्वे ॥१७॥
 ग्रं ग्रं ग्रं गोलचक्रं गुरुगुरुगुरुते गर्जगर्जेति गर्जे
 ज्रं ज्रं ज्रं ज्वालमाला ज्वलज्वलज्वलितां ज्योतिज्वालास्वरूपं ।
 त्रं त्रं त्रं ताडिताडि तडतडतडितां तारिता मन्त्रतन्त्रैः
 प्रं प्रं प्रं पद्मदेवि ! प्रकटघटमयं वन्दितं नाथतत्त्वे ! ॥१८॥
 द्रं द्रं द्रं द्रावयन्ती सकलभयभयान् भूर्यपद्मा भजन्ती
 प्रं प्रं प्रं पारिजातैः परमसुखविधे ! पूज्यते पद्मदेवि ! ।
 भ्रं भ्रं भ्रं भूतमाता भ्रमणभवहते ! ज्ञानदे ! गौरमङ्गं
 प्रं प्रं प्रं पद्मदेवि ! प्रकटघटमयं वन्दितं नाथतत्त्वे ॥१९॥
 झं झं झं मन्त्रमूर्तिर्मुगतपदमयं अर्चितं योगपन्थैः
 यूं यूं यूं ज्योतिमूर्तिं घटवरकमले ! चक्रपात्रे ! स्वरूपा ।
 थ्रं थ्रं थ्रं सिद्धियोगे कनकघटपटे पार्श्वनाथ प्रतापात्
 प्रं प्रं प्रं पद्मदेवि ! प्रकटघटमयं वन्दितं नाथतत्त्वे ॥२०॥
 ह्रौं ह्रौं ह्रौं ह्रीं य बीजं श्रियश्रियश्रिपदं श्रीकक्षोकारजाप्यं
 ॐ ह्रौं श्री कल्लं कमलस्थितिकरे सर्वजाप्यं जपन्ती ।
 ॐकारे सर्वबीजे समरनितनिते बावन्नामक्षरीणं
 प्रं प्रं प्रं पद्मदेवि ! प्रकटघटमयं वन्दितं नाथतत्त्वे ॥२१॥

आद्येशो चिद्ब्रह्मनन्तगुण भगवती भग्वंतज्योतिर्मयं
 आनन्दे युतभक्तिघन्तकमलायुक्तः स्वरूपोन्नतम् ।
 कृष्णचन्द्रविभूषणं गुणवतं त्रैलोक्यमाता सती
 ज्ञानादि मुनिचन्द्रनाथ भजतीते मर्चिता लीलामयम् ॥२२॥
 रुद्राणी जगरूपरम्भरमती त्रैलोक्यदेवेश्वरी
 ब्रह्मा विष्णुमहेशजन्महरणी युग्मेव योगेश्वरी ।
 मातङ्गी त्रिगुणादिनन्त विमला वाक्यंतवाघेश्वरी
 भग्वंती मुनिचन्द्रमात् मधुमती मानन्द आदेश्वरी ॥२३॥
 जगदम्बा युगयोगिणी जयवतं मुक्तामणीभूषणं
 खङ्गखप्रत्रिशूलवक्रमृगपतिमारूढरक्ताम्बरी ।
 दैत्येन्द्रहतरक्तबीजमथनी देव्येन्द्रदाता सुखं
 आनन्दी मुनिचन्द्रनाथनितजप्यं मुक्तेः पदं दायिनी ॥२४॥
 विविधनीतियुतं जगवल्लभं
 भगवती कीर्तिं बहुतपते जयम् ।
 दुरितपापहरं अमरापदं
 मुनिभिश्चन्द्रकलाकमलायुतम् ।
 सर्वपापहरं नित्यं सिद्धिर्भवति निश्चितम् ।
 प्रातरुत्थाय यः पठेत् अमरपदमाश्रितम् ॥२५॥ः



÷ नास्ति स्तोत्रमिदं शुद्धसंस्कृतं छन्दोदोषविमुक्तं च, तथापि शब्दचित्रत्वात् संगृहीतमिह
 विदुषां मनोविनोदाय ।

परिशिष्ट ७

पद्मावतीमन्त्राम्नायविधिः ।



ॐ ह्रीं श्रीं अर्हं नमिऊण पास विसहर वसहजिण फुर्लिग श्रीं ह्रीं (अर्हं) नमः । ॐ ॥

अस्य श्रीपार्श्वचिन्तामणिमन्त्रस्य पार्श्व ऋषिः, गायत्री छन्दः, श्रीधरणेन्द्रपद्मावती देवता, माया वीजं, श्रीः शक्तिः, अर्हं कीलकम्, मम सकलसिद्धिप्राप्त्यर्थं जपे विनियोगः ।

ॐ अर्हं श्रीं ह्रीं अङ्गुष्ठाभ्यां नमः ।

नमिऊण पासविसहर तर्जनीभ्यां नमः ।

वसहजिण मध्यमाभ्यां नमः ।

फुर्लिग अनामिकाभ्यां नमः ।

ह्रीं श्रीं कनिष्ठिकाभ्यां नमः ।

अर्हं नमः करतलपृष्ठाभ्यां नमः ।

॥ इति करन्यासः ॥

अथाङ्गन्यासः—

ॐ अर्हं श्रीं ह्रीं हृदयाय नमः ।

नमिऊण पास विसहर शिरसे स्वाहा ।

वसहजिण शिखायै वषट् ।

फुर्लिग कवचाय ।

ह्रीं श्रीं नेत्रत्रयाय वौषट् ।

अर्हं नमः अस्त्राय फट् ।

अथ ध्यानम्—

कमटे धरणेन्द्रे च स्वोचितं कर्म कुर्वति ।

प्रभुस्तुल्यमनोवृत्तिः पार्श्वनाथः श्रियेऽस्तु वः ।

ॐ अहं श्रीं ह्रीं नमिऊण पास विसहर वसहजिण फुलिग ह्रीं श्रीं अहं नमः ।

॥ श्रीरस्तु ॥

ॐ अमृते अमृतोद्भवे इत्यादि पूर्वमेव लिखितम् ।

अनेन जलमभिमन्त्र्य वार ७ वाम हस्तेन आरमशरीरं स्पर्शयेत्

जलाभिमन्त्रणमन्त्रः ॥१॥

ॐ नमो भगवते श्रीपार्श्वेन्द्राय ह्रीं स्वाहा ।

अनेन मन्त्रेण श्रीपार्श्वनाथं पूजयेत् । ॥ पूजामन्त्रः ॥२॥

ॐ ह्रीं गुरुपादुकाभ्यो नमः । गुरुपादुकामन्त्रः ॥ ३ ॥

ॐ ह्रीं अत्र स्वक्षेत्रपालाय नमः ॥ क्षेत्रपालमन्त्रः ॥ ४ ॥

क्षिप ॐ स्वाहा हा स्वा ॐ पक्षि । ॐ हौं ह्रीं ह्रूं ह्रों ह्रों ह्रः दक्षिणकर्णे । ॐ ह्रूं शिरःपश्चिमभागे ।

ॐ ह्रः मस्तकोपरि । ॐ क्ष्मों नेत्रयोः । ॐ क्ष्मीं मुखे । ॐ क्ष्मूं कण्ठे । ॐ क्ष्मों हृदये । ॐ क्ष्मः बाह्वोः । ॐ क्रौं उदरे । ॐ ह्रीं कट्याम् ।

ॐ ह्रूं जङ्घयोः । ॐ क्ष्में पादयोः । ॐ क्षः हस्तयोः । पृष्ठे मणिभद्रो रक्षतु ॥ अङ्गन्यासमन्त्रः ॥

ॐ ह्रीं अस्त्राय फट् फट् अस्त्रायनमः । करच्छोटिकामन्त्रः । अस्त्रः ।

ॐ नमो भगवति पद्मावति एहि एहि ह्रीं स्वाहा । आह्वानमन्त्रः । ॐ नमो भगवति ! देवि ! पद्मे ! अत्र सन्निहिता भव । स्थापनमन्त्रः ।

ॐ नमो भगवति ! देवि ! पद्मावति ! ह्रीं गन्धादीन् गृह्ण गृह्ण । अनेन मन्त्रेण पूजयेत् । अर्चनमन्त्रः ।

चतुर्भुजां ध्यायेद्देवीं अभयवरदपाशाङ्कुशाहिमुद्राः ।

ॐ आं क्रौं ह्रीं ऐं ह्रीं ह्रौं देवि ! पद्मे ! मम सर्वं जगद् वश्यं कुरु कुरु, सर्व-विघ्नान् नाशय नाशय, परक्षोभं कुरु कुरु, ह्रीं संवौषट् । मुद्रा बद्ध्वा पूजानन्तरं परिजाप्य मूलमन्त्रः नैवेद्ये । अग्निकार्ये तु स्वाहान्तम् । विद्वेषे ह्रूंकारान्तम् । शान्तिके वौषट्, पौष्टिके संवौषट् । वशीकरणे वषट् । पूजायां जापे च रक्तकणवीरपुष्पैः द्वादश सहस्र १२००० पूजा । त्रिसन्ध्यं जपेत् । सिद्धिर्भवेत् वेला ७ ध्यायेत् ध्यानकाले त्रिसन्ध्यम् । मूलमन्त्रः ।

ॐ नमो भगवति ! देवि ! पद्मावति ! स्वस्थानं गच्छ गच्छ फट् । विसर्जनमन्त्रः ।

ॐ आं क्रौं देवि ! पद्मे ! ॐ ह्रीं ह्रस्क्लह्रीं द्रां द्रीं क्लीं ब्लू सः ।

एभिर्बाणैः अमुकं वशमानय आनय ह्रीं वषट् । इमां देवीं पद्मावतीं रात्रौ ताम्बूल-भृताननः स्वाङ्गे विन्यस्य यादृग्विधा देवी तादृग्विधमात्मानं परिकल्पयेत् । मन्त्रं यस्यो-

परि जापः क्रियते सा स्त्री पादलग्ना ध्यानाद् वशीभवति । आकृष्टा च आयाति ॥

ॐ विद्युज्जिह्वे० इत्यादि पूर्यतनपत्रे लिखितोऽस्ति, एकविंशतिवारान् जप्तेन पुर-
क्षोभो भवति । पुरक्षोभविद्या ।

पद्मावतीपूजाध्यानविधिः समाप्तः ॥

तृतीयविधानं लिख्यते—

ॐ नमो भगवति ! देवि ! पद्मावति ! एहि एहि ह्रीं स्वाहा ॥ आह्वानमन्त्रः ॥
ॐ नमो भगवति ! देवि ! पद्मे ! ह्रीं अत्र सन्निहिता भव भव ॥ स्थापनमन्त्रः ॥
ॐ नमो भगवति ! देवि ! पद्मावति ! ह्रीं गन्धादीन् गृह्ण गृह्ण ॥ अर्चनमन्त्रः ॥
ॐ नमो भगवति ! देवि ! पद्मावति ! स्वस्थानं गच्छ गच्छ फट् फट् ॥ विसर्जनमन्त्रः ॥
ऐं क्लीं ह्रौं पद्मावति मम सर्वं जगद् वशं कुरु कुरु ह्रीं संवोषट् ।
पूजायां जापे च रक्तकणवीरपुष्पैः द्वादश सहस्र १२००० पूजा त्रिसन्ध्यं सिद्धिर्भवति ॥
इति तृतीयविधिः ।

ॐ अहं नमः सिद्धं । ॐ ह्रीं पद्मावत्यै नमः । ॐ आं ऐं क्रौं क्लृं कामरूपे !
सर्वेश्वर्ये ! श्री हंसपद्मावत्यै ह्रीं नमः ।
ऐं क्लीं ह्रौं पद्मावती मम जगद् वश्यं कुरु कुरु ह्रीं संवोषट् स्वाहा । क्षिप ॐ
स्वाहा ह्रीं स्वाहा ॐ पक्षि ॐ ह्रीं ह्रीं ह्रौं ह्रौं ह्रौं ह्रः आत्मसकलीकरणमन्त्रः ।
ॐ आं क्रौं ह्रीं ऐं क्लीं ह्रौं देवि ! पद्मे ! नमः ! इत्यादि न्यासः ।
ॐ ह्रीं अस्त्राय फट् फट् अस्त्राय नमः । करमध्यात् छोटिका अस्त्रम् ।
ॐ नमो भगवति ! एहि एहि ह्रीं स्वाहा । आह्वानमन्त्रः ।
ॐ नमो भगवति ! देवि ! पद्मे ! ह्रीं अत्र सन्निहिता भव भव स्थापनमन्त्रः ॥
ॐ नमो भगवति ! देवि ! पद्मावति ! ह्रीं गन्धादीन् गृह्ण गृह्ण अर्चनमन्त्रः ॥ मुद्राः ॥
ॐ नमो भगवति ! देवि ! पद्मावति ! स्वस्थानं गच्छ गच्छ फट् ।
विसर्जनमन्त्रः ।

ऐं क्लीं ह्रौं पद्मावति ! मम सर्वजगद्वशं कुरु कुरु ह्रीं संवोषट् मन्त्रोऽयं नैवेद्ये,
अग्निकार्यं तु स्वाहान्तं । विद्वेषे होंकारान्तम् । शान्तिके वौषट् ।

ॐ आं क्रौं ह्रीं ऐं क्लीं ह्रौं ॐ द्रां द्रीं पद्मे ! पद्मकटिनी अमुकस्य बन्दिमोक्षं
कुरु कुरु स्वाहा । जातिपुण्यजापे बद्धो मुच्यते ।

ॐ आं क्रौं ह्रीं ऐं क्लीं ह्रौं देवि ! पद्मे । सर्वजगद्वशं कुरु कुरु, सर्वविघ्नान्
नाशय नाशय, पुरक्षोभं कुरु कुरु, ह्रीं संवोषट् स्वाहा । प्रत्यहं स्मरणात् शुभं भवति ॥

पौष्टिके संवोषट्, वशीकरणे वषट्, पूजायां जापे च रक्तकणवीरकुसुमैः द्वादश
सहस्र १२००० पूजा त्रिसन्ध्यम् । सिद्धिर्भवति ।

ॐ विद्युज्जिह्वे ज्वालामुखी ज्वालिनी ज्वल ज्वल, प्रज्वल प्रज्वल, धग धग, धूमान्धकारिणी देवी पुरक्षोभं कुरु कुरु, मनश्चिन्तितं कारय २ ऐं ह्रीं हः क्लीं क्षोभिणी नमः ।
एकविंशतिवारान् परिजप्तेन पुरक्षोभो भवति । सम्प्रति पद्मावतीमहादेव्याः कल्पो
लिख्यते, स चायम्—

ॐ अमृते ! अमृतोद्भवे ! अमृतवर्षिणि ! अमृतवाहिनि ! अमृतं स्रावय स्रावय
स्वाहा ॥ जलाभिमन्त्रणम् ॥

ॐ ह्रीं नमः । मूलसिद्धिः । स्वाहा स्नानमन्त्रः ॥

॥ इति श्रीपद्मावतीमन्त्राक्षराणि सम्पूर्णानि ॥



परिशिष्ट ८

श्रीपद्मावतीसहस्रनामस्तोत्रम्

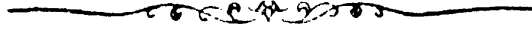

प्रणम्य परया भक्त्या देव्याः पादाम्बुजं त्रिधा ।

नामान्यष्टसहस्राणि वक्ष्ये तद्भक्तिहेतवे ॥१॥

श्रीपार्श्वनाथचरणाम्बुजचञ्चरीका भव्यान्धनेत्रविमलीकरणे शलाका ।

नागेन्द्रप्राणधरणीधरधारणाभूत् मां पातु सा भगवती नितरामघेभ्यः ॥२॥

पद्मावती पद्मवर्णा पद्महस्तापि पद्मिनी ।

पद्मासना पद्मकर्णा पद्मास्या पद्मलोचना ॥३॥

पद्मा पद्मदलाक्षी च पद्मी पद्मवनस्थिता ।

पद्मालया पद्मगन्धा पद्मरागोपरागिका ॥४॥

पद्मप्रिया पद्मनाभिः पद्माङ्गा पद्मशायिनी ।

पद्मवर्णवती पूता पवित्रा पापनाशिनी ॥५॥

पद्मावती प्रसिद्धा च पार्वती पुरवासिनी ।

प्रज्ञा प्रह्लादिनी प्रीतिः पीताभा परमेश्वरी ॥६॥

पातालवासिनी पूर्णा पद्मयोनिः प्रियंवदा ।

प्रदीप्ता पाशहस्ता च परा पारा परंपरा ॥७॥

पिङ्गला परमा पूरा पिङ्गा प्राची प्रतीचिका ।

परकार्यकरा पृथ्वी पार्थिवी पृथिवी पवी ॥८॥

पल्लवा पानदा पात्रा पवित्राङ्गी च पूतना ।

प्रभा पताकिनी पीता पद्मगाधिपशेखरा ॥९॥

पताका पद्मकटिनी पतिमान्यपराक्रमा ।

पदाम्बुजधरा पुष्टिः परमागमबोधिनी ॥१०॥

परमात्मा परानन्दा परमा पात्रपोषिणी ।

पञ्चवाणगतिः पौत्री पाषण्डघ्नी पितामही ॥११॥
 प्रहेलिकापि प्रत्यञ्चा पृथुपापौघनाशिनी ।
 पूर्णचन्द्रमुखी पुण्या पुलोमा पूर्णिमा तथा ॥१२॥
 पावनी परमानन्दा पण्डिता पण्डितेडिता !
 प्रांशुलभ्या प्रमेया च प्रभा प्राकारवर्तिनी ॥१३॥
 प्रधाना प्रार्थिता प्रार्थ्या पद्दा पङ्क्तिवर्जिनी ।
 पातालस्येश्वरप्राणप्रेयसी प्रणमामि ताम् ॥१४॥

इति पद्मावतीशतम् ।

महाज्योतिर्मती माता महामाया महासती ।
 महादीप्तिमती मित्रा महाचण्डी च मङ्गला ॥१॥
 महिषी मानुषी मेघा महालक्ष्मीर्मनोहरा ।
 महाप्रहारनिम्नाङ्गा मानिनी मानशालिनी ॥२॥
 मार्गदात्री मुहूर्ता च माध्वी मधुमती मही ।
 महेश्वरी महेश्या च मुक्ताहारविभूषणा ॥३॥
 महामुद्रा मनोज्ञा च महाश्वेतातिमोहिनी ।
 मधुप्रिया मतिर्माया मोहघ्नी च मनस्विनी ॥४॥
 माहिष्मती महावेगा मानदा मानहारिणी ।
 महाप्रभा च मदना मन्त्रवद्व्या मुनिप्रिया ॥५॥
 मन्त्ररूपा च मन्त्रज्ञा मन्त्रदा मन्त्रसागरा ।
 मधुप्रिया महाकाया महाशीला महाभुजा ॥६॥
 महासना महारम्या मनोभेदा महासमा ।
 महाकान्तिधरा मुक्तिर्महाव्रतसहायिनी ॥७॥
 मधुश्रवा मूर्च्छना च मृगाक्षी च मृगावती ।
 मृणालिनी मनःपुष्टिर्महाशक्तिर्महार्थदा ॥८॥
 मूलाधारा मृडानी च मत्तमातङ्गगामिनी ।
 मन्दाकिनी महाविद्या मर्यादा मेघमालिनी ॥९॥
 मातामही मन्दगतिः महाकेशी महीधरा ।
 महोत्साहा महादेवी महिला मानवर्द्धिनी ॥१०॥
 महाग्रहहरा मारी मोक्षमार्गप्रकाशिनी ।
 मान्या मानवती मानी मणिनूपुरशेखरा (०शोभिनी) ॥११॥
 मणिकाञ्चीधरा माना महामतिप्रकाशिनी ।
 ईडेश्वरी दिज्येच्छेखे खेन्द्राणी कालरूपिणी ॥१२॥

इति महाज्योतिर्मतीशतम् ॥

जिनमाता जिनेन्द्रा च जयन्ती जगदीश्वरी ।
 जया जयवती जाया जननी जनपालिनी ॥१॥
 जगन्माता जगन्माया जगज्जैत्री जगज्जिता ।
 जगरा जर्जरा जैत्री यमुनाजलभासिनी ॥२॥
 योगिनी योगमूला च जगद्धात्री जलन्धरा ।
 योगपट्टधरा ज्वाला ज्योतीरूपा च जालिनी ॥३॥
 ज्वालामुखी ज्वालमाला ज्वलिनी च जगद्धिता ।
 जैनेश्वरी जिनाधारा जीवनी यशपालिनी ॥४॥
 यशोदा ज्यायसी जीर्णा जर्जरा ज्वरनाशिनी ।
 ज्वररूपा जरा जीर्णा जाङ्गलाऽऽमयर्तजिनी ॥५॥
 युगभारा जगन्मित्रा यन्त्रिणी जन्मभूषिणी ।
 योगेश्वरी च योगाङ्गा योगयुक्ता युगादिजा ॥६॥
 यथार्थवादिनी जाम्बूनदकान्तिधरा जया ।
 नारायणी नर्मदा च निमेषा नर्त्तिनी नरी ॥७॥
 नीलानन्ता निराकारा निराधारा निराश्रया ।
 नृपवश्या निरामान्या निःसङ्गा नृपनन्दिनी ॥८॥
 नृपधर्ममयी नीतिः तोतला नरपालिनी ।
 नन्दा नन्दिवती निष्ठा नीरदा नागवल्लभा ॥९॥
 नृत्यप्रिया नन्दिनी च नित्या नेका निरामिषा ।
 नागपाशधरा नौका निःकलङ्का निरागसा ॥१०॥
 नागवल्लो नागकन्या नागिनी नागकुण्डली ।
 निद्रा च नागदमनी नेत्रा नाराचवर्षिणी ॥११॥
 निर्विकारा च निर्धरा नागनाथेशवल्लभा ।
 निर्लोभा च नमस्तुभ्यं नित्यानन्दविधायिनी ॥१२॥

इति जिनमाताशतम् ॥

वज्रहस्ता च वरदा वज्रशीला वरूथिनी ।
 वज्रा वज्रायुधा वाणी विजया विश्वव्यापिनी ॥१॥
 वसुदा बलदा वीरा विषया विषवर्द्धिनी ।
 वसुन्धरा वरा विश्वा वर्णिनी वायुगामिनी ॥२॥

बहुवर्णा बीजवती विद्या बुद्धिमती विभा ।
 वेद्या वामवती वामा विनिद्रा वंशभूषणा ॥३॥
 वरारोहा विशोका च वेदरूपा विभूषणा ।
 विशाला वारुणीकल्पा बालिका बालकप्रिया ॥४॥
 वर्तिनी विपहा बाला विविक्ता वनवासिनी ।
 वन्द्या विधिसुता बाला विश्वयोनिर्बुधप्रिया ॥५॥
 बलदा वीरमाता च वस्तुदा वीरनन्दिनी ।
 वरायुधधरा वेषी वारिदा बलशालिनी ॥६॥
 बुधमाता वैद्यमाता बन्धुरा बन्धुरूपिणी ।
 विद्यावती विशालाक्षी वेदमाता विभास्वरी ॥७॥
 वात्याली विषमा वेषा वेदवेदाङ्गधारिणी ।
 वेदमार्गरता व्यक्ता विलोमा वेदशालिनी ॥८॥
 विश्वमाता विकम्पा च वंशजा विश्वदीपिका ।
 वसन्तरूपिणी वर्षा विमला विविधायुधा ॥९॥
 विज्ञानिनी पवित्रा च विपञ्चो बन्धमोक्षिणी ।
 विपरूपघती वर्द्धा विनीता विशिखा विभा ॥१०॥
 व्यालिनी व्याललीला च व्याप्ता व्याधिविनाशिनी ।
 विमोहा बाणसन्दोहा वर्द्धिनी वर्द्धमानका ॥११॥
 ईशानी तोतरा भिद्रा वरदायी नभोऽस्तु ते ।
 व्यालेश्वरी प्रियप्राणा प्रेयसी वसुदायिनी ॥१२॥

इति वज्रहस्ताशतम् ॥

कामदा कमला काम्या कामाङ्गा कामसाधिनी ।
 कलावती कलापूर्णा कलाधारा कनीयसी ॥१॥
 कामिनी कमनीयाङ्गा कणत्काञ्चनसन्निभा ।
 कात्यायनी कान्तिदा च कमला कामरूपिणी ॥२॥
 कामिनी कमलामोदा कम्प्रा कान्तिकरी प्रिया ।
 कायस्था कालिका काली कुमारी कालरूपिणी ॥३॥
 कालाकारा कामधेनुः काशी कमललोचना ।
 कुन्तला कनकाभा च काश्मीरा कुङ्कुमप्रिया ॥४॥
 कृपावती कुण्डलिनी कुण्डलाकारशायिनी ।
 कर्कशा कोमला काली कौलिकी कुलबालिका ॥५॥

कालचक्रधरा कल्पा कालिका काव्यकारिका ।
 कविप्रिया च कौशाम्बी कारिणी कोशवर्द्धिनी ॥६॥
 कुशावती किरालाभा कोशस्था कान्तिवर्द्धिनी ।
 कादम्बरी कठोरस्था कौशाम्बा कोशवासिनी ॥७॥
 कालघ्नी कालहननी कुमारजननी कृतिः ।
 कैवल्यदायिनी केका कर्महा कालवर्जिनी ॥८॥
 कलङ्करहिता कन्या करुणालयवासिनी ।
 कर्पूरामोदिनिःश्यासा कामबीजवती करा ॥९॥
 कुलोना कुन्दपुष्पाभा कुर्कुटोरगवाहिनी ।
 कलिप्रिया कामबाणा कमठोपरिशायिनी ॥१०॥
 कठोरा कठिना क्रूरा कन्दला कदलीप्रिया ।
 क्रोधिनी क्रोधरूपा च चक्रहंकारवर्तिनी ॥११॥
 कम्बोजिनी काण्डरूपा कोदण्डकरधारिणी ।
 कुहू क्रीडयती क्रीडा कुमारानन्ददायिनी ॥१२॥
 कमलासना केतकी च केतुरूपा कुतूहला ।
 कोपिनी कोपरूपा च कुसुमावासवासिनी ॥१३॥

इति कामदाशतम् ॥

सरस्वती शरण्या च सहस्राक्षी सरोजगा ।
 शिवा सती सुधारूपा शिवमाया सुता शुभा ॥१॥
 सुमेधा सुमुखी शान्ता सावित्री सायगामिनी ।
 सुरोत्तमा सुवर्णा च श्रीरूपा शास्त्रशालिनी ॥२॥
 शान्ता सुलोचना साध्वी सिद्धा साध्या सुधात्मिका ।
 सारदा सरला सारा सुवेपा जशवर्द्धिनो ॥३॥
 शङ्करी शमिता शुद्धा शक्रमान्या शुभङ्करी ।
 शुद्धाहाररता श्यामा शीमा शीलवती शरा ॥४॥
 शीतला सुभगा सर्वा सुकेशी शैलवासिनी ।
 शालिनी साक्षिणी सीता सुभिक्षा शिवप्रेयसी ॥५॥
 सुवर्णा शोणवर्णा च सुन्दरी सुरसुन्दरी ।
 शक्तिस्तुषा सारिका च सेव्या श्रीः सुजनार्चिता ॥६॥
 शिवदूती श्वेतवर्णा शुभ्राभा शुभनाशिकी ।
 सिंहिका सकला शोभा स्वामिनी शिवपोषिणी ॥७॥

श्रेयस्करी श्रेयसी च शौरिः सौदामनी शुचिः ।
 सौभागिनी शोषणी च सुगन्धा सुमतःप्रिया ॥८॥
 सौरभेयी सुसुरभी श्वेतातपत्रधारिणी ।
 शृङ्गारिणी सत्यवक्ता सिद्धार्था शीलभूषणा ॥९॥
 सत्यार्थिनी च सन्ध्याभा शची संक्रान्तिसिद्धिदा ।
 संहारकारिणी सिंही सप्तर्चिः सफलार्थदा ॥१०॥
 सत्या सिन्दूरवर्णाभा सिन्दूरतिलकप्रिया ।
 सारङ्गा सुतरा तुभ्यं ते नमोऽस्तु सुयोगिनी ॥११॥

इति श्रीसरस्वतीशतम् ।

भवनेश्वरी भूषणा च भुवना भूमिप्रिया ।
 भूमिगर्भा भूपवन्द्या भुजङ्गेशप्रिया भगा ॥१॥
 भुजङ्गभूषणाभोगा भुजङ्गाकारशायिनी ।
 भवभीतिहरा भीमा भूमिर्भाद्रहासिनी ॥२॥
 भारती भवती भोगा भगिनी भोगमन्दिरा ।
 भद्रिका भद्ररूपा च भूतात्मा भूतभञ्जिनी ॥३॥
 भवानी भैरवी भीमा भामिनी भ्रमनाशिनी ।
 भुजङ्गिनी भ्रुसुण्डी च मेदिनी भूमिभूषणा ॥४॥
 भिन्ना भाग्यवती भासा भोगिनी भोगवल्लभा ।
 भुक्तिदा भक्तिग्राह्या च भवसागरतारणी ॥५॥
 भास्वती भास्वरा भूतिर्भूतिदा भूतिवर्द्धिनी ।
 भाग्यदा भोग्यदा भोग्या भाविनी भवनाशिनी ॥६॥
 भीक्षणा भट्टारका भीरुभ्रामरी भ्रमरी भवा ।
 भट्टिनी भाण्डदा भाण्डा भल्लाकी भूरिभञ्जिनी ॥७॥
 भूमिगा भूमिदा भाषा भक्षिणी भृगुभञ्जिनी ।
 भाराक्रान्ताभिनन्दा च भजिनी भूमिपालिनी ॥८॥
 भद्रा भगवती भर्गा वत्सला भगशालिनी ।
 खेचरी खड्गहस्ता च खण्डिनी खलमर्दिनी ॥९॥
 खट्वाङ्गधारिणी खड्वा खड्गा खगवाहिनी ।
 षट्त्रकभेदविख्याता खगपूज्या खगेश्वरी ॥१०॥
 लाङ्गली ललना लेखा लेखिनी ललना लता ।
 लक्ष्मीर्लक्ष्मवती लक्ष्या लाभदा लोभवर्जिता ॥११॥

इति भवनेश्वरीशतम् ।

लीलावती ललामाभा लोहमुद्रा लिपिप्रिया ।
 लोकेश्वरी च लोकाङ्गा लब्धिलोकान्तपालिनी ॥१॥
 लीला लीलाङ्गदा लोला लावण्या ललितार्थिनी ।
 लोभहा लम्बनिर्लङ्का लक्षणा लक्ष्यवर्जिता ॥२॥
 उमोर्वसी उदीची च उद्योतोद्द्योतकारिणी ।
 उद्धारण्या धरोदकयो दिव्योदकनिवासिनी ॥३॥
 उदाहारोत्तमातंसा औपध्युदधितारणी ।
 उत्तरोत्तरवादिभ्यो धराधरनिवासिनी ॥४॥
 उत्कीलिन्युत्कीलिनी च उत्कीर्णकाररूपिणी ।
 अकाराकाररूपा च अम्बिकाऽम्बरचारिणी ॥५॥
 आमोघा सा पुरी चान्ताऽणिमादिगुणसंयुता ।
 अनादिनिधनाऽनन्ता चातुलाटाऽट्टहासिनी ॥६॥
 अपर्णार्धविन्दुधरा लोकालल्याल्लिवाङ्गना ।
 आनन्दानन्ददा लोका राष्ट्रसिद्धिप्रदानका ॥७॥
 अव्यक्तास्त्रमयी मूर्त्तिरजीर्णा जीर्णहारिणी ।
 अहिकृत्य रजाजारा हुङ्काररातिरन्तिदा ॥८॥
 धनुरूपाथ मूर्तिघ्नी क्रीडा कैरवपालिनी ।
 अनोकहाशुगा भेद्या छेद्या चाकाशगामिनी ॥९॥
 अनन्तरा साधिकारा त्वाङ्गा अन्तरनाशिनी ।
 अलका यवना लङ्घया सीता शिखरधारिणी ॥१०॥
 अहिनाथप्रियप्राणा नमस्तुभ्यं महेश्वरी ।
 आकर्षण्याधरा रागा मन्दा मोदावधारिणी ॥११॥

इति लीलावतीशतम् ॥

त्रिनेत्रा त्र्यम्बिका तन्त्री त्रिपुरा त्रिपुरभैरवी ।
 त्रिपुष्टा त्रिफणा तारा तोतला त्वरिता तुला ॥१॥
 तपप्रिया तापसी च तपोनिष्ठा तपस्विनी ।
 त्रैलोक्यदीपका त्रेधा त्रिसन्ध्या त्रिपदाश्रया ॥२॥
 त्रिरूपा त्रिपदा त्राणा तारा त्रिपुरसुन्दरी ।
 त्रिलोचना त्रिपथगा तारा मानविमर्दिनी ॥३॥

धर्मप्रिया धर्मदा च धर्मिणी धर्मपालिनी ।
 धाराधरधराधारा धात्री धर्माङ्गपालिनी ॥४॥
 धौता धृतिधुरा धीरा धुनुनी च धनुर्धरा ।
 ब्रह्माणी ब्रह्मगोत्रा च ब्राह्मणी ब्रह्मपालिनी ॥५॥
 गङ्गा गोदावरी गौगा गायत्री गणपालिनी ।
 गोचरी गोमती गुर्वाङ्गाधा गान्धारिणी गुहा ॥६॥
 ब्राह्मी विशुत्प्रभा वीरा वीणावासवपूजिता ।
 गीतप्रिया गर्भधरा गायिनी गजगामिनी ॥७॥
 गरीयसी गुणोपेता गरिष्ठा गरमर्दिनी ।
 गम्भीरा गुरुरूपा च गीता गर्वापहारिणी ॥८॥
 ग्रहिणी ग्राहिणी गौरी गन्धारी गन्धवासना ।
 गारुडी प्रसिनी गूढा गौहनी गुणहायनी ॥९॥
 चक्रमध्या चक्रधरा चित्रणी चित्ररूपिणी ।
 चर्चरी चतुरा चित्रा चित्रमाया चतुर्भुजा ॥१०॥
 चन्द्राभा चन्द्रवर्णा च चक्रिणी चक्रधारिणी ।
 चक्रायुधा करधरा चण्डी चण्डपराक्रमा ॥११॥

इति त्रिनेत्राशतम् ॥

चक्रेश्वरी चमूश्चिन्ता चापिनी चञ्चलात्मिका ।
 चन्द्रलेखा चन्द्रभागा चन्द्रिका चन्द्रमण्डला ॥१॥
 चन्द्रकान्तिश्चन्द्रमश्रीश्चन्द्रमण्डलवर्तिनी ।
 चतुःसमुद्रपारान्ता चतुराश्रमवासिनी ॥२॥
 चतुर्मुखी चन्द्रमुखी चतुर्वर्णफलप्रदा ।
 चित्स्वरूपा चिदानन्दा चिराश्चिन्तामणिः पिता ॥३॥
 चन्द्रहासा च चामुण्डा चिन्तना चौरवर्जिनी ।
 चैत्यप्रिया चैत्यलीला चिन्तितार्थफलप्रदा ॥४॥
 ह्रीरूपा हंसगमनी हाकिनी हिङ्गुलाहिना ।
 हालाहलधरा हारा हंसवर्णा च हर्षदा ॥५॥
 हिमानी हरिता हीरा हर्षिणी हरिमर्दिनी ।
 गोपिनी गौरगीता च दुर्गा दुर्ललिता धरा ॥६॥
 दामिनी दीर्घिका दुग्धा दुर्गमा दुर्लभोदया ।
 द्वारिका दक्षिणा दीक्षा दक्षा दक्षातिपूजिता ॥७॥

दमयन्ती दानवती द्युतिदीप्ता दिवागतिः ।
 दरिद्रहा वैरिदूरा दारा दुर्गतिनाशिनी ॥८॥
 दर्पहा दैत्यदासा च दर्शिनी दर्शनप्रिया ।
 वृषप्रिया च वृषभा वृषारूढा प्रबोधिनी ॥९॥
 सूक्ष्मा सूक्ष्मगतिः श्लक्ष्णा घनमाला घनद्युतिः ।
 छाया छात्रच्छविच्छिरक्षीरदा क्षेत्ररक्षिणी ॥१०॥
 अमरी रतिरात्रिश्च रङ्गिनी रतिदा रुपा ।
 स्थूला स्थूलतरा स्थूला स्थण्डिलाशयवासिनी ॥११॥
 स्थिरा स्थानवती देवी घनघोरनिनादिनी ।
 क्षेमङ्करी क्षेमवती क्षेमदा क्षेमवर्द्धिनी ॥१२॥
 शैलूषरूपिणी शिष्टा संसारार्णवतारिणी ।
 सदा सहायिनी तुभ्यं नमस्तुभ्यं महेश्वरी ॥१३॥

इति चक्रेश्वरीशतम् ॥

नित्यं पुमान् पठति यो नितरां त्रिशुद्ध्या शौचं विधाय विमलं फणिशेखरायाः ।
 स्तोत्रं द्युनाथ उदिते सुसहस्रनाम चाप्रोत्तरं भवति सो भुवनाधिराजः ॥१॥
 तत्कालजातवरगोमयलिप्तभूमौ कुर्याद् दृढासनमतीन्द्रियपद्मकाख्यम् ।
 धूपं विधाय वरगुग्गुलुमाज्ययुक्तं रक्ताम्बरं वपुषि भूप्य मनः प्रशस्तः ॥२॥
 न तस्य रात्रौ भयमस्ति किञ्चिन्न शोकरोगोद्भवदुःखजालम् ।
 न राजपीडा न च दुर्जनस्य पद्मावतीस्तोत्रं निशम्यतां वै ॥३॥
 न बन्धनं तस्य न वह्निजातं भयं न चारेर्नृपतोऽपि किञ्चित् ।
 न मत्तनागस्य न केशरीभयं यो नित्यपाठी स्तवनस्य पद्मे ! ॥४॥
 न सङ्करे शस्त्रचयाभिघातः न व्याघ्रभीतिर्भुवि भीतिभोतिः ।
 पिशाचिनीनां न च डाकिनीनां स्तोत्रं रमायाः पठतीति यो वै ॥५॥
 न राक्षसानां न च शाकिनीनां न चापदा नैव दरिद्रता च ।
 न चास्य मृत्योर्भयमस्ति किञ्चित् पद्मावतीस्तोत्रं निशम्यतां वै ॥६॥
 स्नानं विधाय विधिवद् भुवि पार्श्वभर्तुः पूजां करोति शुचिद्रव्यचरैर्विधिभिः ।
 पद्मावती फलति तस्य मनोऽभिलाषं नानाविधं भवभवं सुखसारभूतम् ॥७॥
 सुपूर्वाह्नमध्याह्नसन्ध्यासु पाठं तथैवावकाशं भवेदेकचित्तः ।
 भवेत्तस्य लाभार्थं आदित्यवारे करोतीह भक्तिं सदा पार्श्वभर्तुः ॥८॥
 शुभापत्यलक्ष्मीर्नु वाजीन्द्रयूथा गृहे तस्य नित्यं सदा सञ्चरन्ति ।
 नवीनाङ्गनानां गणास्तस्य नित्यं शिवायाः सुनामावलियस्य चित्ते ॥९॥

ममाल्पबुद्ध्या स्तवनं विधाय करोमि भक्तिं फणिशेखरायाः ।
 यदर्थमन्त्राक्षरव्यञ्जनच्युतं, विशोधनीयं कृपया हि सद्भिः ॥१०॥
 भो देवि ! भो मात ! ममापराधं, संक्षम्यतां तत्स्तवनाभिधाने ।
 माता यथापत्यकृतापराधं संक्षम्यति प्रीत्यपलायनैक्यम् ॥११॥

- (१) ॐ ह्रीं श्रीं क्लीं ब्लौं कलिकुण्डस्वामिन् ! सिद्धिश्रियं जगद् वश्यमानय आनय
 स्वाहा ॥ १०८
- (२) ॐ ह्रीं ऐं श्रीं श्रीगौतमगणराजाय स्वाहा ॥ लक्ष १।
- (३) ॐ नमो चालिदेवि ! पद्मावति ! आकृष्टिकरणि ! कामचारि, मोहचारि, अबोलु
 बोलावि, अद्यनुं दिवारि, आणि पासि घालि दासु ॐ फट् स्वाहा ॥
 जाप २४ सहस्रं । प्रत्यहं १०८ जपनीयम् । वश्यम् ॥
- (४) ॐ आं ऐं क्रौं ह्रीं हंसरूपे ! सर्ववश्ये ! श्रीं सोहं पद्मावत्यै ह्रीं नमः प० । जापो-
 ऽयं दीपोत्सवे । घृतदीपोऽखण्डः रक्षणीयः । दिन ३ जाप २५ सहस्र कीजे । त० १२
 सहस्र कीजे । पंचामृत होम । सर्वार्थसिद्धि । नित्यपाठ २१

॥ शुभं भवतु ॥



परिशिष्ट ९

श्रीपद्मावतीस्तोत्रम् ।

जय जय जगदानन्ददायिनि ! जय जय धरणेन्द्रवल्लभे ! सुभगे ! ।
देवि ! फणत्रयधारिणि ! त्वं जय पद्मानने ! पद्मे ! ॥१॥
विजया जयाऽजिता त्वं अपराजिता शिवा गौरी ।
रम्भा त्वं वैरोढ्या प्रहसिर्भद्रकाली च ॥२॥
काली च महाकाली शिवङ्करी शङ्करी पद्मनेत्रा ।
हिमवत्तनया लक्ष्मीर्धृतिमतिभुवनेश्वरी देवी ॥३॥
त्वं बुद्धि-सिद्धि-वृद्धिस्त्वं ज्वालामालिनीश्वरी बाला ।
कामाक्षा जगदम्बा अम्बा जगदीश्वरी तारा ॥४॥
त्वमम्बिकाऽन्नपूर्णा श्रीविद्यात्रिपुरसुन्दरीजननी ।
त्वं भगवती भवानी मातङ्गी राजमातङ्गी ॥५॥
त्वं भैरवी त्रिनेत्री शक्तिस्त्वं हिङ्गुलाज-हीङ्गोली ।
त्वं वाग्वादिनीशारदा सरस्वती सत्यदेवी च ॥६॥
ज्वालामुखि भो बाला पीठा शाकम्भरी च त्वमनन्ता ।
शीतला तोतला भद्रा वज्रा कृष्माण्डी चक्रधरा ॥७॥
चामुण्डी महामाया गायत्री सर्वविश्वविख्याता ।
श्रुतदेवी जिनवाणी त्वं विद्या वर्द्धमानस्य ॥८॥
नागकुमारकुमारी देवी कात्यायनी मधुमती च ।
कुण्डलिनी ह्रींकारी आई माई च दुर्गोमा ॥९॥
भोगी चानन्दकरी त्वं वरदानन्ददायिनी नित्या ।
ब्रह्माणी बाहुबली सिंहमराले समारूढा ॥१०॥
त्वं चैकाक्षरनामा अक्षरी त्र्यक्षरी पञ्चक्षरी माता ।
पञ्चदशाक्षरगर्भिता त्वं भुवनत्रयस्य सौख्यकरी ॥११॥
त्रिजगन्नाभशरीरा जनजाड्यविभञ्जना रविकराभा ।
सेवकवाञ्छितफलदा पद्मदला भास्वरी सेव्या ॥१२॥
श्रीपार्श्वनाथपदपङ्कजभक्तिलीना पद्मासना प्रवरकुर्कुटसर्पयाना ।
दारिद्र्यदुःखरिपुवर्गविनाशनोक्ता पद्मावती भवतु मे खलु सा प्रसन्ना ॥१३॥

परिशिष्ट १०
श्रीजिनप्रभसूरिविरचिता
पद्मावतीचतुष्पदिका ।

जिनसासन अवधारि करेवि ज्ञायहुं सिरिपउमावइ देवी ।
भवियल्योयआणंद करेउ दुलहउ सावयजम्म लहेउ ॥१॥
मनरि मिच्छसूर अणुसरह
पासनाहपयपंकयभसलि ! संघविघननिन्नासणकुसलि ! ।
ससिकरनिम्मलगुणगणपुण्ण ! पउमपवि ! मह होउ पसण्ण ! ॥२॥
तारतरल तुह लोयण तिण्णि दुहदलणा भूयदुगण दुण्णि ।
पियसी पद्मरुहपविहत्थे वारण दीसे तुह हत्थी ॥३॥
फूलफालफणिमणिकरजाल दसदिसि पसरइ तुज्झ कराल ।
जिणिं दीठइं पडिबोहिय सहइ विग्घ तिमिर जिणिं जग अवहरइ ॥४॥
कुंडलमंडलमंडियगल्ल अरिखंडणभुयदंडपयंड ।
घणथणघोलिरनिम्मलहार पउमावइ नंदउ जगि सार ॥५॥
नेउरझुणिबहिरियदिसिचक्क खग्गदंडखंडियरिउचक्क ।
मणिकंचणचंचुइअपउट्ट पउमि होहि भवियह संतुट्ट ॥६॥
मेह्लमुहलियसोणिपपसि अलिकुलकोमलदीहरकेसि ।
जलधरणीदहउत्तमरमणि पउमपवि भू भयगलगमणि ॥७॥
पासंकुसवरपहरणपाणि तंबचूडविसहरवरझाणि ।
पउमपत्तसमवण्णसरीर ! पउमपवि मा मे अवहीर ॥८॥
भत्तिनमंतसुरासुररमणि मणिकिरीडकरंजियचलणि ।
किं भमई नरमित्त वराय आराहइ सुरवर तुह पाय ॥९॥
तालु पै च झंखर ललिय वीयउ ससिदल लहयलकीलउ ।

॥आंचली॥

तुह वीयक्खर जो समरेइ मनवंछितफल सो पामेइ ॥१०॥
 भणइहि जोगी मज्झिम नीय धरि चित्तदक्खर सिरिगुरुरीय ।
 जोडवि ससहर ईसर उड्ढ तव कल जाणइ कोवि वियड्ढ ॥११॥
 भूअंतिल सुवच्छिम सहिय चितवि अंतिम पय परिगहिय ।
 अड्ढवि उड्ढवि विंदु धरेयवि धण्ण झु ज्ञायइ पउमिणि देवि ॥१२॥
 सुण्ण जलण तुरियस्सरजुत्त अमियक्किरणकलगयण पवित्त ।
 गुरुउवपसिइं जवइ जु लक्ख पउमएवि तसु पूरइ पक्ख ॥१३॥
 दांसकालायण पल्लववण्ण मुहा जाणिवि जो कयपुण्ण ।
 एह विज्जाचूडामणि सरइ कम्मलक्क ते लीलइ तरइ ॥१४॥
 संति पुट्टि विहेसण मोह मारण वसि उच्चाडणरोह ।
 एउ वि झत्तिय लोयपयास कवण कवण न हु पूरइ आस ॥१५॥
 पढम पणव माया सम्भारि नमणउ अंतिए वण्ण वियारि ।
 जो समरइ अणुदिण वरभावि सव्वसिद्धि तसु परिणइ आवि ॥१६॥
 भूयपेयडाइणिगण डरइ सयलह दुज्जण मण परहरइ ।
 एह विज्जु समरंतइ लोइं भम्मदा य पुहवी सिर होइ ॥१७॥
 विज्जा एसा लोक्कपहाण चितामणि कएपद्दुसमाण ।
 एहु जिणदत्तसूरि उवएसि थंभइ परबल अद्धनिवेसिं ॥१८॥
 हंसगमणि नीलुप्पलनयणि कुंददसणि पुण्णिमससिवयणि ।
 बहुखयणी मुणसहरणि नवकिसलयकोमलवरचरणि ॥१९॥
 पीणसिहिणभारोणयअङ्गि हावभावसिंगारसुचंगि ।
 एकक्खरि जे नर समरंति ताहं तियसकामिणि वय हुंति ॥२०॥
 देउ पाप पउमिणि धरणिंदु बारस परजुयहरिकलविंदु ।
 पउम पउमकडिनी नम अन्त सयलकाम तुह पूरइ मन्त ॥२१॥
 जंभ थंभ मोहे धमयंति जय अपराजिय विजय जयन्ती ।
 चण्डी भइरव तोतल ताल सहइ इक्कच्चिय विविहपयार ॥२२॥
 खित्तवाल जोइणि चउसट्टि भूयपेयडाइणिगहदिट्टि ।
 अवरवि दुद्धर विग्घ जि केवि नामगहणिं नासइ तुह देवि ! ॥२३॥
 जे धण्णंतरि विज्ज अस्सज्ज ते उवादि एहु सामि सुसज्ज ।
 नीर जलण थंभइ तुह आण समरंगिणि वारइ अरिवाण ॥२४॥
 पइसट्टी जंति च्चिइ भुवणि भइवइ सम्मतु लंभिय सव्वणि ।
 कंपइ धरणीयल धणई लडफडंति दस दिसि माइ ॥२५॥

कुलपव्वय सत्तवि टलटलइ अनु सत्तवि जलनिहि उच्छलइ ।
 किडि किडित उक्कड किडि दाढ भज्जइ फणिवइ फण अइगाढ ॥२६॥
 दढ गढ गिरिवर खडहडि पडइ सुरनर जीविय संसइं चडइ ।
 हल्लोहल्लिइं जलहरपूर घुम्मइ तारायण ससिसूर ॥२७॥
 पइं तुट्ठिं जापिच्चरइ भूयणि पउमिणि समरइ तनी सवणि ।
 भक्खइ भुजु अट्टारसमेउ भुंजिज्जइ पिज्जइ वरपेउ ॥२८॥
 पहिरिज्जइ कप्पडे वरसार कंचण कुंडल मोतीहार ।
 सम्माणिज्जइ वर तंबोल सम्मइ वंदीयण हलबोल ॥२९॥
 चंदणमयणाहिघुसिणघणसार किज्जइ सुरहि विलेवणसार ।
 घरि बज्जइ तुरियहं थट्ठि दीसइ मयभंभलदोघट्ठि ॥३०॥
 रहवरकरिजंगमसुर जाण उलग्गइ...इक्कपहाण ।
 अणुसलिसइं चामरक्त भाणिज्जइ माणिणि अणुरत्त ॥३१॥
 ससहरकल बारससरजुत्त थावरजंगमविसहरत्त ।
 हंसहारहरससहरकंति नाम गहणिं तुह दयफल हुंति ॥३२॥
 वंझनारि तुह पय ज्ञायंति सुरकुमरोवम पुत्त लहंति ।
 निंदू नंदण जणइ चिराउ दूहव पावइ वल्लह राउ ॥३३॥
 चिंतियफल चिंतामणि मंति तुज्झ पसारिं फलइ नियंतु ।
 तुल्ल अणुग्गह नर पिक्खेवि सिज्जइ सोलह विज्जापवि ॥३४॥
 रूपकंतिसोहग्गनिहाण निव पूइयपय अमिलियमाण ।
 कविवाइसर हुंति ते धण्ण जाहं पउमि ! तु होहि पसण्ण ॥३५॥
 तुह गुण अंत न केणवि मुणिय तहवि तुज्झ मइं गुणलव थुणिय ।
 आण जु पालइ जिणसिंघ सूरि तार्य संघमणवंछियपूरि ॥३६॥
 पउमावई चउपई पढंत होइ पुरिस तिहुयणसिरिकंत ।
 रम्म भणइ नियजसकप्पूरि सूरदीय भवण जिणप्पहसूरि ॥३७॥



परिशिष्ट ११

अहम् ।

श्रीमल्लिषेणाचार्यविरचितः

सरस्वतीमन्त्रकल्पः

जगदीशं जिनं देवमभिवन्द्याभिशङ्करम् ।
वक्ष्ये सरस्वतीकल्पं समासायाल्पमेधसाम् ॥१॥
अभयज्ञानमुद्राक्षमालापुस्तकधारिणी ।
त्रिनेत्रा पातु मां वाणी जटावालेन्दुमण्डिता ॥२॥
लब्धवाणीप्रसादेन मल्लिषेणेन सूरिणा ।
रच्यते भारतीकल्पः स्वल्पजाप्यफलप्रदः ॥३॥
दक्षो जितेन्द्रियो मौनी देवताराधनोद्यमी ।
निर्भयो निर्मदो मन्त्री शास्त्रेऽस्मिन् स प्रशस्यते ॥४॥
पुलिने निम्नगातीरे पर्वतारामसङ्कुले ।
रम्यैकान्तप्रदेशे वा हर्म्ये कोलाहलोज्ज्वले ॥५॥
तत्र स्थित्वा कृतस्नानः प्रत्यूषे देवतार्चनम् ।
कुर्यात् पर्यङ्कयोगेन सर्वव्यापारवर्जितः ॥६॥
तेजोवदद्रयस्याग्रे लिखेद् वाग्वादिनीपदम् ।
ततश्च पञ्च शून्यानि पञ्चसु स्थानकेष्वपि ॥७॥

ॐ वद वद वाग्वादिनी ह्रीं हृदयाय नमः । ॐ वद वद वाग्वादिनी ह्रीं शिरसे नमः ।
ॐ वद वद वाग्वादिनी हूं शिखायै नमः । ॐ वद वद वाग्वादिनी ह्रीं कवचाय नमः । ॐ
वद वद वाग्वादिनी ह्रः अस्त्राय नमः । इति सकलीकरणं विधातव्यम् ।
रेफैर्ज्वलद्भिरात्मानं दग्धमग्निपुरस्थितम् ।
ध्यायेदमृतमन्त्रेण कृतस्नानस्ततः सुधीः ॥८॥

ॐ अमृते ! अमृतोद्भवे ! अमृतवर्षिणि ! अमृतं श्रावय श्रावय सं सं ह्रीं ह्रीं क्लीं
क्लीं क्लूं क्लूं द्रां द्रां द्रीं द्रीं द्रूं द्रूं द्रावय द्रावय स्वाहा । स्नानमन्त्रः । विनयमहा ।

ॐ ह्रीं पद्मयशसे योगपीठाय नमः । पीठस्थापनमन्त्रः ।

पट्टकेऽष्टदलाम्भोजं श्रीखण्डेन सुगन्धिना ।

जातिकास्वर्णलेखिन्या दूर्वादभेण वा लिखेत् ॥९॥

ॐकारपूर्वाणि नमोऽन्तगानि शरीरविन्यासकृताक्षराणि ।

प्रत्येकतोऽष्टौ च यथाक्रमेण देयानि तान्यष्टसु पत्रकेषु ॥१०॥

ब्रह्महोमनमःशब्दं मध्येकर्णिकमालिखेत् ।

कं कः प्रभृतिभिर्वर्णैर्वेष्टयेत् तन्निरन्तरम् ॥११॥

कं कः, चं चः, टं टः, तं तः, पं पः, यं यः, रं रः, लं लः, वं वः, शं शः, षं षः,
सं सः, हं हः, लं लः, क्षं क्षः, खं खः, छं छः, ठं ठः, थं थः, फं फः, गं गः, जजः,
डं डः, दं दः, बं बः, घं घः, झं झः, ढं ढः, धं धः, भं भः, ङं ङः, ञं ञः,
न नः, मं मः, पतानि केसराक्षराणि ।

बाह्ये त्रिमायया वेष्टय कुम्भकेनाम्बुजोपरि ।

प्रतिष्ठापनमन्त्रेण स्थापयेत् तां सरस्वतीम् ॥१२॥

ॐ अमले ! विमले ! सर्वज्ञे ! विभावरि ! वागीश्वरि ! ज्वलदीधिति ! स्वाहा
प्रतिष्ठापनमन्त्रः ॥

अर्चयेत् परया भक्त्या गन्धपुष्पाक्षतादिभिः ।

विनयादिनमोऽन्तेन मन्त्रेण श्रीसरस्वतीम् ॥१३॥

ॐ सरस्वती नमः ।

विनयं मायाहरिवल्लभाक्षरं तत्पुरो वदद्वितयम् ।

वाग्वादिनी च होमं वागीशा मूलमन्त्रोऽयम् ॥१४॥

ॐ ह्रीं श्रीं वद वद वाग्वादिनी स्वाहा । मूलमन्त्रः ।

यो जपेजातिकापुष्पैर्भानुसङ्घयसहस्रकैः ।

दशांशहोमसंयुक्तं स स्याद् वागीश्वरीसमः ॥१५॥

महिषाक्षगुग्गुलेन प्रतिनिर्मितचणकमानसद्गुटिकाः ।

होमस्त्रिमधुरयुक्तैर्वरदाऽत्र सरस्वती भवति ॥१६॥

देहशिरोदृग्नासासर्वमुखाननसुकण्ठहृन्नाभि ।

पादेषु मूलमन्त्रबीजद्वयवर्जितं ध्यायेत् ॥१७॥

श्वेताम्बरां चतुर्भुजां सरोजविष्टरस्थिताम् ।

सरस्वतीं वरप्रदामहर्निशं नमाम्यहम् ॥१८॥

साङ्ख्यभौतिकचार्वाकमीमांसकदिगम्बराः ।

सौगतास्तेऽपि देवि ! त्वां ध्यायन्ति ज्ञानहेतवे ॥१९॥

भानूदये तिमिरमेति यथा विनाशं
 क्ष्वेडं विनश्यति यथा गरुडागमेन ।
 तद्वत् समस्तदुरितं चिरसञ्चितं मे
 देवि ! त्वदीयमुखदर्पणदर्शनेन ॥२०॥
 गमकत्वं कवित्वं च वाग्मित्वं वादिता तथा ।
 भारति ! त्वत्प्रसादेन जायते भुवने नृणाम् ॥२१॥

सरस्वतीस्तवः ।

जपकाले नमःशब्दं मन्त्रस्यान्ते नियोजयेत् ।
 होमकाले पुनः स्वाहा मन्त्रस्यायं सदा क्रमः ॥२२॥
 सवृन्तकं समादाय प्रसूनं ज्ञानमुद्रया ।
 मन्त्रमुच्चार्य सन्मन्त्री श्वासं मुञ्चीत रेचनात् ॥२३॥
 वाग्भवं कामराजं च सान्तं पान्तेन संयुतम् ।
 विन्द्रोङ्कारयुतं मन्त्रं ग्वे पुरं तन्निगद्यते ॥२४॥
 ऐं क्लीं दू ह्रसौं नमः ।
 श्वेतैः पुष्पैर्भवेद् वाचा शोणितैर्वश्यमोहनम् ।
 लक्षजापेन संसिद्धिं याति मन्त्रं सहोमतः ॥२५॥
 ऐं क्लीं ह्रसौं मन्त्रः ।
 उष्माणामादिमं बीजं ब्रह्मबीजसमन्वितम् ।
 लान्तं रान्तेन संयुक्तं मायावाग्भवबीजकम् ॥२६॥
 स्वर्लां हीं ऐं सरस्वत्यै नमः ।
 मन्त्रं जपति यो नित्यं जातिकाकुसुमैर्वरैः ।
 रविसङ्ख्यसहस्राणि स स्याद् वाचस्पतेः समः ॥२७॥
 सप्त लक्षाणि यो विद्यां मायामेकाक्षरीं जपेत् ।
 तस्य सिद्ध्यति वागीशा पुष्पैरिन्दुसमप्रभैः ॥२८॥
 हीं झं वं ह्यो जलभूबीजैर्नाम यत् तत् स्वरैर्वृतम् ।
 बाह्ये द्विषद्दलाम्भोजपत्रेषु सकलं नमः ॥२९॥
 सान्तं सम्पुटमालिख्य इवीं हंसैर्बलयीकृतम् ।
 अम्भःपुरपुटोपेतं सद्भूर्जे चन्दनादिभिः ॥३०॥
 सिक्थकेन समावेष्ट्य जलपूर्णघटे क्षिपेत् ।
 दाहस्योपशमं कुर्याद् ग्रहपीडां निवारयेत् ॥३१॥
 नाम त्रिमूर्त्तिमध्यस्थं क्लीं क्रौं दिक्षु विदिक्षु च ।

शान्तिकयन्त्रम् ।

बहिर्वन्हिपुटं कोष्ठेष्वै जम्भे ! होममालिखेत् ॥३२॥
 मोहापि च तथा ग्रान्तब्राह्मण्लूकारमास्थितम् ।
 ॐ ब्लै धात्रे वपट् वेष्ट्यान्तर्बाह्ये क्षितिमण्डलम् ॥३३॥
 फलके भूर्यपत्रे वा लिखित्वा कुङ्कुमादिभिः ।
 पूजयेद् यः सदा यन्त्रं सर्वं तस्य वशं जगत् ॥३४॥

वश्ययन्त्रम् ॥

मान्तं नामयुतं द्विरेफसहितं बाह्ये कलावेष्टितं
 तद्बाह्येऽग्निमरुत्परं विलिखितं ताम्बूलपत्रोदरे ।
 लेखिन्यान्यमृताक्षकणकभुवार्कक्षीरराजीप्लुतं
 तप्तं दीपशिखाग्निना त्रिदिवसे रम्भामपीहानयेत् ॥३५॥
 रेफद्वयेन सहितं लिख मान्तयुगं पष्ठस्वरस्वरचतुर्दशविन्दुयुक्तम् ।
 बाह्ये त्रिवह्निपुरमालिख चैतदन्तः पाशत्रिमूर्त्तिगजवश्यकरैश्च वेष्टयम् ॥३६॥
 पुरं हिरण्यरेतसो विलिख्य तद्बहिः पुनः ।
 करोतु मन्त्रवेष्टनं ततोऽग्निवायुमण्डलम् ॥३७॥

तद्यथा—

ॐ आँ ह्रीं क्रौं म्ल्यंग्यं जम्भे ! मोहे ! रररर घे घे सर्वाङ्गं
 दह दह देवदत्ताया हृदयं मम वश्यमानय ह्रीं यं वौषट् ॥
 तं ताम्बूलरसेन हेमगरलग्रह्यादिभिः संयुजा
 प्रेतावासनकर्परैः प्रविलिखेत् ताम्रस्य पत्रेऽथवा ।
 भङ्गारैः खदिरोद्भवैः प्रतिदिनं सन्ध्यासु सन्तापयेत्
 सप्ताहात् वनितां मनोऽभिलपितां मन्त्री हठादानयेत् ॥३८॥
 संलिख्याष्टदलाब्जमध्यगगनं कामाधिपेनावृतं
 तत्पत्रेषु तदक्षरं प्रविलिखेद् पत्राग्रतोऽग्न्यक्षरम् ।
 ब्लै पत्रान्तरपूरितं वलयितं मन्त्रेण वामादिना
 द्रां द्रीं ब्लूं स्मरवीजहोमसहितेनैतज्जगत्क्षोभणम् ॥३९॥
 जाप्यः सहस्रदशकं सुभगायोनावलक्तकं धृत्वा ।
 विद्या नवाक्षरीया तथापसव्येन हस्तेन ॥४०॥

ॐ ह्रीं आँ क्रौं ह्रीं क्षीं ह्रीं क्लीं ब्लूं द्रां द्रीं

ॐ कामिनी रञ्जय होममन्त्रं यस्या लिखेच्चात्मकरेऽपसव्ये ।
 सन्दर्शयेत् सा स्मरवाणभिन्नाऽद्भुतं भवत्यत्र किमस्ति चित्रम् ॥४१॥
 विनयं चले चलचित्ते रतौ मुञ्चयुगं होमम् ।
 द्रावयत्यबलां बलाल्लक्षणेनैकेन जाप्येन ॥४२॥

सिन्दूरसन्निभं पिण्डमैवलक्षरनिर्मितम् ।
 ध्यातं सत्रिन्दुकं योन्यां द्रावयत्यबलां बलात् ॥४३॥
 सम्पिष्टोत्तिकांमूलं जलशौचं स्वरेतसा ।
 भर्तुर्ददाति या पण्डं सान्यां प्रतिकरोति तम् ॥४४॥
 मर्दयेत् पिप्पलाकामं सूतकेन कुरुण्टिका ।
 क्षीरेण मधुना सार्धं लिङ्गलेपोऽबलास्मरः ॥४५॥
 मधुकर्पूरसौभाग्यं पिप्पिलीकामसंयुतम् ।
 द्रावयत्यङ्गनादर्पं लिङ्गलेपनमात्रतः ॥४६॥
 परण्डतेलं फणिकृत्तियुक्तं सन्मातुलिङ्गस्य च बीजमिश्रम् ।
 धूपं च दद्याद्रतिहर्म्यमध्ये स्त्रीमोहनं ज्ञानविदो वदन्ति ॥४७॥
 क्लींकाररुद्धं लिख कूटपिण्डं नामान्वितं द्वादशपत्रपद्मम् ।
 ब्रह्मादिहोमान्तपदेन युक्ताः पूर्वादिपत्रेषु जयादिदेव्यः ॥४८॥

ॐ जये स्वाहा । ॐ विजये स्वाहा । ॐ अजिते स्वाहा । ॐ अपराजिते स्वाहा ।

जभमहपिण्डसमेता जम्भाद्याः प्रणवपूर्वहोमान्ताः ।

विदिगूदलेषु योज्याः स्मरबीजं शेषपत्रेषु ॥४९॥

ॐ ज्म्ल्युं जम्मे ! स्वाहा ! ॐ भ्म्ल्युं मोहे ! स्वाहा ! ॐ म्म्ल्युं स्तम्मे ! स्वाहा ।

ॐ ह्म्ल्युं स्तम्भिनी स्वाहा । शेषपत्रेषु क्लीं ।

त्रिधा मायया वेष्टितं क्लौंनिरुद्धं लिखेद् रोचनाकुङ्कुमैर्भूर्यपत्रे ।

मधुस्थापितं वेष्टितं रक्तसूत्रैर्वशं याति रम्भायि सप्ताहमध्ये ॥५०॥

क्लींरञ्जिका ॥१॥

यन्त्रं तदेव त्रिलिखेद् वनिताकपाले गोरोचनादिभिरनङ्गपदे त्रिमूर्त्तिम् ।

सन्ध्यासु सप्तदिवसं खदिराग्नितप्तां देवाङ्गनामपि समानयनीह नाकात् ॥५१॥

हींरञ्जिका ॥२॥

स्थाने त्रिमूर्तेर्लिख विश्वबीजं कस्तूरिकाद्यैर्वरभूर्जपत्रे ।

बाह्ये वृत्तं रूपपतङ्गवेष्ट्यं सीमन्तिनीनां विदधाति मोहम् ॥५२॥

ईंरञ्जिका । ३

विष्णोः पदे समभियोजय रोषबीजं मानुष्यचर्मणि विषेण सलोहितेन ।

कुण्डे प्रपूर्य खदिरज्वलनेन तप्तं शत्रोरकालमरणं कुरुतेऽविकल्पात् ॥५३॥

हूंरञ्जिका । ४

भूर्जेऽरुणेन सविषेण मकारबीजं हूं स्थानके लिख मलीमलमूत्रवेष्ट्यम् ।

मृत्पात्रिकोदरगतं निहितं श्मशाने दुष्टस्य निग्रहमिदं विदधाति यन्त्रम् ॥५४॥

मः ५

यन्त्रं विभीतफलके विषलोहिताभ्यां

मः स्थानकेऽग्निमरुतोः प्रविलिख्य बीजम्

संवेष्ट्य वाजिमहिषोद्भवकेशपाशैः

प्रेतालयस्थमचिरेण करोति वैरम् ॥५५॥

यः ६

अननपवनबीजे वायुबीजं ससृष्टिं, त्रितिजगरलकाकामध्ययुक्तैर्विलिख्यम् ।

गगनगमनपक्षणोद्यखण्डे ध्वजानां पवनहतमरात्युच्चाटनं तद् विदध्यात् ॥५६॥ यः ७

स्वल्पेन मानुषभुवा नृकपालयुग्मे पूर्वोदिताक्षरपदे विलिखेत् खबीजम् ।

क्ष्वेडारुणेन मृतकालयभस्मपूर्णे प्रोच्चाटयेदरिकुलं निहितं श्मशाने ॥५७॥

इः ८

प्रेताम्बरे व्योमपदे विलेख्यं फडक्षरं निम्बनृपार्कक्षीरैः ।

सिद्धालये तन्निखनेत् क्षपायां बभ्रम्यते काक इवारिरुर्व्याम् ॥५८॥

फट् ९

कूटं फडक्षरपदे लिख कुङ्कुमाद्यैर्भूर्यै वषट्पदयुतं मठितं त्रिलोहैः ।

पुंसां स्वबाहुकटिकेशगले धृतानां सौभाग्यकृद् युवतिभूपतिवश्यकारि ॥५९॥

क्ष वषट् । १०

क्षस्थानकेऽथ लिखितं हरितालकाद्यैरिन्द्रं शिलातलपुटे क्षितिमण्डलस्थम् ।

सूत्रेण तत् परिवृतं विधृतं धरायां कुर्यात् प्रसूतिमुखदिव्यगतेनिरोधम् ॥६०॥

लं ११ रञ्जिका द्वावशयन्त्रोद्धारः ॥

अजपुटे लिखेन्नाम ग्लौं क्षं पूर्णेन्दुवेष्टितम् ।

वज्राष्टकपरिच्छिन्नमग्रान्तब्राह्मणाक्षरम् ॥६१॥

तद्बाह्ये भूपुरं लेख्यं शिलायां तालकादिना ।

कोपादिस्तम्भनं कुर्यात् पीतपुष्पैः सुपूजितम् ॥६२॥

ॐ ग्लौं क्षं ठ लं स्वाहा ।

संलिख्य नामाष्टदलाब्जमध्ये मायावृतं षोडशसत्कलाभिः ।

कलीं बलं तथा द्रामथ योजयित्वा दिक्स्थेषु पत्रेषु सदा क्रमेण ॥६३॥

होमं लिखेद्दङ्कुशबीजमुच्चैः किञ्चान्यपत्रेषु बहिस्त्रिमूर्तिः ।

भूर्जे हिमाद्यैर्विधृतं स्वकण्ठे सौभाग्यवृद्धिं कुरुतेऽङ्गनानाम् ॥६४॥

सौभाग्यरक्षा ।

क्षजभमहरेफपिण्डैः पाशाङ्कुशबाणरञ्जिकायुक्तैः ।

प्रणवाद्यैः कुरु मन्त्रिन् । षट् कर्माण्युदयमवगम्य ॥६५॥

ॐ क्ष्म्ल्युं ज्म्ल्युं भ्म्ल्युं म्म्ल्युं ह्म्ल्युं ड्म्ल्युं आं क्रीं ह्रीं क्लीं क्लूं

द्रीं द्रीं संवौषट् त्रिभुवने सारः । सहस्र १२ जपः । दशांशेन होमः ॥

वश्यविद्वेषणोच्चाटे पूर्वमध्यापराणहके ।
 सन्ध्यार्धरात्ररात्र्यन्ते मारणे शान्तिपौष्टिके ॥६६॥
 वषड् वश्ये फडुच्चाटे हुं द्वेषे पौष्टिकं स्वधा ।
 संवौषडाकर्षणे स्वाहा शान्तिकेऽव्यथ मारणे ॥६७॥
 पीतारुणासितैः पुष्पैः स्तम्भनाकृष्टिमारणे ।
 शान्तिपौष्टिकयोः श्वेतैर्जपेन्मन्त्रं प्रयत्नतः ॥६८॥
 कुर्याद् हस्तेन वामेन वश्याकर्षणमोहनम् ।
 शेषकर्माणि होमं च दक्षिणेन विचक्षणः ॥६९॥
 उदधीन्द्रमारुतान्तकनैर्ऋतकुबेरदिक्षु कृतवदनः ।
 शान्तिकरोधोच्चाटनमारणसम्पुष्टिजनवश्ये ॥७०॥
 शान्तिपुष्टौ भवेद्धोमो दूर्वाश्रीखण्डतण्डुलैः ।
 महिषाक्षरङ्गाम्भोजैः पुरश्चोभो निगद्यते ॥७१॥
 करवीरारुणैः पुष्पैरङ्गनाक्षोभमुत्तमम् ।
 होमैः क्रमुकपत्राणां राजवश्यं विधीयते ॥७२॥
 गृहधूमनिम्बपत्रैर्द्विजपक्षैर्लवणराजिकायुक्तैः ।
 हुतैस्त्रिसन्ध्यविहितैर्विद्वेषो भवति मनुजानाम् ॥७३॥
 प्रेतालयास्थिखण्डैर्विभीतकाङ्गारसमधूमयुतैः ।
 सप्ताहविहितहोमैररातिमरणं बुधैर्दिष्टम् ॥७४॥
 नैवेद्यदीपादिभिरिन्द्रसङ्घैः सुवर्णपादावभिपूज्य देव्याः ।
 स्ववामदेशस्थितसव्यहस्तो मन्त्री प्रदद्यात् सहिरण्यमम्भः ॥७५॥
 विद्या मयेयं भवते प्रदत्ता त्वया न देयान्यदृशे जनाय ।
 तच् श्रावयित्वा गुरुदेवतानामग्रेषु विद्या विधिना प्रदेया ॥७६॥

आज्ञाक्रमः

कृतिना मल्लिषेणेन जिनसेनस्य सुनुना ।
 रचितो भारतीकल्पः शिष्टलोकमनोहरः ॥७७॥
 सूर्याचन्द्रमसौ यावन्मेदिनीभूधरार्णवाः ।
 तावत् सरस्वतीकल्पः स्थेयाच्चेतसि धीमताम् ॥७८॥

श्रीमल्लिषेणसारस्वतविधिरयम्—

प्रथमः कृतस्नानः समौनः प्रातः श्रीभारत्याः पूजां कृत्वा विहितार्कक्षारोदनः ततो-
 ऽनन्तरं सन्ध्यासमये पुनः स्नात्वा सर्वव्यापारवर्जितो भूत्वा शुचिः श्वेतं वस्तु ध्यायेत् ।

ॐ ह भूरिसी भूतधात्री भूमिशुद्धि कुरु कुरु स्वाहा ।

भूमिशुद्धिमन्त्रः ।

ॐ ह्रीं वां नमो अरिहंताणं अशुचिः शुचीभवामि स्वाहा ।

आत्मशुद्धिमन्त्रः ॥

ॐ ह्रीं वद् वद् वाग्वादिनी ह्रीं हृदयाय नमः । ह्रीं शिरसे नमः ।
ह्रूं शिखायै नमः । ह्रौं कवचाय नमः । ह्रः अस्त्राय नमः ।

इति सकलीकरणं विधातव्यम् ।

ततोऽमृतमन्त्रेण सरस्वत्याः पूजा क्रियते ।

ॐ अमृते ! अमृतोद्भवे ! अमृतवर्षिणि ! अमृतवाहिनि ! अमृतं श्रावय श्रावय
ॐ ऐं क्लीं क्लीं ब्लूं [ब्लूं] द्रां द्रीं द्रावय द्रावय स्वाहा ।

अथ मण्डलस्थापना विधीयते—

ॐ ह्रीं महापद्मयशसे योगपीठाय नमः

पीठस्थापनमन्त्रः ॥

ॐ ह्रीं अमले ! विमले ! सर्वज्ञे ! विभावरि ! वागीश्वरि ! कलम्बपुष्पिणि स्वाहा ।

प्रतिष्ठामन्त्रः

ततो मण्डलपूजा विधीयते । ॐ सरस्वत्यै नमः । पूजामन्त्रः ।

मण्डलाग्रेऽग्निकुण्डं समचतुरस्रं विधीयते अङ्गुल १६ प्रमाणम् । ततो मूलमन्त्रेण
जाप १२००० । ततो दशांशेन होमः । गुग्गुल-मधु-घृत-पुष्पसहितगुटिका चनकप्र-
माणा १२००० होमः पिप्पलपलाशशमिसमिधैः । मूलमन्त्रेण करजापलक्ष १००००० ।
ततः सिद्धिः ।

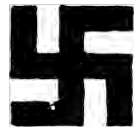

परिशिष्ट १२
श्रीबप्पभट्टिसूरिकृतं
श्रीसरस्वतीकल्पः ।

कन्दात् कुण्डलिनी ! त्वदीयवपुषो निर्गत्य तन्तुत्विषा
किञ्चिच्चुम्बितमम्बुजं शतदलं त्वद्ब्रह्मरन्धादयः ।
यश्चन्द्रद्युति ! चिन्तयत्यविरतं भूयोऽस्य भूमण्डले
तन्मन्ये कविचक्रवर्तिपदवी छत्रच्छलाद् वल्गति ॥१॥
यस्त्वद्वक्त्रमृगाङ्गमण्डलमिलत्कान्तिप्रतानोच्छल-
च्चञ्चन्द्रकचक्रचित्रितककुप्कन्याकुल ! ध्यायति ।
वाणि ! वाणिविलासभङ्गुरपदप्रागल्भ्यशृङ्गारिणी
नृत्यत्युन्मदनर्तकीव सरसं तद्वक्त्ररङ्गाङ्गणे ॥२॥
देवि ! त्वद्धृतचन्द्रकान्तकरकश्चयोतत्सुधानिर्झर-
स्नानानन्दतरङ्गितं पिबति यः पीयूषधाराधरम् ।
तारालंकृतचन्द्रशक्तिकुहरेणाकण्ठमुत्कण्ठितो
वक्त्रेगोद्विरतीव तं पुनरसौ वाणीविलासच्छलान् ॥३॥
धुभ्यत्क्षीरसमुद्रनिर्गतमहाशोषाहिलोलत्फणा-
पत्रोन्निद्रसितारविन्दकुहरैश्चन्द्रस्फुरत्कणिकैः ।
देवि ! त्वां च निजं च पश्यति वपुर्थः कान्तिभिन्नान्तरं
ब्राह्मि ! ब्रह्मपदस्य वल्गति वचः प्रागल्भदुग्धाम्बुधेः ॥४॥
नाभीपाण्डुरपुण्डरीककुहराद् हृत्पुण्डरीके गलत्-
पीयूषद्रववर्षिणि ! प्रविशतीं त्वां मातृकामालिनीम् ।
दृष्ट्वा भारति ! भारती प्रभवति प्रायेण पुंसो यथा
निर्गन्धीनि शतान्यपि ग्रथयति ग्रन्थायुतानां नरः ॥५॥

त्वां मुक्तामयसर्वभूषणगणां शुक्लाम्बराडम्बरां
 गौरीं गौरिसुधातरङ्गधवलामालोक्य हृत्पङ्कजे ।
 वीणापुस्तकमौक्तिकाक्षवलयश्वेताब्जवलाकरां
 न स्यात् कः स्फुटवृत्तचक्ररचनाचातुर्यचिन्तामणिः ॥६॥
 पश्येत् स्वां तनुमिन्दुमण्डलगतां त्वां चाभितो मण्डितां
 यो ब्रह्माण्डकरण्डपिण्डितसुधाडिण्डीरपिण्डैरिव ।
 स्वच्छन्दोद्गतगद्यपद्यलहरीलीलाविलासामृतैः
 सानन्दास्तमुपाचरन्ति कवयश्चन्द्रं चकोरा इव ॥७॥
 तद्वेदान्तशिरस्तदोङ्कृतिमुखं तत् तत्कलालोचनं
 तत्तद्वेदभुजं तदात्महृदयं तद्गद्यपद्याङ्घ्रिं च ।
 यस्त्वद्वर्ष्म विभावयत्यविरतं वाग्देवते ! वाङ्मयं
 शब्दब्रह्मणि निष्ठितः स परमब्रह्मैकतामश्नुते ॥८॥
 वाग्बीजं स्मरबीजवेष्टितमतो ज्योतिःकला तद्बहि-
 श्राष्टद्वादशषोडशद्विगुणितद्व्यष्टाब्जपत्रान्वितम् ।
 तद्बीजाक्षरकादिवर्णरचितान्यत्रे दलस्यान्तरे
 हंसः कूटयुतं भेदेदवितथं यन्त्रं तु सारस्वतम् ॥९॥
 ओमै श्रीमनु सौ ततोऽपि च पुनः क्लीं षडौ वागूवादि-
 न्येतस्मादपि ह्रीं ततोऽपि च सरस्वत्यै नमोऽदः पदम् ।
 अश्रान्तं निजभक्तिशक्तिवशतो यो ध्यायति प्रस्फुटं
 बुद्धिज्ञानविचारसारसहितः स्याद् देव्यसौ साम्प्रतम् ॥१०॥
 स्मृत्वा मन्त्रं सहस्रच्छदकमलमनुध्याय नाभीहृदोत्थं
 श्वेतस्निग्धोर्ध्वनालं हृदि च विक्रचतां प्राप्य निर्यातमास्यात् ।
 तन्मध्ये चोर्ध्वरूपामभयदवरदां पुस्तकाम्भोजपाणिं
 वाग्देवीं त्वन्मुखाच्च स्वमुखमनुगतां चिन्तयेदक्षरालीम् ॥११॥
 किमिह बहुविकल्पैर्जल्पितैर्यस्य कण्ठे
 भवति विमलवृत्तस्थूलमुक्तावलीयम् ।
 भवति भवति ! भाषे ! भव्यभाषाविशेषै-
 र्मधुरमधुसमृद्धस्तस्य वाचां विलासः ॥१२॥

अथ मन्त्रक्रमो लिख्यते—ॐ सरस्वत्यै नमः । अर्चनमन्त्रः ।

ॐ भूरिसी भूतधात्री भूमिशुद्धिं कुरु कुरु स्वाहा । भूमिशुद्धिमन्त्रः । ॐ विम-
ले ! विमलजले ! सर्वतीर्थजले ! पां वां इवां इवीं अशुचिः शुचीभवामि स्वाहा ।
आत्मशुद्धिमन्त्रः ।

ॐ वद वद वाग्वादिनी ह्रीं शिरसे नमः ।

ॐ महापद्मयशसे ह्रीं योगपीठाय नमः ।

ॐ वद वद वाग्वादिनी ह्रूं शिखायै वषट् ।

ॐ वद वद वाग्वादिनी नेत्रद्वयाय वषट् ।

ॐ वद वद वाग्वादिनी कवचाय हुं ।

ॐ वद वद वाग्वादिनि ! अस्त्राय फट् ।

इति सकलीकरणम् ।

ॐ अमृते ! अमृतोद्भवे ! अमृतं स्नावय स्नावय ऐं क्लीं ब्लूं द्रां द्रीं द्रावय
द्रावय स्वाहा ।

यो जपेज्जातिकापुष्पैर्भानुसंख्यसहस्रकम् ।

दशांशहोमसंयुक्तं स स्याद् वागीश्वरीसमः ॥१॥

महिषाख्यगुग्गुलेन प्रविनिर्मितचक्रमात्रसद्गुटिकाः ।

होमस्त्रिमधुरयुक्तः तुष्टा देवी वरं दत्ते ॥२॥

इति शुद्धं श्रीसारस्वतम् ।

अथैतत्पीठक्रमो लिख्यते—

पद्मोपरि पद्मासनस्था भगवतीमूर्तिः करचतुष्टयधृतवरपद्मा शिरसि षट्कोणा-
कारमुकुटभ्राजिता नाभौ चतुर्दलपद्मधारिणी लेख्या । ततो नाभिपद्मे कर्णिकायां ॐ
कारं लिखेत्, पूर्वादिचतुर्दलेषु न १ मः २ सि ३ जं ४ इत्यक्षराणि लेख्यानि । अ-
धस्तनदक्षिणकरे षोडशदलं पद्मं कृत्वा तत्र कर्णिकायां ऐंकारं दत्त्वा पूर्वादिषोडशदलेषु
क्रमेण षोडश स्वरान् लिखेत्, अधस्तनवामकरे पञ्चविंशतिदलं पद्मं कृत्वा तत्कर्णिका-
यां श्रींकारं विलिख्य पूर्वादिपञ्चविंशतिदलेषु क्रमेण क्रमात् कादयो वर्गवर्णाः पञ्चविं-
शतिलेख्याः । अथवोपरितनदक्षिणकरे अष्टदलं पद्मं कृत्वा तत्र कर्णिकायां सौं इति बीजं
लिखित्वा पूर्वादिदलेषु य-र-ल-व-श-ष-स-ह इत्यष्टौ वर्णां लेख्याः । उपरितनवामकरे-
ऽप्यष्टदलं पद्मं कृत्वा तत्कर्णिकायां क्लीं इति बीजं दत्त्वा पूर्वाद्यष्टदलेषु व १ द २ व ३
द ४ वा ५ ग्वा ६ दि ७ नि ८ इति वर्णां लेख्याः । शिरःषट्कोणे गर्भे ह्रींकारं लिखि-
त्वा पूर्वादिकोणषट्के स १ र २ स्व ३ त्यै ४ न ५ मः ६ पवमक्षरषट्कं लेख्यम् । सर्वं
शुक्लध्यानेन षट्चक्रस्थापनं विधाय ध्येयम् ।

मूलमन्त्रश्रायम्-ॐ ऐं श्रीं सौं क्लीं वद वद वाग्वादिनी ह्रीं सरस्वत्यै नमः । इति पाठशुद्धया मन्त्रं स्मरेत्, करजापो लक्षं जातिपुण्यैः सहस्राः १२ जापः । गुग्गुलुगुटी १२०० त्रिमधुरमिश्राः कृत्वा होमः कार्यः, आश्विने चैत्रे वा नवरात्रेषु कार्यं दीपोत्सवामावास्यायां वा ततः सिद्धिः ॥

आम्नायान्तरेण यन्त्रं लिख्यते, यथा-

वृत्तं मण्डलं कृत्वा परितः पूर्वादौ चत्वारि दलानि, तत्र पूर्वदले ॐ ह्रीं देवतायै नमः १, दक्षिणदले ॐ ह्रीं सरस्वत्यै नमः २, पश्चिमदले ॐ ह्रीं भारत्यै नमः ३, उत्तरदले ॐ ह्रीं कुम्भदेवतायै नमः ४,

तद्बहिरष्टदले, तत्र पूर्वदितः ॐ मोहे यः १, ॐ नन्दे यः २, ॐ भद्रे यः ३, ॐ जये यः ४, ॐ विजये यः ५, ॐ अपराजिते यः ६, ॐ जम्मे यः ७, ॐ स्तम्मे यः ८, इति लेख्यम् । तद्बहिः षोडशदलानि, तत्र-ॐ रोहिण्यै नमः १, ॐ प्रज्ञप्त्यै नमः २, इत्यादिषोडश देवीनामानि लेख्यानि, तद्बहिः पुनरष्टदलानि, पूर्वदले ॐ ह्रीं इन्द्राय नमः १ क्रमेण ॐ ह्रीं अग्नये नमः २, ॐ ह्रीं यमाय नमः ३, ॐ ह्रीं नैर्ऋतये नमः ४, ॐ ह्रीं वरुणाय नमः ५, ॐ ह्रीं वायवे नमः ६, ॐ ह्रीं कुबेराय नमः ७, ॐ ह्रीं ईशानाय नमः ८ इति लिखेत् । ततो मायया त्रिरभिवेष्ट्य क्रेङ्कारेण निरुध्य परितः पृथ्वीमण्डलं कोणेषु प्रत्येकं चतुर्वज्राङ्कितं कृत्वा मध्यकोणेषु लं प्रत्येकं लिखेत् ।

इति यन्त्रविधिः ।

यन्त्रमध्ये मन्त्रो भगवतीमूर्तिर्वा लेख्या ।

मन्त्रश्रायम्- ॐ ऐं ह्रीं श्रीं वद वद वाग्वादिनि ! भगवति ! सरस्वति ! ह्रीं नमः । एतन्मन्त्रस्य पूर्वसेवा करजप्यः लक्षं जातीपुष्पजातिश्च १२००० ततो दशांश-होमो घृतगुग्गुलमधुखण्डैर्जपितपुष्पमध्यात् १२००० पुष्पाणि गृहीत्वा गुटिका संचूर्ण्यते । मन्त्रदानं दीपोत्सव एव गर्भे मन्त्रो मूर्तिर्वा भगवत्या लिख्यते यन्त्रस्योभयथापि कार्यम् । जापे नमः । होमे स्वाहा ।

इति श्रीबप्पभट्टिसूरेराम्नायः ।

अथ पुनः श्रीबप्पभट्टिसूरिविद्याक्रमे महापीठोद्धारो लिख्यते-ऐं क्लीं ह्रौंः पूर्ववक्त्राय नमः, १ ऐं क्लीं ह्रौंः दक्षिणवक्त्राय नमः २, ऐं क्लीं ह्रौंः पश्चिमवक्त्राय नमः ३, ऐं क्लीं ह्रौंः उत्तरवक्त्राय नमः ४, ऐं क्लीं ह्रौंः ऊर्ध्ववक्त्राय नमः ५—

वक्त्रपञ्चकम् ।

ऐं हृदि कमलायै हृदयाय नमः १, ऐं शिरः कुलायै नमः, ऐं शिरसे स्वाहा २, ऐं शिखकुलायै शिखायै वौषट् ३, ऐं कवचकुलाय कवचाय नमः ४, ऐं नेत्रायै नेत्र-

त्रयाय वषट् ५, स्राकुलयै अस्त्राय फट् ६, अ पै अङ्गसकलीकरणम् । इति करन्यासः, अङ्गन्यासः, पात्रपूजा, आत्मपूजा, मण्डलपूजा, ततः आह्वानं स्थापनम् ।

सन्निधानं सन्निरोधमुद्रा-दर्शनयोनिमुद्रा-गोस्तनमुद्रा-महामुद्रा इति मुद्रात्रयं दर्शयेत्, ततो जापः कार्यः । यथाशक्त्या करजापेन लक्षजापः । पुष्पजापे चतुर्विंशतिसहस्राणि दशांशेन होमः । पूजापुष्पाणि कुट्टयित्वा गुटिका घृतेन घोलयित्वा होमयेत्, त्रिकोणकुण्डे हस्तमात्रविस्तारे खाते च ततः सिद्धयति ।

ॐ क्लीं ह्रौं वद वद वाग्वादिनि ! ह्रीं नमः । मूलमन्त्रः ॥

वाग्भवं प्रथमं बीजं द्वितीयं कुसुमायुधम् ।

तृतीयं जीवसंज्ञं तु सिद्धसारस्वतं पुनः ॥

वाग्बीजं स्मरबीजवेष्टितमतो ज्योतिःकला तद्बहि-

रष्टद्वादशषोडशद्विगुणितं द्वयष्टाब्जपत्रान्वितम् ।

तद्बीजाक्षरकादिवर्णराचितान्यत्रे दलस्यान्तरे

हंसः कूटयुतं भवेदवितथं यन्त्रं तु सारस्वतम् ॥

स्मृत्वा मन्त्रं सहस्रच्छदकमलमनुध्याय नाभीहृदोत्थं

चेतः स्निग्धोदनालं हृदि च विकचतां प्राप्य निर्यातमास्यात् ।

तन्मध्ये चोर्ध्वरूपामभयदवरदापुस्तिकाम्भोजपाणिं

वाग्देवीं त्वन्मुखाच्च स्वमुखमनुगतां चिन्तयेदक्षरालीम् ॥

ततो मध्ये साध्यनाम ततोऽष्टदलेषु अष्टौ पिठाक्षराणि ऋल्यूर्

चल्यूर् तल्यूर् टल्यूर् षल्यूर् यल्यूर् शल्यूर् ह्रल्यूर् इति

ततो द्वादशदलाक्षराणि यथा कं कः, चं चः, टं टः, तं तः, पं पः, यं यः, रं रः, लं लः, वं वः, शं शः, षं षः, सं सः इति ।

ह्रस्वास्तु भैरवाः प्रोक्ता दीर्घस्वरेण मातरः ।

असिताङ्गो हरुश्चण्डः क्रीध अष्टौ हि भैरवाः ॥

ब्रह्माणी माहेश्वरी कौमारी वाराही वैष्णवी चामुण्डा चण्डिका महालक्ष्मीः इत्यष्टौ मातरः । एवं षोडशदलेषु बीजाक्षराणि यथा-अह्रौं आह्रौं इह्रौं ईह्रौं जह्रौं ऊह्रौं ऋह्रौं ॠह्रौं ल्ह्रौं लृह्रौं प्ह्रौं बेह्रौं ओह्रौं औह्रौं अंह्रौं भःह्रौं । ततोऽपि द्विकाधिकत्रिंशद्दलानि-कह्रौं खह्रौं गह्रौं घह्रौं ङह्रौं चह्रौं छह्रौं जह्रौं झह्रौं ञह्रौं टह्रौं ठह्रौं डह्रौं ढह्रौं णह्रौं तह्रौं थह्रौं दह्रौं धह्रौं नह्रौं प्ह्रौं फह्रौं बह्रौं भह्रौं मह्रौं यह्रौं रह्रौं ल्ह्रौं वह्रौं शह्रौं षह्रौं सह्रौं ३२

प्रत्यन्तरे तु अस्मिन् द्वात्रिंशद्दलकोष्ठेषु ककारादिवर्णानामत्रे बीजाक्षरलेखने पाठान्तरं दृश्यते तदपि लिख्यते । यथा—

कद्रयैः खद्रयैः गद्रयैः घद्रयैः ङद्रयैः चद्रयैः छद्रयैः जद्रयैः झद्रयैः ञद्रयैः टद्रयैः
ठद्रयैः डद्रयैः ढद्रयैः णद्रयैः तद्रयैः थद्रयैः दद्रयैः धद्रयैः नद्रयैः पद्रयैः फद्रयैः
बद्रयैः भद्रयैः मद्रयैः यद्रयैः रद्रयैः लद्रयैः वद्रयैः शद्रयैः षद्रयैः सद्रयैः ३२
इति प्रत्यन्तरपाठान्तरक्रमः ।

ततश्चतुःषष्टिदलानि आलाई ईवाई ऊशाई ऋपाई लृसाई ऐहाई औळाई अंशाई १ ।

आवाई ईशाई ऊपाई ऋसाई लृहाई ऐळाई औशाई अंलाई २ आशाई ईषाई ऊसाई
ऋहाई लृळाई ऐशाई औलाई अंवाई ३

आपाई ईसाई ऊहाई ऋळाई लृक्षाई ऐलाई औवाई अंशाई ४

आसाई ईहाई ऊळाई ऋक्षाई ललाई ऐवाई औशाई अंषाई ५

आहाई ईळाई ऊशाई ऋलाई लृवाई ऐशाई औपाई अंसाई ६

आळाई ईक्षाई ऊलाई ऋवाई लृशाई ऐषाई औसाई अंहाई ७

आशाई ईलाई ऊवाई ऋशाई लृपाई ऐसाई औहाई अंळाई ८

एवं षष्टिः खीलनानि हलेषु ततोऽष्ट दलानि । दलेषु ऐं ३ दुर्गे ! दुर्गदर्शने नमः ।

ऐं ३ चामुण्डे ! चण्डरूपधारिण्यै नमः ।

ऐं ३ जम्भे नमः । ऐं ३ मोहे नमः । ऐं ३ स्तम्भने नमः । ऐं ३ आशापुरायै नमः ।

ऐं ३ विद्युज्जिह्वे ! नमः । ऐं ३ कुण्डलिनी नमः ।

ऐं ह्रींकारवेष्टितं क्रौंकारनिरुद्धं भूरिसी भूतधात्री भूमिशुद्धिं कुरु कुरु स्वाहा ।

भूमिशुद्धिमन्त्रः ।

ऐं विमले ! विमलजलाय सर्वोदकैः स्नानं कुरु कुरु स्वाहा ।

स्नानमन्त्रः ।

मंतपयारो एसो हयारपुव्वि त्ति सोयमग्गम्मि ।

सो च्चिय सयारपुव्वो विज्जानेओ कुले हाइ ॥

.....जीवं दक्षिणवाचयोगसमन्वितम् ।

सिद्धसारस्वतं बीजं सद्यो वै वचःकारः ॥

शुचिप्रदेशे पटे पट्टे वा श्रीखण्डेन कर्पूरेण वा देव्या मूर्तिं कमलासनस्थां देवीचर-
णसमीपे योजितकरां स्वमूर्तिं च आलिख्य देवीप्रतिमां चाग्रतो विन्यस्य देवीपूजापूर्वकं
यथाशक्ति श्रीखण्डजातीकुसुमसुगन्धधूपफलनैवेद्यजलप्रदीपाक्षतादिभिः साधकः पूजयेत् ।
स च स्नानकं च स्नानं वा कृत्वा शुचिवेषः समुपविशेत् । ततश्च 'ॐ विमलाय
विमलचित्ताय पां वां क्षां ह्रीं स्वाहा' अनेन मन्त्रेण वार ३ शिरः प्रदेशात् चरणौ यावत्
हस्ताभ्यां मन्त्रस्नानं कुर्यात् चन्द्रकिरणैर्दुग्धकर्पूरैर्वा आत्मानमभिषिच्यमानं चिन्तयेत् ।

‘ॐ भूरिसि ! भूतधात्री भूमिशुद्धिं कुरु कुरु हुं फन् स्वाहा’ अनेन मन्त्रेण वार ३ भूमिशुद्धिं कुर्यात् । ततः—“ॐ ४ एहि एहि वार ४” अनेन मन्त्रेण आह्वानं कुर्यात् । द्रव्यतो भावतश्च देव्याह्वाननं स्थापना च कार्या । ततः क्षि पञ्चासने, प नाभिप्रदेशे, ॐ हृदये, स्वा नासिकायाम्, हा शिरःप्रदेशे एभिर्मन्त्रपदैरारोहक्रमेण ततश्च हा ५ ललाटे, स्वा ८ नासिकायाम्, ॐ ८ हृदये, प १३ नाभौ, क्षि ५ पञ्चासने एभिरेव मन्त्राक्षरैरात्मगक्षां कुर्यात्, चतुर्दिशं नखच्छोटिकां च शिखाबन्धं विदध्यात् । गुरुपदिप्रधानपूर्वकं मूलमन्त्रं जपेत् । मूलमन्त्रस्य सहस्र १२ करजापे ततःपुष्पजापे सहस्र पुष्पजापसत्कानि पुष्पाणि छायाशुष्काणि सञ्चूर्ण्य गुग्गुलेन सह चणकप्रमाणा गुटिकाः कृत्वा दुग्धघृतखण्डमध्यादाकृष्य ध्यानपूर्वं मन्त्रपूर्वं च होमयेत् खदिराङ्गारैः पलाशसमिद्धिश्च वैश्वानरः प्रथमं ज्वलन् कार्यः । पूजानन्तरम्—ॐ यः विसर्जनमन्त्रः लक्षजापे दिननियमो नास्ति, तत्रापि पूर्वविधिना दशांशेन होमः कार्यः, करजापे लक्ष १, पुष्पजापे लक्ष १, होमसहस्र १० उत्तरक्रियायां करजाप लक्ष १ सिद्धिं यावत् साधकः साधयेत् । ब्रह्मचर्यं भूमिशयनं वृक्षशयनं वा । एकवारभोजनं आम्ललवणवर्जं च कुर्यात् । स्वप्नेऽपि वीर्यच्युतौ मूलतो गच्छति, अतोऽनवरतं पलचीप्रभृतिवीर्यापहारकं भक्षयेत् ।

होमकुण्डं अङ्गुल १६, विस्तारे अङ्गुल १२॥

अ ॐ स्वाहा कुण्डस्य स्थापना ! आ ॐ स्वाहा मृत्तिकासंस्कारः ।

इ ॐ स्वाहा जलसंस्कारः । ई ॐ स्वाहा गोमयसंस्कारः ।

उ ॐ स्वाहा उभयसंयोगसंस्कारः । ऊ ॐ लिम्पनसंस्कारः

ऋ ॐ स्वाहा दहनसंस्कारः । ॠ ॐ शोषणसंस्कारः ।

ऌ ॐ स्वाहा अमृतलावणसंस्कारः । ॡ ॐ स्वाहा मन्त्र पूतसंस्कारः ।

ए ॐ इन्द्रासनाय नमः । ऐ ॐ स्वाहा अनलदेवतासनाय नमः ।

ओ ॐ यमाय स्वाहा । औ ॐ नैर्ऋताय स्वाहा ।

अं ॐ वरुणाय स्वाहा । अँ ॐ वायवे स्वाहा ।

अं अः ॐ धनदाय स्वाहा । अँ अः ॐ ईशानाय स्वाहा ।

लं ॐ कुण्डदेवतायै स्वाहा । क्षं ॐ स्वाहा एवं कुण्डसंस्कारः ।

ॐ जातवेदा आगच्छ आगच्छ सर्वाणि कार्याणि साधय साधय साधय स्वाहा ।

आह्वाननम् ।

र ॐ जलेन प्रोक्षणम् । र ॐ अभ्रोक्षणम् ।

र ॐ त्रिर्मार्जनम् । र ॐ सर्वभस्मीकरणम् ।

र ॐ क्रव्यादजिह्वां परिहरामि । दक्षिणदिशि पुष्पं भ्रामयित्वा क्षेपणीयम् ।
अथ वैश्वानररक्षा—

ॐ हृदयाय नमः, ॐ शिरसे स्वाहा, । वैश्वानररक्षा ।

जिह्वा-चतुर्भुज-त्रिनेत्र-पिङ्गलकेश-रक्तवर्ण-तस्य नाभिकमले मन्त्रो न्यसनीयः ।
होतव्यं द्रव्यं ततस्मै उपतिष्ठते ।

वैश्वानराहूतिः ॐ जातवेदा सतजिह्व ! सकलदेवमुख ! स्वधा । वार २१ आहूतिः
करणीया । यत्स्युं बहुरूपाजिह्वे ! स्वाहा होमात् पूर्णाहूतिः मूलमन्त्रेण ” देव्यै साङ्गायै
सपरिकरायै समस्तवाङ्मयसिद्धये द्वादशशतानि जापपुष्पचूर्णगुग्गुलुगुटिका पूर्णाहूतिः ।
स्वाहा अनेन क्रमेण वार ३ यावद् भण्यते तावद्नवच्छिन्नं आज्यधारया नागवल्लीपत्र-
मुखेन पूर्णाहूतिः कार्या । घृतकर्षः ताम्बूलं नैवेद्यम्, यज्ञोपवीत-नवीनश्वेतवस्त्रखण्डं
वा दधिदूर्वाक्षतादिभिराहूतिः करणीया ।

अथ विसर्जनम्—

मूलमन्त्रेण साङ्गायै सपरिवारायै देव्यै सरस्वत्यै नमः—अनेन मन्त्रेण आत्महृदयाय
स्वाहा । वैश्वानरनाभिकमलात् देवी ध्यानेनात्मनि संस्करणीया पश्चाद् ॐ अस्त्राय फट्
इति मन्त्रं वारचतुष्टयं भणित्वा वार ४ अग्निविसर्जनं कार्यम् ।

ॐ क्षमस्व क्षमस्व भस्मना तिलकं कार्यम् ।

ॐ ह्रीं श्रीं क्लीं ह्रौं वद वद वाग्वादिनि ! भगवति सरस्वति ! तुभ्यं नमः ।

इति सारस्वतं समाप्तम् ।

अत्र श्रीवृष्णभट्टिसारस्वतकल्पोक्तमाद्यं बृहद् यन्त्रम्?, इदं च द्वितीयमपि यन्त्रं आम्ना-
यान्तरे दन्द्यते । गुरुक्रमेण लब्ध्वा पूजनीयम् । सर्वं तत्त्वमिदं पाठतस्तु

वाग्बीजं स्मरबीजवेष्टितमतो ज्योतिः कला तद्बहि-

श्चाष्टद्वादशबोडशद्विगुणितं छष्टाब्जपत्रान्वितम् ।

तद्बीजाक्षरकादिवर्णरचितान्यग्रे दलस्यान्तरे

हंसः कूटयुतं भवेदवितथं यन्त्रं तु सारस्वतम् ।

इति मूलकाव्यं यन्त्रोद्धारसूचकम् ।

तथा—

ॐ ॐ श्रीमनु सौं ततोऽपि च पुनः क्लीं वदद्वौ वाग्वादिनी
एतस्मादपि ह्रीं ततोऽपि च सरस्वत्यै नमोऽदः पदम् ।

अश्रान्तं निजभक्तिशक्तिवशतो यो ध्यायति प्रस्फुटं
बुद्धिज्ञानविचारसारसहितः स्याद्देव्यसौ साम्प्रतम् ॥

इति मूलमन्त्रोद्धारकाव्यं च ।

तथापि गुरुक्रमवशतः पाठान्तराणि दृश्यन्ते तत्र गुरुक्रम एव प्रमाणम् । भक्तानां
हि सर्वेऽपि फलन्तीति ।

ॐ ह्रीं आसिआउसा नमः अर्हं वाचिनि ! सत्यवाचिनि ! वाग्वादिनि वद वद
मम षक्त्रे व्यक्तवाचया ह्रीं सत्यं ब्रूहि ब्रूहि सत्यं वद वद अस्खलितप्रचारं सदेवमनु-
जासुरसदसि ह्रींअर्हं असिआउसा नमः स्वाहा ।

लक्षजापात् सिद्धिर्वृष्णभट्टि सारस्वतम् ।

इति श्रीवृष्णभट्टिसारस्वतकल्पः ।

वाग्भवं प्रथमं बीजं १ द्वितीयं कुसुमायुधम् २ ।
तृतीयं जीवसंज्ञं च सिद्धसारस्वतं स्मृतम् ॥
जीवसंज्ञं स्मरेद् गुह्ये वक्षसि (वक्षःस्थले) कुसुमायुधम् ।
शिरसि वाग्भवं बीजं शुकलवर्णं स्मरेत् त्रयम् ॥

त्रयम्-बीजत्रयमित्यर्थः ।

ॐ ह्रीं मण्डले आगच्छ आगच्छ स्वाहा । आह्वानम् ।

ॐ ह्रीं स्वस्थाने गच्छ गच्छ स्वाहा विसर्जनम् ।

ॐ अमृते ! अमृतोद्भवे ! अमृतमुखि ! अमृतं स्त्रावय स्त्रावय ॐ ह्रीं स्वाहा
इति सकलीकरणम् । इति शारदाकल्पः ।

ॐ नमो भगवओ अरिहओ भगवईए वाणीए वयमाणीए मम सरीरं पविस पविस
निस्सर निस्सर स्वाहा ।

लक्षं जापः । वाक्सिद्धिः फलति ।

ॐ नमो हिरीए बंभीए भगवईए सिज्जउ मे भगवई महाविज्जा ॐ बंभी महा-
बंभी स्वाहा ।

लक्षं पूर्वसेवायां जपः, तत्र त्रिसन्ध्यं सदा जपः ।

क्षिप ॐ स्वाहेति पञ्चतत्त्वरक्षा पूर्वं कार्या । प्राङ्मुखं च ध्यानम् । एष विधिः
सर्वसारस्वतोपयोगी ज्ञेयः ।

नमो अरिहंताणं, नमो सिद्धाणं, नमो आयरियाणं, नमो उवज्झायाणं, नमो लोए सब्ब-
साहूणं । नमो भगवईए सुअदेवयाए संघसुअमायाए बारसंगपवयणजणणीए सरस्सईए

सच्चवाइणि ! सुवण्णवण्णे ओअर ओअर देवी मम सरीरं पविस पुच्छंतस्स मुहं पविस सव्वजणमणहरी अरिहंतसिरी सिद्धसिरि आयरियसिरी उवज्झायसिरी सव्वसाहु-सिरी दंसणसिरी नाणसिरी चारित्तसिरी स्वाहा । सम्यग्दर्शनज्ञानचारित्राणि मोक्षमार्गः । अनेन मन्त्रेण कच्चोलकस्थं कंगुतैलं गजवेलक्षुरिकया वार १००८ अष्टोत्तरसहस्रं अथवा अष्टोत्तरशतं अभिमन्त्र्य पिवेत् महाप्रज्ञावुद्धिः प्रैधते । अनेन ब्राह्मीवच्चाऽभिमन्त्र्य भक्षणीया वाक्सिद्धिः । तथा पर्युपणापर्वणि यथाशक्ति पतत्स्मरणं कार्यं महैश्वर्यं वचनसिद्धिश्च ।

ॐ नमो अणाइनिहणे तित्थयरपगासिए गणहरेहिं अणुमणिणए द्वादशाङ्गचतुर्द-शपूर्वधारिणि श्रुतदेवते ! सरस्वति ! अवतर अवतर सत्यवादिनि हुं फद् स्वाहा । अनेन पुस्तिकादौ वासक्षेपः । लक्षजापे हुंफडग्रे च ॐ ह्रीं स्वाहा इत्युच्चारणे सार-स्वतं उपश्रुतौ कर्णाभिमन्त्रणं 'नमो धम्मस्स नमो संतिस्स नमो अजिअस्स इलि मिलि स्वाहा' चक्षुः कर्णौ च स्वस्याधिवास्य परस्य वा एकान्ते स्थितो यत् शृणोति तत्सत्यं भवति । उपश्रुतिमन्त्रः ॥

ॐ अर्हन्मुखकमलवासिनि ! पापात्मक्षयंकरि ! श्रुतज्ञानज्वालासहस्रप्रज्वलिते ! सरस्वति ! मत्पापं हन हन दह दह क्षां क्षीं क्षूं क्षौं क्षः क्षीरधवले ! अमृतसम्भवे ! वं वं हू क्ष्वीं ह्रीं क्लीं ह्रस्रौं वद वद वाग्वादिन्यै ह्रीं स्वाहा । चन्द्रचन्दनगुटिका दीपोत्सवे उपरागे शुभेऽह्नि वा अभिमन्त्र्य देया मेघाकरः । दक्षि-णशयं स्वं स्वयं मुखे दत्त्वा ५।७ गुण्या क्षोभता ।

चन्द्रचन्दनगुटीं रचयित्वा भक्षयेदनुदिनं सुपठित्वा ।

शिष्यवुद्धिवैभवकृते विहितेयं हेमसूरिगुरुणा करुणातः ॥

ऐं क्लीं ह्रीं ह्रस्रौं सरस्वत्यै नमः । जापः सहस्र ५० सारस्वतम् ।

ॐ क्लीं वद वद वाग्वादिनि ! ह्रीं नमः । अस्य लक्षजापे काव्यसिद्धिः । ध्याने च भगवती श्वेतवस्त्रा ध्यातव्येति

परिशिष्ट १३
साध्वीशिवार्याविरचितं
पठितसिद्धसारस्वतस्तवः ।

व्याप्तान्तसमस्तलोकनिकरैङ्कारा समस्ता स्थिरा,
याराध्या गुरुभिर्गुरोरपि गुरुदेवैस्तु या वन्द्यते ।
देवानामपि देवता वितरतात् वाग्देवता देवता
स्वाहान्तः क्षिप ॐ यतः स्तवमुखं यस्याः स मन्त्रो वरः ॥१॥

ॐ ह्रीं श्रीप्रथमा प्रसिद्धमहिमा सन्ततचित्ते हि या
सैं ऐं मध्यहिता जगत्त्रयहिता सर्वज्ञनाथाहिता ।
श्री क्लीं ब्ली चरमा गुणानुपरमा जायेत यस्या रमा
विद्यैषा वषडिन्द्रगोःपतिकरी वाणीं स्तुवे तामहम् ॥२॥

ॐ कर्णे ! वरकर्णभूषिततनुः कर्णेऽथ कर्णेश्वरी
ह्रींस्वाहान्तपदां समस्तविपदां छेत्री पदं सम्पदाम् ।
संसारार्णवतारिणी विजयते विद्यावदाते शुभे
यस्याः सा पदवी सदा शिवपुरे देवीवतंसीकृता ॥३॥

सर्वाचारविचारिणी प्रतरिणी नौर्वाग्भवाब्धौ नृणां
वीणावेणुवरक्वणातिसुभगा दुःखाद्रिविद्रावणी ।
सा वाणी प्रवणा महागुणगणा न्यायप्रवीणाऽमलं
शेते यस्तरणी रणीषु निपुणा जैनी पुनातु ध्रुवम् ॥४॥

ॐ ह्रीं बीजमुखा विधूतविमुखा संसेविता सन्मुखा
ऐं क्लीं सौं सहिता सुरेन्द्रमहिता विद्वज्जनेभ्यो हिता ।

विद्या विस्फुरति स्फुटं हितरतिर्यस्या विशुद्धा मतिः
 सा ब्राह्मी जिनवक्त्रवज्रलले लीना तु लीलानु माम् ॥५॥
 ॐ अर्हन्मुखपद्मवासिनि ! शुभे ! ज्वालासहस्रांशुभे
 पापप्रक्षयकारिणि ! श्रुतधरे ! पापं दहत्या शुभे ।
 क्षीं क्षीं क्षूं वरबीजदुग्धवले ! वं वं वहं स्वावहा
 श्रीवाग्देव्यमृतोद्भवे ! यदि भवे मे मानसे सा भवे ॥६॥
 हस्ते शर्मदपुस्तिकां विदधती सत्पात्रकं चापरं
 लोकानां सुखदं प्रभूतवरदं सज्ज्ञानमुद्रं परम् ।
 तुभ्यं बालमृणालकन्दललसलीलाविलोलं करं
 प्रख्याता श्रुतदेवता विदधती सूक्ष्मं नृणां सूनृतम् ! ॥७॥
 हंसो हंसोतिगर्वं वहति हि विधृता यन्मयैषा मयैषा
 यन्त्रं यन्त्रं यदेतत् स्फुटति सिततरां सैव यक्षावयक्षा ।
 साध्वी साध्वी शिवार्या प्रविधृतभुवना दुर्धरा या धराया
 देवी देवीजनार्थ्या रमतु मम सदा मानसे मानसे सा ॥८॥
 स्पष्टपाठं पठत्येतत् ध्यानेन पटुनाष्टकम् ।
 अजस्रं यो जनस्तस्य भवन्त्युत्तमसम्पदः ॥९॥



परिशिष्ट १४

श्रीजिनप्रभसूरिविरचितं सारस्वतमन्त्रगर्भितं

श्रीशारदास्तवनम् ।

ॐ नमस्त्रिदशवन्दितक्रमे ! सर्वविद्वज्जनपन्नभृङ्गिके ! ।
बुद्धिमान्द्यकदलीदलीक्रियाशस्त्रि ! तुभ्यमधिदेवते ! गिराम् ॥१॥
कुर्वते नभसि शोणशोचिषो भारति ! क्रमनखांशवस्तव ।
नम्रनाकिमुकुटांशुमिश्रिता बन्द्रकार्मुकपरम्परामिव ॥२॥
दन्तहीन्दुकमलत्रियो मुखं यैर्व्यलोकि तत्र देवि ! सादरम् ।
ते विविक्रकचितानिकेतनं के न भारति ! भवन्ति भूतले ? ॥३॥
श्रीन्द्रमुख्यविबुधार्चितक्रमां ये श्रयन्ति भवतीं तरीमिव ।
ते जगज्जननि ! जाड्यवारिधिं निस्तरन्ति तरसा रसास्पृशः ॥४॥
द्रव्यभावतिमिरापनोदिनीं तावकीनवदनेन्दुचन्द्रिकाम् ।
यस्य लोचनचकोरकद्वयी पीयते भुवि स एव पुण्यभाक् ॥५॥
विभ्रदङ्गकमिदं त्वदर्पितस्नेहमन्थरदृशा तरङ्गितम् ।
वर्णमात्रवदनाक्षमोऽप्यहं स्वं कृतार्थमवयामि निश्चितम् ॥६॥
मौक्तिकाक्षचलयाब्जकच्छपीपुस्तकाङ्कितकरोपशोभिते ! ।
पद्मवासिनि ! हिमोज्ज्वलाङ्गि वाग्वादिनि ! प्रभव नो भवच्छिन्दे ॥७॥
विश्वविश्वभुवनैकदीपिके ! नेमुपां मुपितमोहविप्लवे ! ।
भक्तिनिर्भरकवीन्द्रवन्दिते ! तुभ्यमस्तु गिरिदेवते नमः ॥८॥
उदारसारस्वतमन्त्रगर्भितं जिनप्रभाचार्यकृतं पठन्ति ये ।
घाग्देवतायाः स्फुटमेतदष्टकं स्फुरन्ति तेषां मधुरोज्ज्वला गिरः ॥९॥

परिशिष्ट १५
देवीस्तोत्रम्

श्रीसरस्वत्यै नमः ।

श्री शारदे ! नमस्तुभ्यं जगद्भवनदीपिके ! ।
विद्वज्जनमुखाभोजभृङ्गिके ! मे मुखे वस ॥१॥
वागीश्वरि ! नमस्तुभ्यं नमस्ते हंसगामिनि ! ।
नमस्तुभ्यं जगन्मातर्जगत्कर्त्रि ! नमोऽस्तु ते ॥२॥
शक्तिरूपे ! नमस्तुभ्यं कवीश्वरि ! नमोऽस्तु ते ।
नमस्तुभ्यं भगवति ! सरस्वति ! नमोऽस्तुते ॥३॥
जगन्मुख्ये नमस्तुभ्यं वरदायिनि ! ते नमः ।
नमोऽस्तु तेऽम्बिकादेवि ! जगत्पावनि ! ते नमः ॥४॥
शुक्लाम्बरे ! नमस्तुभ्यं ज्ञानदायिनि ! ते नमः ।
ब्रह्मरूपे ! नमस्तुभ्यं ब्रह्मपुत्रि ! नमोऽस्तु ते ॥५॥
विद्वन्मातर्नमस्तुभ्यं वीणाधारिणि ! ते नमः ।
सुरेश्वरि ! नमस्तुभ्यं नमस्ते सुरवन्दिते ! ॥६॥
भाषामयि ! नमस्तुभ्यं शुकधारिणि ! ते नमः ।
पङ्कजाक्षि ! नमस्तुभ्यं मालाधारिणि ! ते नमः ॥७॥
पद्मारूढे ! नमस्तुभ्यं पद्मधारिणि ! ते नमः ।
शुक्लरूपे नमस्तुभ्यं नमस्त्रिपुरसुन्दरि ! ॥८॥
धीदायिनि ! नमस्तुभ्यं ज्ञानरूपे ! नमोऽस्तुते ।
सुरार्चिते ! नमस्तुभ्यं भुवनेश्वरि ! ते नमः ॥९॥

१ सरस्वति । २ श्रीदायिनि !

कृपावति ! नमस्तुभ्यं यशोदायिनि ! ते नमः ।
 सुखप्रदे ! नमस्तुभ्यं नमः सौभाग्यवर्द्धिनि ! ॥१०॥
 विश्वेश्वरि ! नमस्तुभ्यं नमस्त्रैलोक्यधारिणि ! ।
 जगत्पूज्ये ! नमस्तुभ्यं विद्यां देहि महामहे ॥११॥
 श्रीर्देवते ! नमस्तुभ्यं जगदम्बे ! नमोऽस्तुते ।
 महादेवि ! नमस्तुभ्यं पुस्तकधारिणि ! ते नमः ॥१२॥
 कामप्रदे नमस्तुभ्यं श्रेयोमाङ्गल्यदायिनि ! ।
 सृष्टिकर्त्रि ! नमस्तुभ्यं सृष्टिधारिणि ! ते नमः ॥१३॥
 जगद्धिते ! नमस्तुभ्यं नमः संहारकारिणि ! ।
 विद्यामयि ! नमस्तुभ्यं विद्यां देहि दयावति ! ॥१४॥

अथ लक्ष्मीनामानि—

महालक्ष्मि ! नमस्तुभ्यं पीतवस्त्रे ! नमोऽस्तु ते ।
 पद्मालये ! नमस्तुभ्यं नमः पद्मविलोचने ! ॥१५॥
 सुवर्णाङ्गि ! नमस्तुभ्यं पद्महस्ते ! नमोऽस्तु ते ।
 नमस्तुभ्यं गजारूढे ! विश्वमात्रे नमोऽस्तु ते ॥१६॥
 शाकम्भरि ! नमस्तुभ्यं कामधात्रि ! नमोऽस्तु ते ।
 क्षीराब्धिजे ! नमस्तुभ्यं शशिस्वप्ने ! नमोऽस्तु ते ॥१७॥
 हरिप्रिये ! नमस्तुभ्यं धरदायिनि ! ते नमः ।
 सिन्दूराम्बे ! नमस्तुभ्यं नमः सन्मतिदायिनि ! ॥१८॥
 ललिते ! च नमस्तुभ्यं वसुदायिनि ! ते नमः ।
 शिवप्रदे ! नमस्तुभ्यं समृद्धि देहि मे रमे ! ॥१९॥

अथ योगिनीरूपाणि—

गणेश्वरि ! नमस्तुभ्यं दिव्ययोगिनि ते ! नमः ।
 विश्वरूपे ! नमस्तुभ्यं महायोगिनि ! ते नमः ॥२०॥
 भयङ्करि ! नमस्तुभ्यं सिद्धयोगिनि ! ते नमः ।
 चन्द्रकान्ते ! नमस्तुभ्यं अक्रेश्वरि ! नमोऽस्तु ते ॥२१॥

१ विद्यादेवि ! महामहे ! । २ नमस्ते सृष्टिधारिणि ! ।

पद्मावति ! नमस्तुभ्यं रुद्रवाहिनि ! ते नमः ।
 परमेश्वरि ! नमस्तुभ्यं कुण्डलिनि ! नमोऽस्तु ते ॥२२॥
 कलावति ! नमस्तुभ्यं मन्त्रवाहिनि ! ते नमः ।
 मङ्गले ! च नमस्तुभ्यं श्रीजयन्ति ! नमोस्तु ते ॥२३॥

अथान्यनामानि—

चण्डिके ! च नमस्तुभ्यं दुर्गे ! देवि ! नमोऽस्तु ते ।
 स्वाहारूपे ! नमस्तुभ्यं स्वधारूपे ! नमोऽस्तु ते ॥२४॥
 प्रत्यङ्गिरे ! नमस्तुभ्यं गोत्रदेवि ! नमोऽस्तु ते ।
 शिवे ! कृष्णे ! नमस्तुभ्यं नमः कैटभनाशिनि ! ॥२५॥
 कात्यायनि ! नमस्तुभ्यं नमो धूम्रविनाशिनि ! ।
 नारायणि ! नमस्तुभ्यं नमो महिषखण्डिनि ! ॥२६॥
 सहस्राक्षि ! नमस्तुभ्यं नमश्चण्डविनाशिनि !
 तपस्विनि ! नमस्तुभ्यं नमो मुण्डविनाशिनि ! ॥२७॥
 अग्निज्वाले ! नमस्तुभ्यं नमो निशुम्भखण्डिनि ! ।
 भद्रकालि ! नमस्तुभ्यं मधुमर्दिनि ! ते नमः ॥२८॥
 महाबले ! नमस्तुभ्यं शुम्भखण्डिनि ! ते नमः ।
 श्रुतिमयि ! नमस्तुभ्यं रक्तबीजवधे ! नमः ॥२९॥
 धृतिमयि ! नमस्तुभ्यं दैत्यमर्दिनि ! ते नमः ।
 दिवागते ! नमस्तुभ्यं ब्रह्मदायिनि ! ते नमः ॥३०॥
 माये ! क्रिये ! नमस्तुभ्यं श्रीमालिनि ! नमोऽस्तु ते ।
 मधुमति ! नमस्तुभ्यं कले ! कालि ! नमोऽस्तु ते ॥३१॥
 श्रीमातङ्गि ! नमस्तुभ्यं विजये ! च नमोऽस्तु ते ।
 जयदे च नमस्तुभ्यं श्रीशाम्भवि ! नमोऽस्तु ते ॥३२॥
 त्रिनयने ! नमस्तुभ्यं नमः शङ्करवल्लभे ! ।
 घागवादिनि ! नमस्तुभ्यं श्रीभैरवि ! नमोऽस्तु ते ॥३३॥
 मन्त्रमयि ! नमस्तुभ्यं क्षेमङ्करि ! नमोऽस्तु ते ।
 त्रिपुरे ! च नमस्तुभ्यं तारे शबरि ! ते नमः ॥३४॥
 हरसिद्धे ! नमस्तुभ्यं ब्रह्मवादिनि ! ते नमः ।
 भङ्गे ! बङ्गे ! नमस्तुभ्यं कालिके ! च नमोऽस्तु ते ॥३५॥

उमे ! नन्दे ! नमस्तुभ्यं यमघण्टे ! नमोऽस्तु ते ।
 श्रीकौमारि ! नमस्तुभ्यं वातकारिणि ! ते नमः ॥३६॥
 दीर्घदंष्ट्रे ! नमस्तुभ्यं महादंष्ट्रे ! नमोऽस्तु ते ।
 प्रभे ! रौद्रि ! नमस्तुभ्यं सुप्रभे ! ते नमो नमः ॥३७॥
 महाक्षमे ! नमस्तुभ्यं क्षमाकारि ! नमोऽस्तु ते ।
 सुतारिके ! नमस्तुभ्यं भद्रकालि ! नमोऽस्तु ते ॥३८॥
 चन्द्रावति ! नमस्तुभ्यं वनदेवि ! नमोऽस्तु ते ।
 नारसिद्धि ! नमस्तुभ्यं महाविद्ये ! नमोऽस्तु ते ॥३९॥
 अग्निहोत्रि ! नमस्तुभ्यं सूर्यपुत्रि ! नमोऽस्तु ते ।
 सुशीतले ! नमस्तुभ्यं ज्वालामुखि ! नमोऽस्तु ते ॥४०॥
 सुमङ्गले ! नमस्तुभ्यं वैश्वानरि ! नमोऽस्तु ते !
 निरञ्जने ! नमस्तुभ्यं श्रीवैष्णवि ! नमोऽस्तु ते ॥४१॥
 श्रीवाराहि ! नमस्तुभ्यं तोतलायै नमो नमः ।
 कुरुकुल्ले ! नमस्तुभ्यं भैरवपत्नि ! ते नमः ॥४२॥
 अधागमोक्तनामानि स्वयमूह्यानि पण्डितैः ।
 कथ्यन्ते कानि नामानि प्रसिद्धानि तथा न वा ॥४३॥
 हेमकान्ते ! नमस्तुभ्यं हिङ्गुलायै नमो नमः ।
 यज्ञविद्ये ! नमस्तुभ्यं वेदमातर्नमोऽस्तु ते ॥४४॥
 श्रीमृडानि नमस्तुभ्यं विन्ध्यवासिनि ! ते नमः ।
 पृथ्वीज्योत्स्ने ! नमस्तुभ्यं नमो नारदसेविते ! । ४५॥
 प्रह्लादिनि ! नमस्तुभ्यमपर्णायै नमो नमः ।
 जैनेश्वरि ! नमस्तुभ्यं सिंहगामिनि ! ते नमः ॥४६॥
 बौद्धमातर्नमस्तुभ्यं जिनमातर्नमोऽस्तु ते ।
 ॐकारे च नमस्तुभ्यं राज्यलक्ष्मि ! नमोऽस्तु ते ॥४७॥
 सुधात्मिके ! नमस्तुभ्यं राजनीते ! नमोऽस्तु ते ।
 मन्दाकिनि ! नमस्तुभ्यं गोदावरि ! नमोऽस्तु ते ॥४८॥
 पताकिनि ! नमस्तुभ्यं भगमालिनि ! ते नमः ।
 वज्रायुधे ! नमस्तुभ्यं परापरकले ! नमः ॥४९॥

षड्रहस्ते ! नमस्तुभ्यं मोक्षदायिनि ! ते नमः ।
 शतबाहु ! नमस्तुभ्यं कुलवासिनि ! ते नमः ॥१०॥
 श्रीत्रिशक्ते ! नमस्तुभ्यं नमश्चण्डपराक्रमे ! ।
 महाभुजे ! नमस्तुभ्यं नमः षट्चक्रभेदिनि ! ॥११॥
 नभःश्यामे ! नमस्तुभ्यं षट्चक्रक्रमवासिनि ! ।
 वसुप्रिये ! नमस्तुभ्यं रक्तादिनि नमो नमः ॥१२॥
 महामुद्रे ! नमस्तुभ्यमेकचक्षुर्नमोऽस्तु ते ।
 पुष्पबाणे ! नमस्तुभ्यं खगगामिनि ! ते नमः ॥१३॥
 मधुमत्ते नमस्तुभ्यं बहुवर्णे ! नमो नमः ।
 मदोद्धते ! नमस्तुभ्यं इन्द्रचापिनि ! ते नमः ॥१४॥
 चक्रहस्ते ! नमस्तुभ्यं श्रीखड्गिनि ! नमो नमः ।
 शक्तिहस्ते ! नमस्तुभ्यं नमस्त्रिशूलधारिणि ! ॥१५॥
 वसुधारे ! नमस्तुभ्यं नमो मयूरवाहिनि ! ।
 जालन्धरे ! नमस्तुभ्यं सुबाणायै नमो नमः ॥१६॥
 अन्तर्वीर्ये ! नमस्तुभ्यं वरायुधधरे ! नमः ।
 वृषप्रिये ! नमस्तुभ्यं शत्रुनाशिनि ! ते नमः ॥१७॥
 वेदशक्ते ! नमस्तुभ्यं वरधारिणि ! ते नमः ।
 वृषारूढे ! नमस्तुभ्यं वरदायै नमो नमः ॥१८॥
 शिवदूति ! नमस्तुभ्यं नमो धर्मपरायणे ! ।
 घनध्वनि ! नमस्तुभ्यं षट्कोणायै नमो नमः ॥१९॥
 जगद्गर्भे ! नमस्तुभ्यं त्रिकोणायै नमोनमः ।
 निराधारे ! नमस्तुभ्यं सत्यमार्गप्रबोधिनि ! ॥२०॥
 निराश्रये ! नमस्तुभ्यं छत्रच्छायाकृतालये ! ।
 निराकारे ! नमस्तुभ्यं वह्निकुण्डकृतालये ! ॥२१॥
 प्रभावति ! नमस्तुभ्यं रोगनाशिनि ! ते नमः ।
 तपोनिष्ठे ! नमस्तुभ्यं सिद्धिदायिनि ! ते नमः ॥२२॥
 त्रिसन्ध्यके ! नमस्तुभ्यं दृढबन्धविमोक्षणि ! ।
 तपोयुक्ते ! नमस्तुभ्यं काराबन्धविमोचनि ! ॥२३॥
 भेद्यमाले ! नमस्तुभ्यं भ्रमनाशिनि ! ते नमः ।
 ह्रींकारि ! नमस्तुभ्यं सामगायनि ! ते नमः ॥२४॥

ॐ षेरूपे ! नमस्तुभ्यं बीजरूपे ! नमोऽस्तु ते ।
 नृपवश्ये ! नमस्तुभ्यं शस्यवर्द्धिनि ! ते नमः ॥६५॥
 नृपसेव्ये ! नमस्तुभ्यं धनवर्द्धिनि ! ते नमः ।
 नृपमान्ये ! नमस्तुभ्यं लोकवश्यविधायिनि ! ॥६६॥
 नमः सर्वाक्षरमयि ! वर्णमालिनि ! ते नमः ।
 श्रीब्रह्माणि ! नमस्तुभ्यं चतुराश्रमवासिनि ! ॥६७॥
 शास्त्रमयि ! नमस्तुभ्यं वरशस्त्रास्त्रधारिणि ! ।
 तुष्टिदे ! च नमस्तुभ्यं पापनाशिनि ! ते नमः ॥६८॥
 पुष्टिदे ! च नमस्तुभ्यमार्तिनाशिनि ! ते नमः ।
 धर्मदे ! च नमस्तुभ्यं गायत्रीमयि ! ते नमः ॥६९॥
 कविप्रिये ! नमस्तुभ्यं चतुर्वर्गफलप्रदे ! ।
 जगज्जीवे ! नमस्तुभ्यं त्रिवर्गफलदायिनि ! ॥७०॥
 जगद्वीजे ! नमस्तुभ्यमष्टसिद्धिप्रदे ! नमः ।
 मातङ्गिनि ! नमस्तुभ्यं नमो वेदाङ्गधारिणि ! ॥७१॥
 हंसगते ! नमस्तुभ्यं परमार्थप्रबोधिनि !
 चतुर्बाहु ! नमस्तुभ्यं शैलवासिनि ते नमः ॥७२॥
 चतुर्मुखि ! नमस्तुभ्यं द्युतिवर्द्धिनि ! ते नमः ।
 चतुःसमुद्रशयिनि ! तुभ्यं देवि ! नमो नमः ॥७३॥
 कविशक्ते ! नमस्तुभ्यं कलिनाशिनि ! ते नमः ।
 कवित्वदे ! नमस्तुभ्यं मत्तमातङ्गगामिनि ! ॥७४॥



परिशिष्ट १६

श्रीअम्बिकाष्टकम्

व्यालोलालम्बमानप्रवणरणक्षणत्किङ्किणीक्काणरम्यं
ध्वस्तध्वान्तं समन्तान्मणिकिरणगणाडम्बरोल्लासितेन ।
देवी दिव्यांशुकानां ध्वजपटपटलैः शोभमानं विमानं
लीलारूढा भ्रमन्ती भुवनकृतनतिः पातु मामम्बिका सा ॥१॥

या देवी दिव्यदामाञ्चितचिकुरभरामोदमुग्धालिमाला-
भास्वन्माणिक्यमालामिलदमलमहोमण्डलीमण्डिताङ्गा ।
सन्मुक्तातारहारैर्गगनतलगतास्तारकास्तर्जयन्ती
वज्रालङ्कारभासा हसितरविकरा पातु मामम्बिका सा ॥२॥

या कौबेरं विहाय स्वपतिपरिभवात् साधुदानप्ररूढात्
स्थानं श्रान्तातिमार्गं श्रमशमनकृते संश्रिता चूतवृक्षम् ।
क्षुत्क्षामौ वीक्ष्य पुत्रौ कृतसुकृतवशात् प्रार्थयन्ती फलानि
क्षिप्रं सम्प्राप तानि स्वचरितमुदिता पातु मामम्बिका सा ॥३॥

देवी याऽत्रोपविष्टा सरणिगतपतिं वीक्ष्य कम्पं दधाना
स्मृत्वा श्री रैवतार्द्रिं व्यवसितमरणा साधुधर्मं स्मरन्ती ।
आरुह्योत्तुङ्गशृङ्गं प्रपतनविधिना दिव्यदेवत्वमाप्ता
जैनेन्द्रे पादपीठे सततनतशिराः पातुमामम्बिका सा ॥४॥

या पश्चात्तापतप्तं गतमदमदनं दुष्कृतं स्वं स्मरन्ती
दंष्ट्रास्यं पिङ्गनेत्रं खरनखरकरं केसरालीकरालं ।
पुच्छाच्छोटप्रकम्पावनिवलयतलं दिव्यसिंहं स्वकान्तं
संरूढा याति नित्यं जिनपतिनिलये पातु मामम्बिका सा ॥५॥



Goddess Ambika

अंबिकादेवी का उद्भव अशुभकाल में हुआ था। उस समय काशी में एक राजा का पुत्र मर गया था। राजा ने देवताओं से प्रार्थना की कि वह पुत्र को वापस लाने में सहायता करे। अंबिकादेवी ने राजा को बताया कि वह पुत्र को वापस लाने में सहायता करेगी, लेकिन राजा को अपने पुत्र को वापस लाने के लिए अंबिकादेवी का पूजन करना होगा। राजा ने अंबिकादेवी का पूजन किया और अंबिकादेवी ने राजा को पुत्र वापस लाने में सहायता की।

सान्द्राम्बालुम्बिहस्ता तरलहरिगता बालकाभ्यामुपेता
 ध्याता या सिद्धकामैर्विघटितडमरा साधकैर्भक्तियुक्तैः ।
 रक्ता रागानुरक्तैः स्फटिकमणिनिभा फलेशविध्वंसधीभिः
 पीता वश्यानुभावैर्विहितजनहिता पातु मामम्बिका सा ॥६॥
 देवी विधाधरेन्द्रासुरसुरमनुजैर्वन्द्यपादारविन्दा
 प्रत्यूहान्निक्षिपन्ती क्षपितकलिमला विभ्रती विश्वरक्षाम् ।
 जैनेन्द्रं शासनं या प्रकटयति महोत्साहशक्त्या स्वभक्त्या
 नित्यं नाम्ना नराणां विशदशिवफला पातु मामम्बिका सा ॥७॥
 एवं वृत्ताष्टकेन स्तुतिमुखरमुखः संस्तुतिं यः करोति
 ध्यानाधीनान्तरात्मा प्रशममुपगतो नित्यमेकाग्रचित्तः ।
 प्रातर्मध्ये निशायां शयनतलगतो यत्र कुत्रापि संस्थो
 देवी तस्य प्रकामं प्रकटयति पटुं प्रौढमम्बा प्रसादम् ॥८॥



परिशिष्ट १७

अम्बिकास्तुतिः ।

ॐ महातीर्थरैवतगिरिमण्डने ! जैनमार्गस्थिते ! विघ्नभीखण्डने ! ।
नेमिनाथाङ्घ्रिराजीवसेवापरे ! त्वं जयाम्बे ! जगज्जन्तुरक्षाकरे ! ॥१॥
हीं महामन्त्ररूपे ! शिवे ! शङ्करे ! देवि ! वाचालसत्किङ्किणीनूपुरे ! ।
तारहारावलीराजितोरःस्थले ! कर्णताडङ्करुचिरम्यगण्डस्थले ! ॥२॥
अम्बिके ! हाँ स्फुरद्वीजविद्ये ! स्वयं हीं समागच्छ मे देहि दुःखक्षयम् ।
हां हूँ तं द्रावय द्रावयोपद्रवान् हीं द्रुहि क्षुद्रसर्पेभकण्ठीरवान् ॥३॥
कलीं प्रचण्डे ! प्रसीद प्रसीद क्षणं बल्लू सदा प्रसन्ने ! विधेहीक्षणम् ।
सः सतां दत्तकल्याणमालोदये ! हूस्वल्हीं नमस्तेऽम्बिके ! अङ्कस्थपुत्रद्वये ॥४॥
इत्थमद्भूतमाहात्म्यमन्त्रस्तुते ! क्रौंसमालीढषट्कोणयन्त्रस्थिते ! ।
हींयुतेऽम्बे ! मरुन्मण्डलालङ्कृते ! देहि मे दर्शनं हीं त्रिरेखावृते ! ॥५॥
नाशिताशेषमिथ्यादृशां दुर्मदे ! शान्तिकीर्तिद्युतिस्वस्तिसिद्धिप्रदे ! ।
दुष्टविद्याबलोच्छेदनप्रत्यले ! नन्द नन्दाम्बिके ! निश्चले ! निर्मले ! ॥६॥
देवि ! कूष्माण्ड ! दिव्यांशुके ! भैरवे ! दुःसहे दुर्जये ! तप्तहेमच्छवे ! ।
नाममन्त्रेण निर्नाशितोपद्रवे ! पाहि मामंहिपीठस्थकण्ठीरवे ! ॥७॥
देवदेवीगणैः सेविताङ्घ्रिद्वये जागरूकप्रभावैकलक्ष्मीमये ! ।
पालिताशेषजैनेन्द्रचैत्यालये ! रक्ष मां रक्ष मां देवि ! अम्बालये ! ॥८॥

अत्र स्तुतौ गुप्तीकृतो मन्त्रस्त्वेवम्—

ॐ हीं अम्बिके ! हाँ हीं हाँ हीं कलीं बल्लू सः हूस्वल्हीं नमः ।

परिशिष्ट १८

अम्बिकाताटङ्कः ।

सिंहारूढा सुतयुगविभूषिता कम्पनम्रमध्यगता ।

साऽम्बा देवी तीर्थाधिवासिनी हरतु मम दुरितम् ॥१॥

ॐ ह्रीं जय जय परमेश्वरि ! श्रीअम्बिके ! आम्नहस्ते ! महासिंहयानस्थिते !
किङ्किणीनूपुरक्वाणकेयूरहाराङ्गदानेकसद्भूषणैर्विभूषिताङ्गे ! सर्वसल्लक्षणैर्लक्षिताङ्गे !
जिनेन्द्रस्य भक्ते ! कले ! निष्कले ! निष्प्रपञ्चे ! महाग्रानने ! सिद्धगन्धर्वविद्याधरे-
न्द्रार्चिते ! मन्त्रमूर्ते ! शिवे ! शङ्करे ! सिद्धिबुद्धिधृतिकीर्तिकान्तिविस्तारिणि !
शान्तिनिधितुष्टिपुष्टिहृष्टिप्रिये ! शोभने ! सुप्रहासे ! जरे ! जम्भिनि ! स्तम्भिनि !
मोहिनि ! दीपनि ! शोषणि ! त्रासिनि ! मोटिनि ! भञ्जिनि ! दुष्टसञ्चूर्णिनि ! क्षुद्र-
विद्रावणि ! शत्रुसञ्चूर्णिनि ! धार्मिकारक्षिणि ! देवि ! अम्बे ! महाविक्रमे ! भीम-
नादे ! सुनादे ! अघोरे ! सुघोरे ! सुरौद्रे ! सुरौद्रानने ! चण्डिके ! चण्डरूपे !
सुनेत्रे ! सुवक्त्रे ! सुगात्रे ! पवित्रे ! नमन्मध्यभागे ! जयन्ति ! जयन्ताकुमारी !
त्रैपुराङ्गि ! गौरि ! गान्धारि ! गन्धर्वि ! यक्षेश्वरि ! ॐ कालि ! कालि ! महाकालि !
योगेश्वरि ! जंनमार्गस्थिते ! सुप्रशस्ते ! धनुर्बाणदण्डासिचक्राम्बुजानेकशखोदिते !
सृष्टिसंहारकर्त्रि ! दिव्ये ! देन्द्रनागेन्द्रभूपेन्द्रचन्द्रस्तुते ! सुवर्णे ! पवित्रे ! महामूल-
विद्यास्थिते ! ॐ वषट्कारस्वाहाकारस्वधाकारह्रींकारकेंकारबीजान्विते ! दुःखदारिद्र्यदौ-
र्भाग्यनिर्नाशिनि ! लक्ष्मीधृतिकीर्तिकान्तिविस्तारिणि ! ह्रीं नमो यक्षेश्वरि ! ह्रीं देवि !
कुष्माण्डिके ! ह्रूं नमो देवि ! अम्बिके ! ह्रः सदा सर्वसिद्धिप्रदे ! अलं रक्ष रक्ष मां
देवि ! वादे विवादे रणे कानने शत्रुमध्ये इमशाने अग्नौ गिरौ रात्रौ सन्ध्याकाले विहस्तं
निरस्तं नभःस्थं निषण्णं प्रमत्तं भयैर्व्याघ्रसिंहैर्घराहैश्च रुद्धं तथा व्यालवेतालभूपालभीतं
ज्वरेणाभिभूतं कृतान्तेन नीतं नरेण उक्तं नरैराक्षसैर्देवि ! अम्बालये ! त्वत्प्रसादात्
शान्तिकं पौष्टिकं वश्यमाकर्षणं स्तम्भनं मोहनं दुष्टसञ्चूर्णनं धार्मिकारक्षणम् ।

परिशिष्ट १९

अम्बिकाताडङ्कम्

पठेत् स्मरेत् त्रिसन्ध्यं यो भक्त्या जिनपशासने ।
सम्प्राप्य मानुषान् लभते लभते सुभगां गतिम् ॥१॥
अम्बे ! दत्तावलम्बे ! त्वं मादृशां भव नित्यशः ।
श्रीधर्मकल्पलतिके ! प्रसीद वरदेऽम्बिके ! ॥२॥

ॐ ह्रीं आम्रकूष्माण्डिनि ! ह्रस्वल्ह्रीं नमः । अयं मूलमन्त्रः । द्वादश सहस्राणि रक्त-
कणबीरकुसुमैर्जापः, द्वादशांशेन होमः । जप्तपुष्पमध्यात् द्वादश शतानि छायाशुष्काणि
कृत्वा गुग्गुल-दधि-दुग्ध-मधु-घृतमिश्रो होमस्त्रिकोणकुण्डे देयः बदरीपलाससमिधैः ॥

ॐ ह्रीं आम्रकूष्माण्डिनि ! सर्वाङ्गसुन्दरि ! इवीं क्ष्वीं नमः ।
अयमपि तथैव साध्यः ।

ॐ ह्रीं आम्रकूष्माण्डिनि सर्वाङ्गसुन्दरि ! इवीं क्ष्वीं स्वप्नान्तरदेशं कुरु कुरु
स्वाहा ।

षट् सहस्राणि जापः अम्बिकामूर्तेः पुरतो भोगं कृत्वा सुप्यते चिन्तिताभिप्रायेण
स्वप्नं स्यात् ।

ॐ ह्रस्वल्ह्रीं ह्रस्रौं नमः । सहस्र ३ जापः, रक्तध्यानेन मञ्जिष्ठाऽरुणवसनां स्वर्णा-
भरणभूषिताङ्गीं सिंहारूढां अङ्गुलीलग्नैकडिम्भां अङ्गुस्थद्वितीयडिम्भां हेमवर्णां चतुर्भुजां
उपरितनवामकराङ्गुशां उपरितनदक्षिणकरात्तप्रलुम्बीं अधस्तनदक्षिणकरबीजपूरां अध-
स्तनवामकरपाशां देवीमम्बिकां ध्यायेत् पकेनैवासने (न) जपः कार्यः । रक्तध्यानेन
विशिष्टफलमफलं रागवदयादि स्वप्नोपदेशश्च ।

ॐ ह्रीं कूष्माण्डिनि ! कनकप्रभे ! सिंहमस्तकसमारूढे ! जिनधर्मसुवत्सले !
महादेवि ! मम चिन्तितकार्येषु शुभाशुभं कथय कथय अमोघवागीश्वरि ! सत्यवादिनि !
सत्यं दर्शय दर्शय स्वाहा ॥

अम्बिकामन्त्रः सत्प्रत्ययः ।

ॐ ह्रीं अम्बिके ! ह्रीं ह्रीं ह्रीं ह्रीं क्लीं ल्लूं सः ह्रस्वक्लीं नमः । अयमम्बिकामन्त्रः
ॐ ह्रीं अंबा अंबालुंबि हि लुंबिया ह्रीं । १०८ षणमासान् यावत् महाभक्त्या स्मरेत् ।
पुत्रं लभते ।

ॐ ह्रीं अम्बे ! आं क्रौं ह्रीं ह्रीं क्लीं ल्लूं सः ह्रस्वक्लीं नमः । इदं यन्त्रं पवि-
त्रपट्टके यक्षकर्दमकणवीरपुष्पैर्जापो दिनसप्तकेन द्वादश सहस्राणि ततः पुरु घृतमधु-
खण्डमिश्रजप्तकुसुमदशांशचूर्णेन गुटिका शत १२ त्रिकोणकुण्डे होमः । ततोऽम्बिका
सिद्धा स्यात् । विश्वशोभण-स्त्र्याकर्षण-पात्रावतार-स्वप्नादेशसिद्धिर्मुद्गलादिग्रहनिग्रहं च
विदधाति । अन्यदपि हितं सम्पादयति ।

ॐ आकाशगामिनि ! नगरपुरपाटनक्षोभिणि ! रायराणासामन्तमोहिनि ! ॐ
अम्बिकादेवि ! ह्रीं फद् स्वाहा ।

जातिपुष्पैः सहस्राणि १० जापः । इति पूर्वसेवा । नित्यं च वार २१ जापः । वार
३ थूकमन्त्री वामकनिष्ठया पुण्ड्रं सभावश्यम् ।

ॐ आकाशगामिनि ! नगरपुरपाटनक्षोभिणि ! रायराणाभमात्यवशीकरणी ॐ ह्रीं
अम्बिके ! हुं फद् स्वाहा । २१ स्मरणा ।

ॐ ह्रीं अम्बिके ! उज्जयन्तनिवासिनि ! सर्वकल्याणकारिणि ! ह्रीं नमः । स्मरणा ।

ॐ ह्रीं सिद्धमात अम्बिके ! मम सर्वसिद्धि देहि देहि ह्रीं नमः । सदा
स्मरणा कार्या ।

ॐ क्लीं हर हर ठः ठः सर्वदुष्टान् वशीकुरु कुरु त्रिपुरक्षोभिनि ! त्रिपुरवशी-
करणि ! ॐ ह्रीं अम्बिके ! स्वाहा । सदा स्मरणा ।

ॐ नमो भगवति ! कूष्माण्डिनि ! क्ष्मी ह्रीं ह्रीं शासनदेवि ! अवतर अवतर
घटे दर्पणे जले वाममेतं कायं सत्यं ब्रूहि ब्रूहि स्वाहा । दीपे कन्या शुभाशुभं वक्ति ।

ॐ ह्रीं रक्ते ! महारक्ते ! प्रौं शासनदेवि ! पहि पहि अवतर अवतर स्वाहा ।

ॐ ह्रीं रक्ते ! महारक्ते ! ह्रौं ह्रस्वक्लीं ह्रस्वल्लूं शासनदेवि ! पहि पहि अवतर
अवतर स्वाहा ।

ॐ ह्रीं अम्बे ! अम्बकूष्माण्डे ! रक्ते ! रक्तवले ! अवतर अवतर एहि एहि शीघ्र-
मानय आनय मम चिन्तितं कार्यं कथय कथय ॐ ह्रीं स्वाहा । दीपावतारमन्त्रः ।

ॐकारसम्पुटस्थानं हयरेहपरिय.....।
बिंदुकलासंजुतं लिहह सनामं सयाकालं ॥१॥
पुव्वाई अट्टदलं सु...मणं लिहह भुज्जपत्तम्मि ।
दंसणनाणच्चरिस्ता तव चतुरो छहि पुव्वाइं ॥२॥
चन्दणकप्पूरेणं लिहह क्रम पञ्चबाणमन्तेहिं ।
अद्दाहं सेयकुसुमेहिं अट्टुत्तरं जाव ॥३॥
कांपाविअम्बिपणं गंधक्खयधूवकुसुमदीवेहिं ।
अण्णं चिय इट्टधुरं पण जं जरइ देवपण मन्तेणं ॥४॥
पुण पुत्तह वरकण्णा दीवणमज्झम्मि मीइ जं रूवं ।
सहं वा आअम्बइ सुहासुहं तं फुडं होइ ॥५॥



परिशिष्ट २०
महामात्यश्रीवस्तुपालविरचितं
श्रीअम्बिकास्तवनम्

पुण्ये गिरीशशिरसि प्रथितावतारामासूत्रितत्रिजगतीदुरितापहाराम् ।
दौर्गत्यपातिजनताजनितावलम्बामम्बामहं महिमहैमवतीं महेयम् ॥१॥
यद्वक्त्रकुञ्जरहरोद्गतसिंहनादोऽप्युन्मादिविघ्नकरियूथकथाममाथम् ।
कूष्माण्डि खण्डयतु दुर्विनयेन कण्ठः कण्ठीरवः स तव भक्तिनतेषु भीतिम् ॥२॥
कूष्माण्डि ! मण्डनमभूत्तव पादपद्मयुग्मं यदीयहृदयावनिमण्डलस्य ।
पद्मालया नवनिवासविशेषलाभलुब्धा न धावति कुतोऽपि ततः परेण ॥३॥
दारिद्र्यदुर्दमतमःशमनप्रदीपाः सन्तानकाननघनाघनवारिधाराः ।
दुःखोपतप्तजनबालमृणालदण्डाः कूष्माण्डि ! पातु पदपद्मनखांशवस्ते ॥४॥
देवि ! प्रकाशयति सन्ततमेष कामं वामेतरस्तव करश्चरणानतानाम् ।
कुर्वन् पुरः प्रगुणितां सहकारलुम्बिमम्ब्रे ! विलम्बविकलस्य फलस्य लाभम् ॥५॥
हन्तुं जनस्य दुरितां त्वरिता त्वमेव नित्यं त्वमेव जिनशासनरक्षणाय ।
देवि ! त्वमेव पुरुषोत्तममाननीया कामं विभासि विभया सभया त्वमेव ॥६॥
तेषां मृगेश्वरगरज्वरमारिवैरिदुर्वारवारणजलज्वलनोद्भवा भीः ।
उच्छृङ्खलं न खलु खेलति येषु धत्से वात्सल्यपल्लवितमम्बकमम्बिके ! त्वम् ॥७॥
देवि ! त्वदूर्जितजितप्रतिपन्थितीर्थयात्राविधौ बुधजनाननरङ्गसङ्घि ।
पतत्वयि स्तुतिनिभाद्भुतकल्पवल्लीहल्लीसकं सकलसंघमनोमुदेंऽस्तु ॥८॥
वरदे ! कल्पवल्लि ! त्वं स्तुतिरूपे ! सरस्वति ! ।
पादाग्रानुगतं भक्तं लम्भयस्वातुलैः फलैः ॥९॥
स्तोत्रं श्रोत्ररसायनं श्रुतसरस्वानम्बिकायाः पुर-
श्चक्रे गूर्जरचक्रवर्तिसचिवः 'श्रीवस्तुपालः' कविः ।
प्राप्तः प्रातरधीयमानमनघं यच्चित्तवृत्ति सता-
माधत्ते विभुतां च ताण्डवयति श्रेयःश्रियं पुष्यति ॥१०॥

इत्यम्बिकास्तुतिः ।

परिशिष्ट २१
श्रीजिनेश्वरसूरिविरचिता
श्रीअम्बिकादेवीस्तुतिः

देवगन्धर्वविद्याधरैर्वन्दिते जय जयामित्रविप्रासने विश्रुते ।
नूपुरारावसुनिरुद्धभुवनोदरे मुखरतरकिङ्किणीचारुतारस्वरे ॥१॥
ॐ ह्रीं मन्त्ररूपे शिवे शङ्करे अम्बिके देवि ! जय जन्तुरक्षाकरे ।
स्फुरत्तारहारावलीराजितोरःस्थले कर्णताटङ्गरुचिरम्यगण्डस्थले ॥२॥
स्तम्भिनी मोहिनी ईश उच्चाटने क्षुद्रविद्राविणी दोषनिर्णाशिनी ।
जम्भिनी भ्रान्तिभूतग्रहस्फोटिनी शान्तिधृतिकीर्त्तिमतिसिद्धिसंसाधिनी ॥३॥
ॐ महामन्त्रविद्येऽनवद्ये स्वयं ह्रीं समागच्छ मे देवि दुरितक्षयम् ।
ॐ प्रचण्डे प्रसीद प्रसीद क्षणं (हे) सदानन्दरूपे विधेहि क्षणम् ॥४॥
ॐ नमो देवि दिव्येश्वमे भैरवे जयेऽपराजिते तप्तहेमच्छवे ! ।
ॐ जगज्जननि संहारसम्मार्जनी ह्रीं कूर्माण्डि ! दिव्याधिविध्वंसिनी ॥५॥
पिङ्गतारोत्पतन्नीमकण्ठीरवे नाममन्त्रेण निर्णाशितोपद्रवे ।
अवतरावतर रैवतगिरिनिवासिनि अम्बिके ! जय जय त्वं जगत्स्वामिनी ॥६॥
ह्रीं महाविघ्नसङ्घातनिर्णाशिनी दुष्टपरमन्त्रविद्याबलच्छेदिनी ।
हस्तविन्यस्तसहकारफललुम्बिका हरतु दुरितानि देवी ! जगत्यम्बिका ॥७॥
इति श्रीजिनेश्वरसूरिभिरम्बिका भगवती शुभमन्त्रपदैः स्तुता ।
प्रवरपात्रगता शुभसम्पदं वितरतु प्रणिहन्त्वशिवं मम ॥८॥

इति श्रीअम्बिकादेवीस्तुतिः ॥

चक्रेश्वरी (अप्रतिचक्र) ३४



Goddess Chakreshwari

“अप्रतिचक्रासि गान्धर्वी शिववर्णा गङ्गायाम्बुजात्पद्मवापाय चक्रावतूष्णं मीढा-
भरां पञ्चवचसः दत्तामरुतां चैव ॥”
निर्वाणकलिकायाम्

परिशिष्ट २२
श्रीजिनदत्तसूरिविरचितम्
श्रीचक्रेश्वरीस्तोत्रम्

श्रीचक्रेश्वरि चक्रचुम्बितकरे चञ्चलकुण्डला-
लंकारे कृतमस्तकोरुमुकुटे त्रैवेयकालंकृते ॥
स्फारोदारभुजाप्रभूषणकरे सन्नूपुरैर्बन्धुरे
मातर्मन्ति नयं स्वमिष्टविनयं त्रायस्व संत्रासतः ॥१॥

श्रीचक्रेश्वरी चन्द्रमण्डलमिव ध्वस्तांधकारोत्करं
भव्यप्राणिचकोरचुम्बितकरं संतापसंपद्धरं ।
सम्यग्दृष्टिसुखप्रदं सुविशदं कान्त्यास्पदं संपदां
पात्रं जीवमनःप्रसादजनकं भाति त्वदीयं मुखम् ॥२॥

श्रीचक्रेश्वरी युष्मदाननरविं पश्यन्ति नैवोदितं
ध्वस्तध्वान्तततिं प्रदत्तसुगतिं संप्राप्तमार्गस्थितिं ।
ते ज्ञेया इह कौशिका इव जना हेयाः सतां सर्वथा
नादेयाः कुदृशो भवन्ति भगवत्युच्चैःशिवं वाञ्छतां ॥३॥

श्रीचक्रेश्वरी युष्मदंघ्रिचरितं सर्वत्र तद्विश्रुतं ।
कस्याज्ञस्य मनोमुदे भवति नो निष्पुण्यचूडामणेः ।
कारुण्यान्वितमंगिसंमतमतिभ्रान्तिप्रशान्तप्रियं
श्रीसंकेतगृहं सदास्तविरहं पुण्यानुबन्धि स्फुटम् ॥४॥

श्रीचक्रेश्वरि ये स्तुवन्ति भवतीं भव्या भवद्भक्तयः ।
श्रीसर्वज्ञपदारविन्दयुगले विश्राममातन्वतीम् ॥

भृङ्गीवत्सदृशां सुखं त्वसदृशं संप्रार्थयन्तो जना-
 स्ते स्युर्ध्वस्तविपत्तयः सुमतयः स्पष्टं जितारातयः ॥१॥
 श्रीचक्रेश्वरि नित्यमेव भवतीनामाऽपि ये सादरं ।
 सन्तः सत्यशमाश्रिताः प्रतिपदं सम्यक् स्मरन्ति स्फुरत् ॥
 तेषां किं दुरितानि यान्ति निकटे नायाति किं श्रीर्गृहे ।
 नोपैति द्विषतां गणोऽपि विलयं नाऽभीष्टसिद्धिर्भवेत् ॥६॥
 श्रीचक्रेश्वरि ये भवन्ति भवतीपादारावेन्दाश्रिता-
 स्ते भृङ्गा इव कामितार्थमधुनः पात्रं सदैवाङ्गिनः ।
 जायन्ते जगति प्रतीतिभवनं भव्याः स्फुरत्कीर्त्तय-
 स्तेषां कापि कदापि सा भवति नो दारिद्र्यमुद्रा गृहे ॥७॥
 श्रीचक्रेश्वरि यः स्तवं तव करोत्युच्चैः स किं मानवः
 कस्मादन्यजनाच्च याचत इह क्लेशैर्विमुक्ताशयः ।
 कासश्वासशिरोगलग्रहकटीवातातिसारज्वर-
 स्रोतोनेत्रगतामयैरपि न स श्रेयानिह प्रार्थते ॥८॥
 श्रीचक्रेश्वरि शासनं जिनपतेस्तद्रक्षसि त्वं मुदा
 ये केचिज्जिनभाषितान्यवितथान्युच्चैः प्रजल्पन्ति च ।
 भव्यानां पुरतो हितानि कुरुषे तेषां तु तुष्टिं सदा
 क्षुद्रोपद्रवविद्रवं प्रतिपदं कृत्वा कृतान्तादपि ॥९॥
 श्रीचक्रेश्वरि विश्वविस्मयकरी त्वं कल्पवृक्षोपमा
 घत्सेऽभीष्टफलानि वस्तुनिकृतिं दत्से विना संशयं ।
 तेन त्वं विजुता मयाऽपि भवती मत्वेति मन्निश्चयं
 कुर्याः श्रीजिनदत्तभक्तिषु मनो मे सर्वदा सर्वथा ॥१०॥

इति श्रीचक्रेश्वरीस्तोत्रं संपूर्णम्

परिशिष्ट २३

॥ श्रीचक्रेश्वरीअष्टकम् ॥

श्रीचक्रे ! चक्रभीमे ! ललितवरभुजे ! लीलया लोलयन्ती
चक्रं विद्युत्प्रकाशं ज्वलितशितशिखं खे खगेन्द्राधिरूढे ! !
तत्त्वैरुद्भूतभावे सकलगुणनिधे ! त्वं महामन्त्रमूर्तिः [मूर्ते]
क्रोधादित्यप्रतापे ! त्रिभुवनमहिते ! पाहि मां देवि ! चक्रे ! ॥१॥
कल्लौ कल्लौ कल्लौकारचित्ते ! कलिकलिवदने ! दुन्दुभिभीमनादे !
हौं ह्रीं हः सः खबीजे ! खगपतिगमने ! मोहिनी शोषिणी त्वम् ।
तच्चक्रं चक्रदेवी भ्रमसि जगति दिक्चक्रविक्रान्तकीर्ति-
विघ्नौघं विघ्नयन्ती विजयजयकरी पाहि मां देवि ! चक्रे ! ॥२॥
श्रीं श्रीं श्रीं श्रः प्रसिद्धे ! जनितजनमनःप्रीतिसन्तोषलक्ष्मीं
श्रीवृद्धिं कीर्तिकान्तिं प्रथयसि वरदे ! त्वं महामन्त्रमूर्तिः [मूर्ते] ।
प्रलोक्यं क्षोभयन्तीमसुरभिदुरहुङ्कारनादैकभीमे !
कल्लौ कल्लौ कल्लौ द्रावयन्ती हुतकनकनिभे पाहि मां देवि ! चक्रे ! ॥३॥
वज्रक्रोधे ! सुभीमे ! शशिकरधवले ! भ्रामयन्ती सुचक्रं
हौं ह्रीं हूं हः कराले ! भगवति ! वरदे ! रुद्रनेत्रे ! सुकान्ते !
श्रीं ईं उं क्षोभयन्ती त्रिभुवनमखिलं तत्त्वतेजःप्रकाशि
ज्वां ज्वां ज्वां सच्चबीजे प्रलयविषयुते ! पाहि मां देवि ! चक्रे* ! ॥४॥
ॐ ह्रीं हूं हः सहर्षे [र्षे] हहहहहसिते' चक्रसङ्काशबीजे !
हौं हौं हः यः क्षीरवर्णे ! कुवलयनयने ! विद्रवं द्रावयन्ती ।

* क्षौं क्षौं क्षुं क्षोभयन्ती विषमविषयुते ! पाहि मां देवि ! चक्रे !-पाठान्तरे

१-हरहसितसिते

ह्रीं ह्रीं (ह्रौं) हः क्षः त्रिलोकैरमृतजरजरैर्वारणैः प्लावयन्ती
 हां ह्रीं ह्रीं चन्द्रनेत्रे ! भगवति सततं पाहि मां देवि ! चक्रे ! ॥५॥
 आं आं आं ह्रीं युगान्ते प्रलयविचयुते^१ कारकोटिप्रतापे !
 चक्राणि भ्रामयन्ती विमलवरभुजे पद्ममेकं फलं च ।
 सच्चक्रे कुङ्कुमाङ्गैर्विधृतवि[व]निरुहं तीक्ष्णरौद्रप्रचण्डे
 ह्रीं ह्रीं ह्रींकारकारीरमरगणतनो [वो] पाहि मां देवि ! चक्रे ! ॥६॥
 आँ श्रीं श्रूं श्रः ॐसवृत्तिस्त्रिभुवनमहिते नादविन्दुत्रिनेत्रे
 वं वं वं वज्रहस्ते ललललललिते नीलशोनीलकोषे ।
 चं चं चं चक्रधारी चलचलचलते^२ नूपुरालीढलोले
 त्वं लक्ष्मीं श्रीसुकीर्तिं सुरवरविनते पाहि मां देवि ! चक्रे ! ॥७॥
 ॐ ह्रीं ह्रूंकारमन्त्रे कलिमलमथने^३ तुष्टिवश्याधिकारे
 ह्रीं ह्रौं हः यः प्रघोषे प्रलययुगजटीज्ञेयशब्दप्रणादे ।
 यां यां यां क्रोधमूर्ते ! ज्वलज्वलज्वलिते ज्वालसंज्वाललीढे
 आँ ह्रूं ॐ अः प्रघोषे प्रकटितदशने पाहि मां देवि ! चक्रे ! ॥८॥
 यः स्तोत्रं मन्त्ररूपं पठति निजमनोभक्तिपूर्वं शृणोति
 त्रैलोक्यं तस्य वश्यं भवति बुधजनो वाक्पटुत्वञ्च दिव्यं ।
 सौभाग्यं स्त्रीषु मध्ये खगपतिगमने गौरवं त्वत्प्रसादात्
 डाकिन्यो गुह्यकाश्च विदधति न भयं चक्रदेव्याः स्तवेन ॥९॥

॥ इति श्रीचक्रेश्वरीदेवीस्तोत्रम् ॥

१-ज्वां ज्वीं ज्वीं सत्त्वबीजे ! प्रलयविषयुते पाहि मां देवि ! चक्रे !

२-प्रलयदिनकरे, ३-प्रवृत्तिः, ४-कलिते

५-कलिकलिमथने

परिशिष्ट २४

॥ श्रीचतुःषष्टियोगिनीस्तोत्रम् ॥

ॐ ह्रीं दिव्ययोगी १ महायोगी २ सिद्धयोगी ३ गणेश्वरी ४ ।
प्रेताशी ५ डाकिनी ६ काली ७ कालि(ल)रात्रि ८ निशाचरी ९ ॥१॥
हुंकारी १० सिद्धवैताली ११ ह्रींकारी १२ भूतडामरी १३ ।
ऊर्ध्वकेशी १४ विरूपाक्षी १५ शुक्लाङ्गी १६ नरभोजिनी १७ ॥२॥
षट्कारी १८ वीरभद्रा च १९ धूम्राक्षी २० कलहप्रिया २१ ।
राक्षसी २२ घोररक्ताक्षी २३ विश्वरूपा २४ भयंकरी २५ ॥३॥
वैरी २६ कुमारिका २७ चण्डी २८ वाराही २९ मुण्डधारिणी ३० ।
भास्करी ३१ राष्ट्रटङ्कारी ३२ भीषणी ३३ त्रिपुरान्तका ३४ ॥४॥
रौरवी ३५ ध्वंसिनी ३६ क्रोधा ३७ दुर्मुखी ३८ प्रेतवाहनी ३९ ।
खन्वाङ्गी ४० दीर्घलंबोष्ठी ४१ मालिनी ४२ मन्त्रयोगिनी ४३ ॥५॥
कालिनी ४४ त्राहिनी ४५ चक्री ४६ कंकाली ४७ भुवनेश्वरी ४८ ।
कटी ४९ निकटी ५० माया च ५१ वामदेवा कपर्दिनी ५२ ॥६॥
केशमर्दी च ५३ रक्ता च ५४ रामजंघा ५५ महर्षिणी ५६ ।
विशाली ५७ कार्मुकी ५८ लोला काकटप्रिधोमुखी ५९ ॥७॥
मडोयधारिणी ६० व्याघ्री ६१ भूतादिप्रेतनाशिनी ६२ ।
भैरवी च महामाया ६३ कपालिनी वृथाङ्गनी ६४ ॥८॥
चतुषष्टिः समाख्याता योगिन्यो वरदाः प्रदाः ।
त्रैलोक्ये पूजिता नित्यं देवमानवयोगिभिः ॥९॥
चतुर्दश्यां तथाष्टम्यां संक्रातौ नवमीषु च ।
यः पठेत् पुरतो भूत्वा तस्य विघ्नं प्रणश्यति ॥१०॥
राजद्वारे तथोद्वेगे संग्रामे अरिसंकटे ।
अग्निचौरनिपातेषु सर्वग्रहविनाशिनि ॥११॥
य इमां जपते नित्यं शरीरे भयमागते ।
स्मृत्वा नारायणी देवी सर्वोपद्रवनाशिनी ॥१२॥

परिशिष्ट २५

ज्वालामालिनीमन्त्रस्तोत्रम् ।

ॐ नमो भगवते श्रीचन्द्रप्रभजिनेन्द्राय शशाङ्कशङ्खगोक्षीरहारधवलगात्राय घाति-
कर्मनिर्मूलोच्छेदनकराय जातिजरामरणविनाशनाय त्रैलोक्यवशङ्कराय सर्वासत्त्वहितङ्कराय
सुरासुरेन्द्रमुकुटकोटिघृष्टपादपीठाय संसारकान्तारोन्मूलनाय अचिन्त्यबलपराक्रमाय
अप्रतिहतचक्राय त्रैलोक्यनाथाय देवाधिदेवाय धर्मचक्राधीश्वराय सर्वविद्यापरमेश्वराय
कुविद्यानिधनाय,

तत्पादपङ्कजाश्रमनिषेविणि ! देवि ! शासनदेवते ! त्रिभुवनसङ्क्षोमिणि ! त्रैलो-
क्याशिवापहारकारिणि ! स्थावरजङ्गमविषमविषसंहारकारिणि ! सर्वाभिचारकर्माभ्यवहा-
रिणि ! परविद्याच्छेदिनि ! परमन्त्रप्रणाशिनि ! अष्टमहानागकुलोच्चाटनि ! कालदुष्टमृ-
तकोत्थापिनि ! सर्वविघ्नविनाशिनि ! सर्वरोगप्रमोचनि ! ब्रह्मविष्णुरुद्रेन्द्रचन्द्रादित्य-
ग्रहनक्षत्रोत्पातमरणभयपीडासंमर्दिनि ! त्रैलोक्यमहिते ! भव्यलोकहितङ्करि ! विश्वलो-
कवशङ्करि ! अत्र महाभैरवरूपधारिणि ! महाभीमे ! भीमरूपधारिणि ! महारौद्रि !
रौद्ररूपधारिणि ! प्रसिद्धसिद्धविद्याधरयक्षराक्षसगरुडगन्धर्वकिन्नरकिंपुरुषदैत्योरगरुद्रेन्द्र-
पूजिते ! ज्वालामालाकरालितदिगन्तराले ! महामहिपवाहने ! खेटककृपाणत्रिशूलहस्ते !
शक्तिचक्रपाशशरासनविशिखपविराजमाने ! षोडशार्द्धभुजे ! पहि पहि ह्म्ल्यूर् ज्वाला-
मालिनि ! ह्रीं कँली ब्लँ फट् द्राँ द्रीं हाँ ह्रीं ह्रँ ह्रँ ह्रँ ह्रः ह्रीं देवान् आकर्षय आकर्षय, सर्व-
दुष्टग्रहान् आकर्षय आकर्षय, नागग्रहान् आकर्षय आकर्षय, यक्षग्रहान् आकर्षय आकर्षय,
राक्षसग्रहान् आकर्षय आकर्षय, गान्धर्वग्रहान् आकर्षय आकर्षय, गान्धार्यग्रहान् आक-
र्षय आकर्षय, ब्रह्मग्रहान् आकर्षय आकर्षय, भूतग्रहान् आकर्षय आकर्षय, सर्वदुष्टान्
आकर्षय आकर्षय, चोरचिन्ताग्रहान् आकर्षय आकर्षय, कटकट कम्पावय कम्पावय, शीर्षं
चालय चालय, बाहुं चालय चालय, गात्रं चालय चालय, पाटुं चालाय चालय, सर्वाङ्गं
चालय चालय, लोलय लोलय, धूनय धूनय, कम्पय कम्पय, शीघ्रमवतारं गृणह गृणह,

ग्राहय ग्राहय, अचेलय अचेलय आवेशय आवेशय इम्ल्यूर्णुं ज्वालामालिनि ! ह्रीं क्लीं ब्लूँ
 द्राँ द्रीं ज्वल ज्वल र र र र र र रां प्रज्वल प्रज्वल, ह्रूं प्रज्वल प्रज्वल, धगधगधू-
 मान्धकारिणि ! ज्वल ज्वल, ज्वलितशिखे ! देवग्रहान् दह दह, गन्धर्वग्रहान् दह दह,
 यक्षग्रहान् दह दह, भूतग्रहान् दह दह, ब्रह्मराक्षसग्रहान् दह दह, व्यन्तरग्रहान् दह
 दह, नागग्रहान् दह दह, सर्वदुष्टग्रहान् दह दह, शतकोटिदैवतान् दह दह, सहस्रको-
 टिपिशाचराजान् दह दह, घे घे स्फोटय स्फोटय, मारय मारय, दहनाक्षि ! प्रलय
 प्रलय, धगधगितमुखे ! ज्वालामालिनि ! ह्राँ ह्रीं ह्रूं ह्रीं हः सर्वग्रहहृदयं दह दह,
 पच पच, छिन्द छिन्द, भिन्धि भिन्धि हः हः हाः हाः हेः हेः हुं फट् फट् घे घे
 इम्ल्यूर्णुं क्ष्राँ क्ष्रीं क्ष्रूं क्ष्रीं क्ष्रः स्तम्भय स्तम्भय, हा पूर्व बन्धय बन्धय, दक्षिणं
 बन्धय बन्धय, पश्चिमं बन्धय बन्धय, उत्तरं बन्धय बन्धय, इम्ल्यूर्णुं भ्राँ भ्रीं भ्रूं
 भ्राँ भ्रः ताडय ताडय, म्ल्यूर्णुं भ्राँ भ्रीं भ्रूं भ्राँ भ्रः नेत्रे यः स्फोटय स्फोटय, दर्शय
 दर्शय, इम्ल्यूर्णुं प्राँ प्रीं प्रूं प्रीं प्रः प्रेषय प्रेषय, इम्ल्यूर्णुं घ्राँ घ्रीं घ्रूं घ्राँ घ्रः जठरं मेदय
 मेदय, इम्ल्यूर्णुं झ्राँ झ्रीं झ्रूं झ्रीं झ्रः मुष्टिवन्धेन बन्धय बन्धय, इम्ल्यूर्णुं ख्राँ ख्रीं ख्रूं ख्राँ ख्रः
 ग्रीवां भञ्जय भञ्जय, इम्ल्यूर्णुं छ्राँ छ्रीं छ्रूं छ्रीं छ्रः अन्तराणि छेदय छेदय, इम्ल्यूर्णुं त्राँ त्रीं
 त्रूं त्रीं त्रः महाविद्यापाषाणालैः हन हन, इम्ल्यूर्णुं ब्राँ ब्रीं ब्रूं ब्रीं ब्रः समुद्रे ! जृम्भय
 जृम्भय, झ्राँ झ्रः घ्राँ ड्राँ घ्रः सर्वडाकिनीः मर्दय मर्दय, सर्वयोगिनीः तर्जय तर्जय, सर्व-
 शत्रून् ग्रस ग्रस, खं खं खं खं खं खं खादय खादय, सर्वदैत्यान् विध्वंसय विध्वंसय
 सर्वमृत्युन् नाशय, नाशय, सर्वोपद्रवं महाभयं स्तम्भय स्तम्भय, दह २ पच २ मथ २
 ययः २ धम २ धरू २ खरू २ खङ्गरावणसुविद्या घातय २ पातय २ सच्चन्द्रहासशस्त्रेण
 छेदय २ मेदय २ झरू २ छरू २ हरू २ फट् २ घेः ह्राँ ह्राँ आँ केाँ क्ष्वीं ह्रीं क्लीं ब्लूँ द्राँ
 द्रीं केाँ क्षीं क्षीं क्षीं क्षीं क्षीं ज्वालामालिनी आज्ञापयति स्वाहा ॥

इति सर्वरोगहरस्तोत्रम् ॥

श्रीमायाबीजस्तोत्रम् ।

सुवर्णवर्णं लयमध्यसिद्धमधीश्वरं भास्वरभानुरूपम् ।

खण्डेन्दुबिन्दुस्फुटनादशोभं त्वां शक्तिबीजं प्रमनाः प्रणौमि ॥१॥

ह्रींकारमेकाक्षरमादिरूपं त्रैलोक्यवर्णं परमेष्ठिबीजम् ।

मायाक्षरं कामदमादिमन्त्रं तज्ज्ञाः स्तुवन्तीश ! भवन्तमित्थम् ॥२॥

शैक्षः सुशिक्षा सुगुरोरवाप्य शुचिर्वशी धीरमनाश्च मौनी ।

त्वदात्मबीजस्य तनोति जापमपाशु नित्यं विधिना विधिज्ञः ॥३॥
त्वां चिन्तयन् श्वेतकरानुकारं ज्योत्स्नामयीं पश्यति यस्त्रिलोकीम् ।
श्रयन्ति तं तत्क्षणतोऽनवद्याः विद्याकलाशान्तिकपौष्टिकानि ॥४॥

त्वामेव बालारुणमण्डलाभं स्मृत्वा जगत्त्वत्करजालदीप्रम् !
विलोकते यः किल तस्य विश्वं विश्वं भवेद् वश्यमवश्यमेव ॥५॥
यस्तप्तचामीकरचारुदीप्रं पिङ्गप्रभं त्वां कलयेत् समन्तात् ।
सदा मुदा तस्य गृहे सहेलं करोति केरिं कमला चलापि ॥६॥
यः श्यामलं कज्जलमेचकाभं त्वां वीक्षते चातुषधूमधूमम् ।

विपक्षपक्षः खलु तस्य वाताहताघ्नवद् यात्यचिरेण नाशम् ॥७॥
आधारकन्दोद्गततन्तुसूक्ष्मलक्ष्मोन्मिषद्ब्रह्मसरोजवासम् ।
यो ध्यायति त्वां स्रवदिन्दुविम्बामृतः स च स्यात् कविसार्वभौमः ॥८॥
षड्दर्शनी स्वस्वमतावलेपात् स्वे दैवते तन्मयबीजमेव ।
ध्यात्वा तदाराधनवैभवेन भवेदजेया परवादिवृन्दैः ॥९॥

किं मन्त्रतन्त्रैर्विविधागमोक्तिदुःसाधसंशीतिफलाल्पलाभैः ॥
सुसाध्यसद्यःफलचिन्तितार्थाधिकप्रदश्चेतसि चेत् त्वमेकः ॥१०॥
चौरारिमारिग्रहरोगलूताभूतादिदोषानिलबन्धनोत्थाः ।
भियः प्रभावात् तव दूरमेव नश्यन्ति पारीन्द्ररवादिवेभाः ॥११॥
प्राप्नोत्यपुत्रः सुतमर्थहीनः श्रीदायते पत्तिरपीशते ह ।
दुःखी सुखी वाऽथ भवेन्न किं किं त्वद्रूपचिन्तामणिचिन्तितेन ॥१२॥
पुष्पादिजापामृतहोमपूजाक्रियाधिकारः सकलोऽस्तु दूरे ।

यः केवलं ध्यायति बीजमेव सौभाग्यलक्ष्मीर्वृणुते स्वयं तम् ॥१३॥
त्वत्तोऽपि लोकः सुकृतार्थकाममोक्षान् पुमर्थाश्च नरा लभन्ते ।
यास्यन्ति याता अथ यान्ति ये वा श्रेयःपदं त्वन्महिमालवः सः ॥१४॥
विधाय या प्राक् प्रणवं नमोऽन्ते मध्ये च बीजं ननु जञ्जपीति ।
तस्यैकवर्णा वितनोत्यवन्ध्या कामार्जुनी कामितमेव विद्या ॥१५॥

मालामिमां स्तुतिमयीं सगुणां त्रिलोकी-

बीजस्य यः स्वहृदये कुरुते त्रिसन्ध्यम् ।

अङ्गेऽष्टसिद्धिरवशा लुठतीह तस्य

नित्यं महोदयपदं लभते क्रमात् सः ॥१६॥



Goddess Sarvastra-mahajwala

सर्वोस्त्रमहाज्वालायां चतुर्भुजा सराष्ट्रप्रदनां शयनप्रदरणयुतहस्तां चित्रे ॥ — विष्णोणकवि सा गम्

ज्वालामालिनी यंत्र ।

<p>द्वल्युं द्वल्युं द्वल्युं क्रौं क्रौं क्रौं ज्वालामालिनी देवी नमः ददादिदी दुदूदेदौदौदंदः द्रेद्रौद्रौद्रः दुष्टान् वारय २ स्वाहा श्री नमः १</p>	<p>ह्रल्युं ह्रल्युं ह्रल्युं क्रौं क्रौं क्रौं ज्वालामालिनी देवी नमः दहाहिहीहुहूहेहैहोहौहंहः ह्रौं ह्रीं ह्रूं ह्रः सर्वदुष्टजीवान् वश्यं कुरु २ फट् स्वाहा २</p>	<p>क्षल्युं क्षल्युं क्षल्युं क्रौं क्रौं क्रौं ज्वालामालिनी देवी नमः क्षशाक्षिशीक्षुक्षुक्षैक्षोक्षौक्षं क्षः सर्वजनवश्यं दुष्टजनवश्यं कुरु २ स्वाहा. ३</p>
<p>भ्रल्युं भ्रल्युं भ्रल्युं क्रौं क्रौं क्रौं ज्वालामालिनी देवी नमः भभाभिभीभुभूभैभैभोभौभंभः सर्वजनवश्यं दुष्टजनवश्यं कुरु २ स्वाहा श्री नमः ४</p>	<p>म्रल्युं म्रल्युं म्रल्युं क्रौं क्रौं क्रौं ज्वालामालिनी देवी नमः ममामिमीमुमूमेमैमोमौमंमः सर्वजनवश्यं दुष्टजनवश्यं कुरु २ स्वाहा श्री नमः ५</p>	<p>ज्रल्युं ज्रल्युं ज्रल्युं क्रौं क्रौं क्रौं ज्वालामालिनी देवी नमः जजाजिजीजुजूजेजैजोजूजंजः सर्वजनवश्यं कुरु २ स्वाहा श्री नमः ६</p>
<p>य्रल्युं य्रल्युं य्रल्युं क्रौं क्रौं क्रौं ज्वालामालिनी देवी नमः ययायियीयुयूयेयैयोयौयंयः सर्वजनवश्यं दुष्टजनवश्यं कुरु २ स्वाहा श्री नमः ७</p>	<p>घ्रल्युं घ्रल्युं घ्रल्युं क्रौं क्रौं क्रौं घ्रौं घ्रूं घ्रैं घ्रौं दुन घ्रौं घ्रः शशष्टान् त्रय २ यय नन श्रीघोराक्षयमसुरस्य नमः स्वाहा ८</p>	<p>क्रल्युं क्रल्युं क्रल्युं क्रौं क्रौं क्रौं ज्वालामालिनी देवी नमः क्रौं क्रीं क्रूं कें क्रौं क्रः दुष्टा घभन् २ पर्यबन्ध परान् निट् ॐ फुट् स्वाहा ९</p>
<p>ख्रल्युं ख्रल्युं ख्रल्युं क्रौं क्रौं क्रौं ज्वालामालिनी देवी नमः ख्रौं ख्रैं ख्रूं ख्रौं ख्रः दुष्टज- नान् वश्यं जट नमनाश्री भंजय २ स्वाहा कुरुभ्यं नमः १०</p>	<p>च्रल्युं च्रल्युं च्रल्युं क्रौं क्रौं क्रौं ज्वालामालिनी देवी नमः च्रौं च्रीं च्रैं च्रूं च्रौं च्रौं दु- ष्टान् कृजतात्रान् मंथ २ छेदय २ ॐ ह्रीं फुट् स्वाहा श्री नमः ११</p>	<p>व्रल्युं व्रल्युं व्रल्युं क्रौं क्रौं क्रौं ज्वालामालिनी देवी नमः व्रौं व्रं व्रौं व्रौं व्रं व्रः दु- ष्टानानि वदनाविरुधवररम- कयकार फुट् २ स्वाहा श्रीनमः १२</p>

लक्ष्मीः इदं यन्त्रम् । विधिः—दीपालिकायां कृष्णचतुर्दश्यां षष्ठव्रततपः कृत्वा पवित्री-
भूत्वा अष्टगन्धकेन अगुरुधूपोत्क्षेपणपूर्वकं सदशपीताम्बरं परिधाय स्वर्णलेखिन्या लिख-
नीयम् । ततः षट्कोणैककुण्डं कृत्वा अष्टोत्तरशतसंख्येयनालीकेरपूगीलवंगजातीफल-
पलादिकपञ्चामृतं सार्द्धपञ्चपञ्चसेरसंख्याकं अग्नौ जुहुयात् । संपूर्णम् ॥

परिशिष्ट २६

श्रीगर्भस्तोत्रम्

ह्रींकारोदरवाग्भवैकवसतिर्या कुण्डली कौलिनी
ब्रह्मानन्दमयी परा परकला षड्ग्रन्थिसम्भेदिनी ।
साहस्रं पदपद्मकोटरलसत्सोमेन सार्द्धं मुदा
क्रीडन्ती सुखसम्पदं दिशतु नः श्रीमत्त्रिखण्डेश्वरी ॥१॥

श्रीमत्पञ्चदशाक्षरी शिवकलाधारादिचक्रेषु या
स्फूर्तिः पञ्चदशस्तथोनवतया त्रेधापि या संस्थिता ।
उन्मन्यन्तमुपागता कुलकजप्रोहामसौदामिनी
मायामोहनिकृन्तिनी निजसुखं मह्यं प्रसद्यात् सदा ॥२॥

कश्चित् पङ्कजसम्भवः करुणया पूर्णस्त्वया विश्वसृक्
वेदादिविद्यदादितत्त्वममलं त्वत्सामरस्यं स्फुटम् ।
तद्वेदत्रिपुरे कृपामृतरसोन्मथ्याऽप्यनन्या श्रिये
दृष्टिं देहि ततः समुज्ज्वलतरानन्दस्वभावो भवे ॥३॥

पतत् ते त्रिपुरे ! त्वदीयवपुषा सा चित्रवर्णाध्वना
व्यस्तं विश्वमनुत्तरोत्तरतया यद्वीजमुद्गीयते ।
तन्मे ताण्डवमण्डितं रसनिका सारस्वतेनाहतं
विस्फूर्जत्कलकोकिलारजतयोद्वेलं जरीञ्चृम्भते ॥४॥

ईकारोऽसि हुताशनेन्दुतपनैर्बिन्दुत्रयैः संयुतः
कामाप्ताजननी स्थितिं वितनुते ब्रह्मैक्यः केशवः ।
यत्वं देवि ! पुरे सुधारसवचः कल्लोलकल्लोलिनी
जिह्वातः प्रसरीसरीतु भवती कारुण्यतस्तद्द्रुतः ॥५॥

लक्ष्मीं लक्ष्मिललामधामबहुलां मत्तेभकुम्भोच्छल-
 दानाम्भोत्कटपूरपङ्कविकटां देह्यम्ब ! मह्यं यतः ।
 त्वं सृष्टिस्थितिमेदिनी मधुजितः शक्तिर्विरञ्चेर्निजा
 यद्वा वाग्भवमध्यगा विलससि श्रीमत्त्रिखण्डेश्वरि ! ॥६॥

ह्रींकारादिहराब्जयोनिविलसत्संसारसङ्कोचिनी
 या बेयारतयेश्वरस्य महिता वागेश्वरी जृम्भते ।
 बिन्दौ नादतया च बीजवसतिर्याऽनुत्तरा शाश्वती
 श्रीमत्त्रिपुरसुन्दरी विजयते खण्डे स्थिता वास्तवे ॥७॥

हः कामः शिवबीजतो हरिरयं यन्मोहयत्यङ्गना
 स्थित्या त्वच्चरणप्रसादवशतः श्रीकामराजादितः ।
 मातर्भक्तिसमीहितं सृजति यद्वैर्यं.....रं श्रयः ।
 सोऽयं मेऽखिलकाङ्क्षितं वितरतात् कामेश्वरप्रेयसी ॥८॥

सत्तारूपिणि ! सज्जनैकनिलये ! सौभाग्यसम्पत्प्रदे !
 सावित्रीति सरस्वतीति गदिता लक्ष्मीस्त्वमेवासि सा ।
 तत् कामेश्वरशम्भुपत्नि ! मम यत् काङ्क्षाधिरूढं भवेत्
 तद्देहि त्वरितं तपोभिरपि यद् दुष्प्रापमन्यैरपि ॥९॥

कल्याणं कमलापतिः करुणया कामेश्वरः काङ्क्षितं
 दद्यान्मध्यमखण्डतस्तव शवे मध्ये स्थितः कान्मना ।
 कन्दर्पप्रतिमः कलासु कुशलः कल्पद्रुमः कामिनां
 यस्योच्चारवशेन राजति नरः श्रीमत्त्रिखण्डात्मिके ! ॥१०॥

हस्त्वन्माध्यमखण्डले च वसतिर्योऽम्ब ! द्वितीयस्थितिं
 पुष्पात्येकतयैव चाधिकतया बन्धूकपुष्पप्रभः ।
 सौभाग्यं परमं स मे वितरता वश्या भवेयुर्यतो
 राजानो वरयोपितश्च निभृताः सौख्यश्रियः सम्मता ॥११॥

लक्ष्यं मे मनसो मनोरमतमं सौन्दर्यसौमालयो
 बन्धूकप्रभवारुणं करलसच्चापेषु पाशाङ्कशम् ।
 काञ्चीनद्धनितम्बबिम्बसुभगं मध्ये न किञ्चिच्च यत्
 रूपं ते कुचचक्रवाकखिलसच्चन्द्रालिकं स्तात् सदा ॥१२॥

ह्रींकारे हरमान्मथोन्दुरणितैः श्रीकामराजान्तिगे
 खण्डे मण्डनमावहन्ति हरयः सङ्कोचतः संस्थिते ।

रुद्रः शक्तियुतश्च मन्मथकलाकामेश्वरेणेन्दुना
 नादात्मा च परापरेण भवतान्मत्कामसम्पूर्तये ॥१३॥
 सच्चित्सौख्यमखण्डितं शिवमयं शक्तिस्वरूपोल्लस-
 च्छार्तीये तव संहृतौ प्रथमतः सद्बृत्ततोज्ज्वम्भते ।
 शङ्कातङ्ककलङ्कभावजनितं भेदः प्रथातः शिवे
 तन्मे पूर्णशशाङ्कमण्डलनिभं कुर्यादशं दूरतः ॥१४॥
 कश्चिज्जन्मशतार्जितेन तपसा तत्पादपद्मद्वये
 जातप्रीतिरनन्यभावमनसा लब्ध्वा गुरोः सत्कृपाम् ।
 कं वेद त्रिपुरे तृतीयंशकले कामेश्वराख्यं हरिं
 पूर्णानन्दविभूतिदं त्रिजगतीवश्यंकरं तं श्रये ॥१५॥
 लब्ध्वादेशकराजवीक्षणकृपां त्वां वेद कामेश्वरीं
 धन्यो यस्त्रिपुरे ! त्वदङ्घ्रिकृपया विश्वात्मसाम्राज्यभूः ।
 लक्ष्मीस्तं वृणुते कटाक्षवशतस्तस्य ज्वरोपप्लवा
 नाशं यान्ति सदा विषाणि च महावेतालभूतग्रहाः ॥१६॥
 श्रीमत्यम्ब ! विराजते तव परं खण्डं तृतीयान्तिमं
 बीजं तत्र हरौ हरौ प्रथमतो या रुद्रशक्तिः स्वयम् ।
 संहारैकरसो मनोभवकलावह्नीन्दुसूरा परा
 बिन्दुर्योऽपि परेश्वरो मम सदा कुर्वन्तु ते मङ्गलम् ॥१७॥

१ ३० स्वर्भूः रेखा ३ । स्वः—सामवेदः, भूः—यजुर्वेदः, भूः—ऋग्वेदः । पुरुषः, स्त्री, नपुंसकः
 सत्त्वम्, रजः, तमः, । ब्रह्मा, विष्णुः, महेशः । कल्पवृक्षः, चिन्तामणिः, कामधेनुः । देवतत्त्वम्,
 गुरुतत्त्वम्, धर्मतत्त्वम् । ज्ञानम्, दर्शनं चारित्र्यम् च ।

परिशिष्ट २७
श्रीधराचार्यविरचितः
श्रीपद्मावतीस्तोत्रम्

ॐ जगन्तीभमातङ्गी सर्वदुष्टक्षयंकरी ।
पद्मासने पद्मदेवी च महापद्मे नमोनमः ॥१॥
देवी त्वं ध्यायिता इन्द्रे पूजिता शिवसंकरे ।
कृष्णेन संस्तुता देवी महापद्मे नमोनमः ॥२॥
सावित्रि पतिमाराध्य वासुकै सेविता भृशम् ।
तेषां संतुक्षते देवी महापद्मे नमोनमः ॥३॥
पद्माम्बरधरा देवी पद्मद्रहनिवासिनी !
पद्मायुधधरा नित्यं महापद्मे नमोनमः ॥४॥
यस्यां प्रसन्नतां पद्मे तस्यां दारिद्र्यनाशने ।
जय त्वं सुखदाता च महापद्मे नमोनमः ॥५॥
देवि ! दारिद्र्यदग्धाहं तन्मेसं संकरीभव ।
चित्तिता वरदाता च महापद्मे नमोनमः ॥६॥
पद्मावती यस्या गृहे पूजिता जगदीश्वरी ।
हृदये यस्य वर्तन्ते तस्य सौख्यं निरन्तरम् ॥७॥
इदं स्तोत्रं पवित्रं च श्रीधराचार्यभाषितं ।
एकाग्रमनसा साध्यं तस्य सौख्यं निरन्तरम् ॥८॥
रणे राजकुले चैव दुर्गमे शत्रुसंकटे ।
महावने महाभीमे विघ्नो यांति दिसो दिसा ॥९॥
अपुत्रो लभते पुत्रं धनार्थी लभते धनं ।
विद्यार्थी लभते विद्यां सुखार्थी लभते सुखं ॥१०॥

॥ इति श्रीपद्मावतीस्तोत्रं सम्पूर्णम् ॥

परिशिष्ट २८

श्रीपद्मावतीकवचम् ।

भगवन् ! सर्वमाख्यातं मन्त्रं यन्त्रं शुभप्रदम् ।
पद्मायाः कवचं ब्रूहि यद्यहं तव वल्लभः ॥ १ ॥
महागोप्यं महागुह्यं पद्मायाः सर्वकामदम् ।
कवचं मोहनं देवि ! गुरुभक्ताय दीयते ॥ २ ॥
राज्यं देयं च सर्वस्वं कवचं न प्रकाशयेत् ।
गुरुभक्ताय दातव्यमन्यथा सिद्धिदं न हि ॥ ३ ॥
ऐं बीजम् । क्लीं शक्तिः । ह्रौं कीलकम् ।
पद्मावतीप्रीत्यर्थं जपे विनियोगः ।
ॐ परब्रह्मणे नमः शिरसि । अनुपुण्ड्रन्दो यो नमः मुखे ।
श्रीपद्मावतीशक्तिदेवतायै नमः हृदये । आं बीजाय नमः कण्ठे ।
हीं शक्तये नमः गुह्ये । क्रौं कीलकाय नमः पादयोः ।
श्रीपद्मावतीकवचसिद्धयर्थं जपे विनियोगः ॥
ॐ पद्मा बीजं शिरः पातु ललाटं पञ्चमी परा ।
नेत्रे कामप्रदा पातु मुखं भुवनसुन्दरी ॥ ४ ॥
नाशिका नागनाथश्च जिह्वां वागीश्वरी तथा ।
श्रुतिरूपा जगद्धात्री करौ हृत् हिमवासिनी ॥ ५ ॥
उदरं मोहदमनी कुण्डली नाभिमण्डलम् ।
पार्श्वं पृष्ठं कर्णं गुह्यं शक्तिस्थाननिवासिनी ॥ ६ ॥
ऊरू जङ्घे तथा पादौ सर्वविघ्नविनाशिनी ।
रक्ष रक्ष महामाये पद्मे ! पद्मालये शिवे ॥ ७ ॥

वाञ्छितं पूरयत्याशु पद्मा सा पातु सर्वतः ।
इदं तु कवचं देव्या यो जानाति स मन्त्रवित् ॥ ८ ॥
राजद्वारे श्मशाने च भूतप्रेतोपचारके ।
बन्धने च महादुःखे भये शत्रुसमागमे ॥ ९ ॥
स्मरणात् कवचस्यास्य भयं किञ्चिन्न जायते ।
प्रयोगमुपचारं च पद्मायाः कर्तुमिच्छति ॥ १० ॥
कवचं प्रपठेदादौ ततः सिद्धिमवाप्नुयात् ।
भूर्यपत्रे लिखित्वा तु कवचं यस्तु धारयेत् ॥ ११ ॥
देहे च यत्र कुत्रापि सर्वसिद्धिर्भवेद् ध्रुवम् ।
शस्त्राग्निजं भयं नैव भूतादिभयनाशनम् ॥ १२ ॥
गुरुभक्तिं समासाद्य पद्मायाः स्तवनं कुरु ।
सहस्रनामपठने कवचं प्रथमं कुरु ॥ १३ ॥
नन्दिना कथितं देवि ! तवाग्रे तत् प्रकाशितम् ।
साङ्गता जायते देवि ! नान्यथा गिरिनन्दिनी ॥ १४ ॥
इदं कवचमज्ञात्वा पद्मायाः स्तौति यो नरः ।
कल्पकोटीशतेनापि न भवेत् सिद्धिदायिनी ॥ १५ ॥



परिशिष्ट २९

सूरिविद्यास्तोत्रम्



पढमपप सुपइट्टा विज्जाप सूरिणो गुणनिहिस्स ।
गोयमपयभत्तिजुआ सरस्सई मह सुहं देउ ॥१॥
दुइयट्टाणनिविट्टा इमाइ विज्जाइ निरुवममहप्पा ।
तिहुयणसामिणि नाम सहस्सभुयसंजुया संता ॥२॥
सिरिगोयमपयकमलं झायन्ती माणुसुत्तरनगस्स ।
सिहरम्मि ठिया णिच्चं संघस्स य मह सुहं देउ ॥३॥
दुइयट्टाणनिविट्टा चउसट्टिसुराहिवाण मयमहणी ।
सव्वंगभूसणधरा पणमन्ती गोयममुणिंदं ॥४॥
विज्या जया जयन्ती नन्दाभहासमणिआ तइप ।
विज्जापप निविट्टा सिरिसिरिदेवी सुहं देउ ॥५॥
विज्जाचउत्थट्टाणे निवेसिओ गोयमस्स अभिमुहिओ ।
गणिपिंडजक्खराओ अणपणपणीकयपइट्टो ॥६॥
सोलसहस्सजक्खाण सामिओऽतुलवलो य वीसभुओ ।
जिणसासणपडिणीयं मह रिउवगं निवारेउ ॥७॥
सोहम्मकप्पवासी एरावणवाहणो य वज्जकरो ।
सेवइ तियसाहिवई सगोयमं मन्तवररायं ॥८॥
ईसाणकप्पवासी सूलकरो वसहसंठिओ निच्चं ।
सेवइ तियसाहिवई सगोयमं मन्तवररायं ॥९॥
तइयकप्पनिवासी सिरिसुमणो नामओ य चक्कधरो ।
सेवइ तियसाहिवई सगोयमं मन्तवररायं ॥१०॥

सिरिबम्भलोयवासी सोमणसो नामओ य बहुसत्थो ।
 सेवइ तियसाहिवई सगोयमं मन्तवररायं ॥११॥
 अट्टकुलनागराओ सहसफणो सिरनिविट्टकरमउलो ।
 सेवइ धरणिंदो विय सगोयमं मन्तवररायं ॥१२॥
 रोहिणिपमुहा देवी चउसट्टिसुराहिवा तहा अन्ने ।
 सेवइ गोयमचरणे जक्खा जक्खाण चउघीसं ॥१३॥
 कणयमयसहस्सपत्ते कमलम्मि निवेसिओ उ लद्धिजुओ ।
 बहुपाडिहेरकलिओ ज्ञायव्वो गोयममुणिंदो ॥१४॥
 आं क्रैं ह्रीं श्रीं पपणं मन्तेणं ज्ञाणारंमे ठविज्जप णिच्चं ।
 अंगुलिमुहाकरणे सन्निहियसुरस्स समवाओ ॥१५॥
 सन्निहियसुरवराणं उस्सग्गो कीरप सुपूया य ।
 कप्पूरधूववासेहिं सव्वहा विहियबम्भवओ ॥१६॥
 थोवजलविहियन्हाणो वरवत्थविभूसिओ य तिक्कालं ।
 कम्मक्खयहेउं जो सुमरइ विज्जं इमं लक्खं ॥१७॥
 ॐ किरिपिरिसिरिहिरि आयरिय पयस्स मन्तरायस्स ।
 जावं तिलक्खमाणं करेइ जो सो गोयमो होइ ॥१८॥
 सोहणपयपरमिट्ठी पवयणसुरही कयंजली चेव ।
 मुहापञ्चकमेय कायव्वं सव्वकालच्चं ॥१९॥
 किं चिंतामणिकामघेणुकप्पद्दुमसुंदरु
 नवनिहिचउदसरयणपवरच्चक्कित्तणुसहयरु ।
 जा मुणिवइसिरिसूरिविज्जगोयमसुपइट्टिय
 भुवणत्तय अक्खलियमहप्प निट्टियकम्मट्टय ॥२०॥

परिशिष्ट ३०
आचार्यश्रीभद्रगुप्तविरचिता
अनुभवसिद्धमन्त्रद्वात्रिंशिका ।

प्रणम्य श्रीमहावीरं विद्यारत्नमहानिधिम् ।
मन्त्रद्वात्रिंशिकां वक्ष्ये सर्वकार्यप्रसाधिकाम् ॥१॥
स्तम्भनं मोहमुच्चाटं वक्ष्याकर्षणजम्भनम् ।
विद्वेषणं मारणं च शान्तिकं पौष्टिकं तथा ॥२॥
मुक्तिमार्गं च शास्त्रेऽत्र भणिष्यामि यथाविधि ।
एकाग्रीभूय भो भव्याः श्रूयतां भक्तिपूर्वकम् ॥३॥
१सर्वज्ञाभं महामन्त्रं सर्वकल्याणकारकम् ।
सर्वकर्मकरं चैव साधयेच्च यथाविधि ॥४॥
ब्रह्मत्रिलोककमला अकारं नमसोऽक्षरम् ।
रेफचिन्दुकलाक्रान्तं नमश्च मन्त्र उच्यते ॥५॥
२पीतं स्तम्भेऽरुणं वक्ष्ये क्षोभणे विद्रुमप्रभम् ।
कृष्णं विद्वेषणे ध्यायेत् कर्मघाते शशिप्रभम् ॥६॥
द्वादशसहस्रजापो दशांशहोमेन सिद्धिमुपयाति ।
मन्त्रो गुरुप्रसादाद् ज्ञातव्यस्त्रिभुवने सारः ॥७॥

श्रीयोगशास्त्रस्वोपज्ञवृत्त्यनुसारि टिप्पनकम् ।

१ ॐ श्रीं ह्रीं अर्हं नमः इत्येवं लक्षणम् ।

२ यद्यपि कर्मघातार्थिनां शशिप्रभस्यैव प्रणवस्य ध्यानमुच्यते, तथापि तत्तद्द्रव्यक्षेत्रकाल-
भावसामग्रीवशेन पीतादिध्यानान्यपि कदाचिदुपकारिणीत्येतदुपदिष्टम् । (यो. प्र. ८ श्लो, ३१) ।

१विद्याप्रवादपूर्वस्य तृतीयप्राभृतादयम् ।

उद्धृतः कर्मघाताय श्रीवीरस्वामिसूरिभिः ॥८॥

२नासाग्रे प्रणवं शून्यमनाहतमिति त्रयम् ।

ध्यायन् गुणाष्टकं लब्ध्वा ज्ञानमाप्नोति निर्मलम् ॥९॥

शङ्खकुन्दशशाङ्काभांस्त्रीनमून् ध्यायतः सदा ।

समग्रविषयज्ञानप्रागल्भ्यं जायते सदा^३ ॥१०॥

द्विपार्श्वप्रणवद्वन्द्वं प्रान्तयोर्मायया वृतम् ।

सोऽहं मध्ये विमूर्धानं अहंकारं^४ विचिन्तयेत्^५ ॥११॥

६कामधेनुमिवाचिन्त्यफलसम्पादनक्षमाम् ।

अनवद्यां जपेद् विद्यां गणभृद्वदनोद्गताम् ॥१२॥

७षट्कोणेऽप्रतिचक्रे फडिति प्रत्येकमक्षरम् ।

सव्ये न्यसेत् विचक्राय स्वाहा बाह्येऽपसव्यतः ॥१३॥

भूतान्तं बिन्दुसंयुक्तं तन्मध्ये न्यस्य चिन्तयेत् ।

नमो जिणाणमित्याद्यैरौपूर्वैर्वेष्टयेद् बहिः ॥१४॥

८कर्मदावहुताशस्य प्रशान्तिमेव वारिदम् ।

गुरुपदेशाद् विज्ञाय सिद्धचक्रं विचिन्तयेत् ॥१५॥

१ सन्तुल्यतां यो. प्र. ८ (श्लो. ७४.) ।

२ ओम् हं, अष्टौ गुणा अणिमादयः । यो. ३ ०नृणाम्० ।

४ यो. ०अहम्लीकारं० ।

५ हौं ॐ ॐ सः अहम्ली हं ॐ ॐ हौं ।

६ विद्या च ॐ जोगे मगे तच्चे भूए भविस्से अन्ते पक्खे जिणपार्श्वे स्वाहा ।

७ ॐ नमो जिणाणं, ॐ नमो ओहिजिणाणं, ॐ नमो परमोहिजिणाणं, ॐ नमो सव्वोसहि-
जिणाणं, ॐ नमो अणंतोहिजिणाणं, ॐ नमो कुट्टबुद्धीणं, ॐ नमो बीयबुद्धीणं, ॐ नमो पदानुसारीणं,
ॐ नमो संभिन्नसोयाणं, ॐ नमो उज्जुमईणं, ॐ नमो विउलमईणं, ॐ नमो दसपुव्वीणं, ॐ नमो
चउदसपुव्वीणं, ॐ नमो अट्टमहानित्तकुसलाणं, ॐ नमो विउव्वणइड्ढिपत्ताणं, ॐ नमो विज्जाहराणं,
ॐ नमो चारणाणं, ॐ नमो पणसमणाणं, ॐ नमो आगासगामीणं, ॐ ज्झौं ज्सौं श्रीहीधृत्तिकीर्ति-
बुद्धिलक्ष्मी स्वाहा, इतिपदैर्वलयं पूरयेत् । पञ्चनमस्कारेण पञ्चांगुलीन्यस्तेन सकलीक्रियते । तद्यथा—ॐ नमो
अरिहन्ताणं ह्रीं स्वाहा अंगुष्ठे, ॐ नमो सिद्धाणं ह्रीं स्वाहा तर्जन्याम्, ॐ नमो आयरियाणं ह्रूं स्वाहा
मध्यमायाम्, ॐ नमो उवज्जायाणं ह्रूं स्वाहा अनामिकायाम्, ॐ नमो लोए सव्वसाहूणं ह्रौं स्वाहा
कनिष्ठायाम्, एवं वारत्रयमंगुलीषु विन्यस्य मस्तकस्योपरि पूर्वदक्षिणापरोत्तरेषु भागेषु विन्यस्य जपं कुर्यात् ॥

८ यो. ०जन्मदाव० ।

चीर्णैरपि चिरं कालं तपोभिरमलैः सदा ।

कथञ्चित् प्राप्यते पुग्भिः महामन्त्रो महागुणः ॥१६॥

अनाख्येयमसाधूनां साधूनामपि यत्नतः ।

कथ्यमेकान्तदेशेषु मन्त्रस्यास्य स्वरूपकम् ॥१७॥

मूलमन्त्रोऽपि व्याख्येयो महागुणविवर्द्धनः ।

येन विज्ञातमात्रेण सम्पदः सर्वतोमुखाः ॥१८॥

त्रिभुवनस्वामिनीं विद्यां त्रिभुवनस्वामितास्पदम् ।

विद्यां स्मरत हे धीरा ! यद्यक्षयसुखेच्छवः ॥१९॥

लक्षकस्य प्रजापेन प्रसूनैर्जातिसम्भवैः ।

दशांशहोमतो याति सिद्धिं विद्या प्रसाधिता ॥२०॥

इत्याचार्यश्रीभद्रगुप्तविरचितायामनुभवसिद्धमन्त्रद्वारिंशिकायां सर्वकर्मकर-
मन्त्राष्टकवर्णनो नाम प्रथमोऽधिकारः ॥१॥

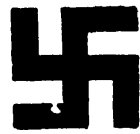

अथातः संप्रवक्ष्यामि वक्ष्याकर्षणमुत्तमम् ।
 येन विज्ञातमात्रेण सुखं सम्पद्यतेऽद्भुतम् ॥१॥
 प्रणवं मायया युक्तं कमलायुतमेव च ।
 कलिकुण्डमुद्यतं चापि स्वामिने वशमानय ॥२॥
 पुनरानय स्वाहेति मन्त्रः पार्श्वजिनाग्रतः ।
 त्रिरात्रं साधितः पुष्पैर्युतेन वशंवदः ॥३॥
 प्रणवं कामबीजं च मायाबीजं तथैव च ।
 अधोरेफयुतं शून्यं वाग्बीजेन प्रसंयुतम् ॥४॥
 मायावाग्भवबीजेन सहिता मायया पुनः ।
 शून्यं रेफेण संयुक्तं सपासं सविसर्गकम् ॥५॥
 श्रीभपराजितदेव्या मन्त्रोऽयमपराजितः ।
 लक्षत्रितयजापेन सिद्धिं याति सुनिश्चितम् ॥६॥
 पिण्डाकृष्टिं फलाकृष्टिं द्रव्याकृष्टिं च कामिताम् ।
 वस्त्राद्याकर्षणं सर्वं कुरुते नात्र संशयः ॥७॥
 वक्ष्या भवन्ति कामिन्यो भ्रश्यत्परिहिताम्बराः ।
 आजन्म दास्यभावं च भजन्ते नात्र संशयः ॥८॥
 यद् यत् कामयते सर्वं तत् सद्यस्तस्य जायते ।
 मन्त्रराजप्रसादेन फलमस्य न संशयः ॥९॥
 प्रणवं पार्श्वनाथाय मायाबीजं तथैव च ।
 एवं लक्षप्रजापेन मन्त्रोऽयं सिद्धयति स्फुटम् ॥१०॥
 नारीणां पुरुषाणां च भूपतीनां विशेषतः ।
 आराध्यमानो यत्नेन दशाहेन वशङ्करः ॥११॥
 सहस्रमेकं यत्नेन दशाहं प्रतिवासरम् ।
 पदभ्रष्टो जपेद् यस्तु स सद्यो लभते पदम् ॥१२॥
 वाञ्छितानि च जन्तूनां फलान्यस्य प्रभावतः ।
 कल्पद्रोरिव जायन्ते नानारूपाणि नित्यशः ॥१३॥
 पाशं पाशयुतं शून्यं विषघ्नं मङ्गलं तथा ।
 कल्याणं चेति मन्त्रोऽयं पार्श्वयक्षाभिधानतः ॥१४॥
 देयोऽयं भक्तियुक्ताय सूर्यचन्द्रोपरागयोः ।
 दीपोत्सवेऽथवा मन्त्रो रहस्सु गुरुपूजया ॥१५॥

तेनापि भक्तियुक्तेन शुद्धचित्तेन सन्ततम् ।
 मायामद्वियुक्तेन क्रोधलोभमदोज्झिना ॥१६॥
 सत्यवाक्यप्रधानेन गुरुपादोपसर्पिणा ।
 एकभक्तोषितेनैव ब्रह्मचर्यविधायिना ॥१७॥
 सहस्रैकस्य जापेन षण्मासान् प्रतिवासरम् ।
 श्रीमत्पार्श्वजिनेन्द्रस्य गुरुपूजापुरस्सरम् ॥१८॥
 ध्यातव्यः सुधिया नित्यं मन्त्रोऽयममरार्चितः ।
 सिद्धिं याति ततस्तस्य महासत्त्वशिरोमणेः ॥१९॥
 यस्यायं सिद्धयते मन्त्रो वशे तस्य वसुन्धरा ।
 सद्यो भवति मर्त्यस्य कर्तव्यो नात्र संशयः ॥२०॥
 द्वारे तस्य च गर्जन्ति शैलोल्लङ्घशरीरकाः ।
 मुहुःस्रवन्मदासारसिक्तोर्वीका मतङ्गजाः ॥२१॥
 हेषन्ति च हया द्वारे वेगनिर्जितवायवः ।
 प्रणतिं यान्ति पादानां तस्य स्फारितभक्तिकम् ॥२२॥
 पादपीठलुठन्मूर्धमुकुटकोटितटोत्कटाः ।
 पादयोस्तस्य भूपाला लुठन्ति बहुमानिनः ॥२३॥
 न दोषान् कोऽपि गृह्णाति गुणान् सर्वोऽपि भाषते ।
 तस्य सौभाग्ययुक्तस्य यस्य तुष्टो जिनेश्वरः ॥२४॥
 ब्रह्मत्रिलोककमलामूलबीजत्रयं ततः ।
 कलिकुण्डलदण्डाय ह्रींनमश्चाक्षराणि च ॥२५॥
 रविसङ्ख्यसहस्राणि प्रसूनैर्जातिसम्भवैः ।
 पयःपूर्णालुकामध्ये जापं कुर्याज्जिनाग्रतः ॥२६॥
 सिद्धिं याति ततो मन्त्रः पार्श्वस्यैव प्रभावतः ।
 कामदो मोक्षदश्चापि भक्तिभाजां शरीरिणाम् ॥२७॥
 रक्षोयक्षोरगव्याघ्रव्यालानलगरादयः ।
 नापकर्तुमलं तेभ्यो ये चास्य शरणं गताः ॥२८॥
 वह्निव्याधिपयोनिधिहरिकरिफणिचौरसंयुगादीनाम् ।
 भयमखिलमस्य संस्मृतिमात्रादपि देहिनां व्रजति ॥२९॥
 व्यन्तरविषविषमज्वरदुष्टग्रहशाकिनीप्रमुखदोषाः ।
 दूरे तस्य वहन्ते यस्यायं भवति हृदयस्थः ॥३०॥

सद्यो दासति कर्षितकरालकरवालकोपितः शत्रुः ।
 श्रीपार्श्वमन्त्रमुच्चैरुच्चरतां देहिनां नित्यम् ॥३१॥
 निन्दूविरूपवन्ध्याशल्यवतीदुर्भगादिदोषत्वम् ।
 भजते न जातु जिनवरवरमन्त्रपरायणो जन्तुः ॥३२॥
 कीर्तिः कमला रमणी राज्यं सौभाग्यमाशु सौख्यानि ।
 मन्त्रे लब्धेऽप्यस्मिन्निह जन्तोः सपदि जायन्ते ॥३३॥
 तममररमणीनिकरः सरभसमभिसरति दिव्यविश्रान्तम् ।
 लावण्यसिन्धुगाहनगिरिराजे यस्य चैतसी वृत्तिः ॥३४॥
 येषां परमब्रह्मणि मन्त्रेऽस्मिन् परममानसी प्रीतिः ।
 ते हन्त साभिलाषं वीक्ष्यन्ते मुक्तिकामिन्या ॥३५॥
 वाग्भवं कामबीजं च सान्तं षान्तेन संयुतम् ।
 ओंकारेण युतं चापि मन्त्रं वश्यकरं परम् ॥३६॥
 ऊर्ध्वाधोरेफसंयुक्तं षष्ठमस्वरभूषितम् ।
 नादबिन्दुकलाक्रान्तं साध्यनामैकगर्भितम् ॥३७॥
 तद्बाह्येऽष्टदलं पञ्च कर्णिकाकोटिभूषितम् ।
 तत्र चो पार्श्वनाथाय स्वाहेति पदमुल्लिखेत् ॥३८॥
 स्वराः षोडश तद्बाह्ये हरहरेति ततो बहिः ।
 कादिक्षान्तपदैः पश्चात् पूरयेत् सततं बहिः ॥३९॥
 मायाबीजेन तद्बाह्ये रेखात्रितयवेष्टितम् ।
 भूर्जपत्रे लिखेच्चक्रं सर्वसम्पत्तिकारणम् ॥४०॥
 कर्पूरागरुकस्तूरीकुङ्कुमादिसुगन्धिभिः ।
 विलेख्यं जातिलेखिन्या शुभलग्ने शुभे दिने ॥४१॥
 वेष्ट्यं कुमारसूत्रेण बाहौ बद्धं च देहिनाम् ।
 सौभाग्यभाग्यमुख्यानि सौख्यानि कुरुते क्षणात् ॥४२॥
 प्रणवं माययोपेतं कमलालङ्कृतसन्निधिम् ।
 मायायुक्तं पुनर्नामगर्भितं कमलोदरे ॥४३॥
 बहिरष्टदलाक्रान्तमायाबीजसमन्वितम् ।
 बहिः प्रणवर्हीकारपार्श्वनाथाय हीं नमः ॥४४॥
 लिखित्वा पूजयेद् भूर्जे सुगन्धद्रव्ययोगतः ।
 कन्यासूत्रेण संवेष्ट्य धारणीयं करादिषु ॥४५॥

भूतादिदोषविद्रावं योषिता गर्भसम्भधम् ।
 सौभाग्यादिगुणाश्चैवं यन्त्रमेतत् करोत्यहो ॥४६॥
 प्रणवं परमं तत्त्वं मायाबीजविराजितम् ।
 परमेष्ठ्यादिपदं चैव ह्रींकारं च नमः पदम् ॥४७॥
 त्रिसन्ध्यं विजने भूत्वा जातिपुष्पैरथोत्तमैः ।
 अष्टोत्तरशतं जाप्यमस्य सर्वार्थसिद्धये ॥४८॥
 इत्याकृष्टिं च वश्यादौ मन्त्राष्टकमुदीरितम् ।
 श्रुताम्भोधिमवगाह्य रत्नोच्चयमिवोज्ज्वलम् ॥४९॥
 इत्याचार्यश्रीभद्रगुप्तविरचितायामनुभवसिद्धमन्त्रद्वारिंशिकायां वश्या-
 कृष्ट्यादिकर्मकर मन्त्राष्टकवर्णनो नाम द्वितीयोऽधिकारः ॥



अथातः सम्प्रवक्ष्यामि स्तम्भस्तोभादिकं विधिम् ।
 येन विज्ञातमात्रेण जगतोऽज्ययता भवेत् ॥१॥
 ऊर्ध्वाधोरेफयुक्तस्य कलाबिन्दुयुतस्य च ।
 नामसङ्गर्भितस्याद्योऽष्टन्यवर्णस्य संलिखेत् ॥२॥
 परमेष्ठिपञ्चबाह्ये सम्यग्ज्ञानं च दर्शनम् ।
 चारित्रं च ततः स्वाहा ॐपूर्वकं ततः स्वरान् ॥३॥
 वर्गाष्टकं च पत्रेषु सन्धौ तत्त्वाक्षराणि च ।
 मायास्वप्नं कुशरुद्धं रेखात्रितयवेष्टितरू ॥४॥
 भूमण्डलं ततः कृत्वा यथाविधि समन्वितम् ।
 पट्टे पटे च भूर्जे वा द्रव्यैश्च गुलिकादिभिः ॥५॥
 शराः शक्रादिदेवानामपि स्तम्भनमुत्तमम् ।
 भाराक्रान्तमिदं चक्रं कुरुते नात्र संशयः ॥६॥
 एतदेव पटे भूर्जे कर्परे मृतकर्पटे ।
 विलिख्य निखनेत् प्रेतवने सम्पुटमध्यगम् ॥७॥
 तिलतुषराजीलवर्णैर्मिश्रीकृत्यैकविंशतिदिनानि ।
 अष्टदलमुभयकालं जपतान्मन्त्रेण सिद्धसक्तेन ॥८॥
 उच्चाटनमारणविद्वेषणगुरुमोहमुख्यकर्माणि ।
 मन ईप्सितानि जनानां जायन्ते सद्गुरुप्रसादात् ॥९॥
 ॐ उल्कामुखी अलामाक्षी विद्युज्जिह्वे ! महाबले ! ।
 अमुकस्य ज्वरं सद्य आनयानय रौद्धयकः ॥१०॥
 द्विर्दह द्विः पचोच्चार्यं स्वाहान्ते च ततः क्षिपेत् ।
 एकभक्तं ततः कृत्वा सिद्धयेऽष्टशतं जपेत् ॥११॥
 कृष्णाष्टम्यां चतुर्दश्यां चिताङ्गारसुरा ददेत् ।
 खरीमूत्रेण संकुथ्यारलुकद्रुमसम्पुटे ॥१२॥
 विलिख्येदं महामन्त्रमेकान्ते सम्पुटं क्षिपेत् ।
 अष्टोत्तरशतं चास्य प्रजपेत् प्रतिवासरम् ॥१३॥
 यन्नाम लिखितं गर्भे जप्तं चोद्यमपूर्वकम् ।
 तस्यानयेज्ज्वरं सद्यः सप्तास्यमपि तत्क्षणात् ॥१४॥
 न तच्छक्रोऽपि संहर्तुं शक्नोति ज्वरमुत्थितम् ।
 तदक्षराली नो यावत् क्षालिता पयसा किल ॥१५॥

ॐ अमृतोद्भवे ! देवि ! वर्षय वर्षयामृतम् ।
 इत्यादिकेन मन्त्रेण वह्निस्तोभो विधीयते ॥१६॥
 वंकारमध्यसंस्थानं मायाबीजेनवेष्टितम् ।
 अमुकं देवि ! कुरुकुले ! कुरु स्वाहेति चोच्चरेत् ॥१७॥
 दुष्टकुष्ठं क्षयं याति क्षीरनीरं पचायते ।
 पुष्पमालायते व्यालः कुन्ताग्रं कुसुमायते ॥१८॥
 नीरपूरायते वह्निर्गरलं च सुधायते ।
 माघामासायते ग्रीष्मो रविः शीतकरायते ॥१९॥
 नित्यैकद्वित्रिसम्भूतज्वरो याति परिक्षयम् ।
 कम्पस्वेदादिका दोषा गच्छन्ति प्रलयं क्षणात् ॥२०॥
 आह्नामात्रेण च क्षुद्रा वृश्चिकाद्यास्तनूमृतः ।
 दूरे व्रजन्ति विद्याया पतस्याः सुप्रभावतः ॥२१॥
 ॐ उच्चिष्ट पिशाचिनी देवी मही स्वाहेति कथ्यते ।
 उच्चिष्ट पिशाचिनी नामविद्या सर्वज्ञभापिता ॥२२॥
 मृन्मयी पुत्रिकां कृत्वा जरत्कषरसूर्पिकाम् ।
 एकान्ते स्थापयेत् तां च पूजयेच्च यथाविधि ॥२३॥
 त्रयोदश दिनान्युच्चैः पूजानैवेद्यपूर्वकम् ।
 उच्चिष्टोच्चिष्टवेलायां जपेद् वारांस्त्रयोदश ॥२४॥
 विकायैश्च प्रदातव्यं नैवेद्यं प्रतिवासरम् ।
 चतुर्दशेऽह्नि सम्प्राप्ते मध्ये कृष्णघटं क्षिपेत् ॥२५॥
 रक्तपुष्पैश्चसम्पूज्य पुत्रिकां तां च मृन्मयीम् ।
 यावता तेलपूरेण ब्रुडेत् तावत्प्रमाणकम् ॥२६॥
 कूपे सरसि नद्यां वा प्रवाहयेत् ततो घटम् ।
 सिद्धयत्येषा ततो विद्या महासत्वैकशालिनाम् ॥२७॥
 यद्येकदापि पुरुषाणां साधयतां स्वलितं भवेत् ।
 षण्मासान्ते ततो विद्यां पुनरेतां प्रजापयेत् ॥२८॥
 सिद्धा सती च जन्तूनां ददाति प्रतिवासरम् ।
 द्रम्मान् त्रयोदशैवैतान् पुनरन्यस्य नो वदेत् ॥२९॥
 परमागमसम्प्रोक्तं विश्वकम्पैकचेटकम् ।
 द्रम्माष्टकपदं सद्यः साधयेद्दुर्धैर्यसंयुतः ॥३०॥

ॐचल चल प्रचल [२] विश्वं कम्पय [२] च ।
 वेलात्रयं ठठ स्वाहा विश्वं कम्प कम्पेति च ॥३१॥
 श्रीपर्ण्या पट्टके मन्त्रं लिखित्वैनं महामतिः ।
 जातीपुष्पैस्ततो जापं पञ्चायुतप्रमाणकम् ॥३२॥
 दशांशेन च होतव्यं त्रिमधुरेण संयुतम् ।
 बदरप्रमाणगुटिकाभिर्महिषाक्ष च द्रुतम् ॥३३॥
 कृष्णाष्टम्यां निशामध्ये नवम्यां भास्करोदये ।
 अष्टोत्तरशतं रक्तपुष्पाणि प्रजपेत् ततः ॥३४॥
 चेटकप्रतिमां कृत्वा चिताङ्गारेण मण्डले ।
 हृदये साध्यनामं च लिखित्वा प्रजपेत् ततः ॥३५॥
 निर्धूमाङ्गारसम्पूर्णं घटमाघाय होमयेत् ।
 तान्येव पूर्वजप्तानि रक्तपुष्पाणि शक्तिमत् ॥३६॥
 विद्वेषोच्चाटनं सद्यः कुरुते देहिनामयम् ।
 कपिलाक्षचेटको ह्येवं जप्तः पठितसिद्धिदः ॥३७॥
 ॐ नमो भगवत्यादौ शिवचक्रे च मालिनि ! ।
 स्वाहापदं ततो देयं मन्त्रोऽयं लाभदो मतः ॥३८॥
 श्वेतार्कस्य च मूलेन बिम्बं पार्श्वजिनेशितुः ।
 विधाय च प्रतिष्ठाप्य मन्त्रेणानेन पूजयेत् ॥३९॥
 यद् यद् विचिन्त्यते कार्यं मनुजैरैहलोकिकम् ।
 तत् तत् सम्पद्यते सद्यो मन्त्रस्यास्य प्रभावतः ॥४०॥
 राजद्वारे व्यवहारे विवादे धान्य संग्रहे ।
 इत्येवमादिकार्येषु सर्वेष्वेनं विचिन्तयेत् ॥४१॥

इत्याचार्यश्रीभद्रगुप्तविरचितायामनुभवसिद्धमन्त्रद्वारिशािकायां
 स्तम्भस्तोभादिकमन्त्राष्टकवर्णनो नाम तृतीयोऽधिकारः ॥३॥



अथातः सम्प्रवक्ष्यामि शुभाशुभादिसूचकम् ।
 मन्त्राष्टकमिदं रम्यं सद्यः प्रत्ययकारकम् ॥१॥
 प्रणवं मायया युक्तं ल्वा ह्वा प लक्ष्मिकान्वितम् ।
 वायाशून्यावसानं च मन्त्रं मन्त्रविदो विदुः ॥२॥
 सहस्रदशकं जातिपुष्पैः पूर्वं प्रजप्य तु ।
 पश्चाद् दशांशहोमेन सिद्धिरस्य विधीयते ॥३॥
 कार्यकाले च सम्प्राप्तं विधायैकासनं तपः ।
 अष्टोत्तरशतं जप्त्वा स्वपेद् भूमौ व्रते स्थितः ॥४॥
 लाभालाभं भविष्यन्तं शुभाशुभं जयाजयम् ।
 जीवितं मरणं चैव सुभिक्षं क्षेममेव च ॥५॥
 वर्षावर्षं भयं भीतिवर्जितं सुखदासुखम् ।
 लगित्वा कर्णयोर्देवी सर्वमाख्याति निश्चितम् ॥६॥
 ॐ ह्रीं ल्वां ह्वां प लक्ष्मीं क्लीं क्ष्मीं च कुश्च हं स च ।
 स्वाहाकारं ततो देयं मन्त्रोऽयं मुनिभाषितः ॥७॥
 त्रयोदश सहस्राणि जातिपुष्पैश्च पूर्वतः ।
 जापोऽस्य हि विधातव्यो महासत्त्वैकशालिभिः ॥८॥
 तदनूत्तरसेवायां दशांशहोमतस्तथा ।
 मन्त्रोऽयं साध्यतां नेयः संयमारामगामिभिः ॥९॥
 विधिः पुनरयं चात्र मन्त्रस्यास्य प्रसाधने ।
 स्नात्वा विलिप्य सर्वाङ्गं सहशश्वेतवस्त्रभृत् ॥१०॥
 स्वयं चोपोषितो भूत्वा कन्याभोजनदायकः ।
 कुमारीगुरुपूज्यानां वस्त्रदानपुरःसरम् ॥११॥
 श्रीमदम्बिकादेव्या बिम्बमादाय सद्भुवि ।
 स्नानपूजादिकं कृत्वा तस्या एव पुरःस्थितः ॥१२॥
 विद्यामेतां महाभक्त्या संयताक्षो महामतिः ।
 दिनत्रयेण संसाध्य केवलीव भवेन्नरः ॥१३॥
 यत् परैश्चिन्तितं कार्यं स्वयं वा चिन्तितं भवेत् ।
 नष्टं वा निहितं चापि तच्चाज्ञातस्य नामकम् ॥१४॥
 अतीतं वर्तमानं वा भविष्यं वा यदर्थयेत् ।
 ज्ञातुं मन्त्री तर्कं सर्वं कथयत्येष कर्णयोः ॥१५॥

ॐ ह्रीं ल्वाहापलक्ष्मी व हंसः स्वाहा च विन्यसेत् ।
 विश्वोपकारिणीं विद्यामेतां तत्त्वविदो विदुः ॥१६॥
 सहस्रदशकं जातीपुष्पैः पूर्वं प्रजप्यते ।
 ह्यते तु दशांशेन पश्चात् विद्या प्रसिद्धयति ॥१७॥
 आज्ञामात्रेण संसिद्धा करोत्येषा शरीरिणाम् ।
 जङ्गमे स्थावरे चापि विषे वीर्यविनाशनम् ॥१८॥
 पतद् विद्यात्रयं भव्यजीवोपकृतिहेतवे ।
 मयागममहाम्भोधिमध्यादुद्धृत्य दर्शितम् ॥१९॥
 मिथ्यादृशां न दातव्यं दातव्यं सुदृशां पुनः ।
 दातव्यं योग्यजीवानामयोग्यानां न दापयेत् ॥२०॥
 षान्तं हकारसंयुक्तं लकारं सान्तसंयुतम् ।
 रेफस्वरकलाक्रान्तं विन्दूपेतं महाक्षरम् ॥२१॥
 इदमेवाक्षरं लक्षवारं रक्तप्रसूनकैः ।
 जाड्यं हरति जन्तूनां जप्तं सज्ज्ञानमुद्रया ॥२२॥
 जप्तं करोति जन्तूनां वश्याकृष्टिमहोदयम् ।
 इदमेवाक्षरं लक्षवारं रक्तप्रसूनकैः ॥२३॥
 गजा गोयोषितः श्रुद्रजन्तवो यान्ति वश्यताम् ।
 पतद्बीजप्रभावेन साधकानामसंशयम् ॥२४॥
 विद्वद्वादिमहेभानां स्तम्भकुम्भविदारणे ।
 पतदेव परं बीजं कण्ठीरवपदायते ॥२५॥
 ॐ ह्रीं देवि ! नमस्तुभ्यमम्भोरुहनिभानने ! ।
 नमन्नभश्चरीमूला(चूला)माणिक्यारुणितक्रमे ! ॥२६॥
 लक्षत्रयप्रजापेन जातीपुष्पैः प्रसिद्धयति ।
 सरस्वती महादेवी दिव्या कमलवासिनी ॥२७॥
 गद्यपद्यमयी वाणी गङ्गानीरानुरागिणी ।
 निर्याति सततं तस्माद् यस्य तुष्टा सरस्वती ॥२८॥
 बन्धे बोधेऽपि तेषां त्वविश्रान्तं जृम्भते मतिः ।
 येषामेषा महादेवी वरदीभूतमानसा ॥२९॥
 प्रबन्धसेतुबन्धेन रामस्येव पताकिनी ।
 तेषां प्रयाति सत्कीर्तिः पारं नीरपतेरपि ॥३०॥

ॐ वाग्बीजं च माया च कमलाकामवर्णकौ ।
 सतत्त्वमादिवर्णाश्च नमोऽन्ताः सर्ववेदिनाम् ॥३१॥
 एष लोके महामन्त्रः पञ्चानां परमेष्ठिनाम् ।
 त्रिभुवनस्वामिनी नाम पुण्यलभ्या महात्मभिः ॥३२॥
 लक्षजाप्यप्रदानेन दशांशेन च होमतः ।
 सिद्धिं याति महामन्त्रो गुरुसत्त्वैकशालिनाम् ॥३३॥
 मेघाकृष्टिं तटस्तम्भं प्रतिमाचालनं तथा ।
 करोत्येष मनुष्याणां मनोवाञ्छितसिद्धदः ॥३४॥
 राज्यवश्यं देववश्यं वश्यं च सुरयोषिताम् ।
 वश्याकर्षणदक्षोऽयं सर्ववश्यविधायकः ॥३५॥
 ॐ ह्रीं माययोपेतं पद्मा सतत्त्वकामदम् ।
 ह्रीं कलिकुण्डनाथाय सौं ह्रीं नम इत्यपि ॥३६॥
 श्रीकलिकुण्डदण्डस्य मूलमन्त्रोऽयमुत्तमः ।
 तपोभिरमलैर्लभ्योऽनुचीर्णैः पूर्वजन्मनि ॥३७॥
 श्रीमत्पार्श्वजिनस्याग्रे यन्त्रमाधाय सद्बिधि ।
 जातीपुष्पैर्जपेल्लक्षं मन्त्रमेनं दशांशतः ॥३८॥
 होमेन साधयेद् धीमान् सर्वकामफलप्रदम् ।
 भक्तिभाजां विशेषेण शुभाशुभनिरूपकम् ॥३९॥
 एकभुक्तोषितो भूत्वा यद्वा षण्मासकावधिः ।
 अष्टोत्तरशतं जाप्यं कुर्यादस्य दिने दिने ॥४०॥
 भवद्भूतभविष्यानि सुखदुःखानि देहिनाम् ।
 सैकत्रावस्थितो वेत्ति योजनानां शतैरपि ॥४१॥
 ब्रह्मचर्यभृतं पञ्च वर्षाणि ध्यायतः सतः ।
 सद्ग्रथानध्याननिष्ठस्य विकथारहितस्य च ॥४२॥
 पलं पलं सुवर्णस्य ददात्येष्वनुवासरम् ।
 व्यये तु तच्च कर्तव्यं न धर्तव्यं हि नान्तरे ॥४३॥
 धृतेन हीयते सिद्धिः सिद्धिर्बद्धेत तद्व्ययात् ।
 व्ययोऽत एव कर्तव्यः सत्पात्रादौ मनीषिभिः ॥४४॥
 ॐ शून्यद्वयं षष्ठस्वराद्यं बिन्दुसंयुतम् ।
 पुनः शून्यद्वयं होकादशस्वरसमन्वितम् ॥४५॥

सप्तवर्णादिमं मन्त्रं षष्ठस्वरविराजितम् ।
 विन्दूपेतं च ह्रीं ह्रूं फडिति वर्णविभूषितम् ॥४६॥
 सर्वकर्मकरं मन्त्रं श्रीमत्पार्श्वजिनेशितुः ।
 लक्षजापप्रदानेन साधयित्वा स्फुटं कुरु ॥४७॥
 राजद्वारे व्यवहारे च सभायां देशनाविधौ ।
 विद्वद्विवादवेलायां परविद्यान्तकर्मणि ॥४८॥
 वश्ये विद्वेषणे मोहे पापोच्चाटनकर्मणि ।
 तीर्थप्रभावनादौ च रुष्टानयनकर्मणि ॥४९॥
 एष एव महामन्त्रो महाकल्याणकारणम् ।
 सर्वदा सर्वकार्येषु स्मरणीयो मनीषिभिः ॥५०॥

इत्याचार्यश्रीभद्रगुप्तविरचितायामनुभवसिद्धमन्त्रद्वारिंशिकायां शुभाशुभादिनि-
 रूपणमन्त्राष्टकवर्णनो नाम चतुर्थोऽधिकारः ।

— ० —

अथातः सम्प्रवक्ष्यामि गुरुशिष्यशुभाशुभम् ।
 येन विज्ञातमात्रेण कल्याणं जायते द्वयोः ॥१॥
 गुरुणा ज्ञाततत्त्वेन सकलागमवेदिना ।
 शशाङ्कशान्तचित्तेन क्षमागुणविराजिना ॥२॥
 पूर्वमात्महितं ज्ञात्वा सूरिणा गुणभूरिणा ।
 शिष्यस्यापि हितं चिन्त्यं दातुकामेन किञ्चन ॥३॥
 सिद्धं साध्यं च विज्ञेयं सुसिद्धं शत्रुरूपिणम् ।
 मृत्युदं चैव निःशेषं मन्त्रं मन्त्रविदो विदुः ॥४॥
 सिद्धं सारफलं ज्ञेयं दातव्यं भक्तिशालिने ।
 साध्यं साध्यफलं चापि देयं तदपि सूरिणा ॥५॥
 स्वल्पफलं सुसिद्धं सुमन्त्रो यच्छति देहिनाम् ।
 सोऽपि कस्यापि दातव्यस्तद्धितस्य शरीरिणः ॥६॥
 शत्रुरूपा च शत्रुस्तु मृत्युदो मृत्युनामकः ।
 नैव कस्यापि दातव्यौ परलोकफलार्थिभिः ॥७॥
 अ-इ-उ-ए-ओ पञ्चैतान् स्वरान् कोष्ठकपञ्चके ।
 कादिकान् हान्तवर्णांश्च डढणाक्षरवर्जितान् ॥८॥
 वर्णक्रमेण संलिख्य मातृकाचक्रमुज्ज्वलम् ।
 योग्यायोग्यं ततो विद्यान्मन्त्रशिष्य द्वयोरपि ॥९॥

सिद्धं वा यदि वा साध्यं मन्त्रं प्राप्य दुरासदम् ।
 शिष्येणापि विधातव्या सद्गुरोर्भक्तिरीदृशी ॥१०॥
 भोजनं वस्त्रदानं च पात्रदानं तथैव च ।
 दानं सारसुवर्णस्य विधातव्यं मनीषिणा ॥११॥
 पादप्रक्षालनं चैव पृष्ठिसंवाहनं तथा ।
 स्वयमासनदानं च कर्तव्यं सद्गुरोरिह ॥१२॥
 दक्षो जितेन्द्रियो धीमान् कोपानलजलोपमः ।
 सत्यवादी विलोभश्च मायामदविवर्जितः ॥१३॥
 मानत्यागी दयायुक्तः परनारीसहोदरः ।
 जितेन्द्री गुरुभक्तश्च मन्त्रग्राही भवेन्नरः ॥१४॥
 सुलग्ने शोभने वारे तिथिनक्षत्रचन्द्रके ।
 मन्त्रादानं विधातव्यं गुरुपूजापुरःसरम् ॥१५॥
 दीपोत्सवे व्यतोपाते चन्द्रसूर्योपरागयोः ।
 विशेषेण विधातव्यं मन्त्रादानं यथाविधि ॥१६॥
 श्रुतसागरमालोड्य महारत्नसमा मया ।
 एते मन्त्राः समाख्याता योग्यानां हितकाम्यया ॥१७॥
 परीक्षितगुणानां तु भक्तियुक्तशरीरिणाम् ।
 श्रद्धावतां प्रदातव्याः सुखमिच्छुभिरात्मनः ॥१८॥
 मायाहङ्कारयुक्तेषु श्रद्धाहीनदुरात्मसु ।
 निर्गुणेषु च एतांस्तु मन्त्रान् दाता स्वदोषतः ॥१९॥
 सोऽनन्तं लप्स्यते सद्यः संसारं दुःखरूपिणम् ।
 अनन्तानि च दुःखानि शिष्यस्यापि प्रदास्यति ॥२०॥
 इति ज्ञात्वा प्रयत्नेन एकान्ते गुरुभक्तितः ।
 भक्तियुक्ताय शिष्याय दद्यान्मन्त्रमनुत्तरम् ॥२१॥
द्वारिशिकाया यः करिष्यति ।
 सद्भ्यस्तं सदा तस्य सर्वज्ञत्वं भविष्यति ॥२२॥
 इह लोकेऽपि दुःखानि द्वारिद्रव्याणि च दूरतः ।
 क्षयं तस्य प्रयास्यन्ति योऽमुष्मै भक्तिबन्धुरः ॥२३॥
 तस्मादेतां महामन्त्रद्वारिशिकां महामतिः ।
 अनाख्येयामयोग्यानां स्वयं नित्यं विभावयेत् ॥२४॥

इत्याचार्यश्रीभद्रगुप्तविरचितायामनुभवसिद्धमन्त्रसिद्धद्वारिशिकायांगुरुशिष्य
 शुभाशुमसंसूचको नाम पञ्चमोऽधिकारः समाप्तः ॥५॥



Goddess Shanti

“ शान्तिदेवतां शालग्रामां कमलासनां वनभुजां वरदात्मप्रयुक्तशक्तिप्रदाम् कृष्णकाम-
कमण्डलुवर्तिवन्वासकरां चेति । ”

सिवाणकरिकाश्याम

परिशिष्ट ३१
श्रीमानदेवसूरिसूत्रितः
श्रीलघुशान्तिस्तवः ।

शान्तिं शान्तिनिशान्तं शान्तं शान्ताशिवं नमस्कृत्य ।
स्तोतुः शान्तिनिमित्तं मन्त्रपदैः शान्तये स्तौमि ॥१॥

श्रीधर्मप्रमोदगणिविरचिता वृत्तिः ।

नमः श्रीशान्तये ।

श्रीमन्तं बोधिदं नत्वा सदर्थज्ञानसिद्धये । कुर्वे शान्तिस्तवस्याहं व्याख्यामेतां सुबोधदाम् ॥१॥
तत्र पूर्वमस्य स्तवस्योत्पत्तिः कथ्यते । सा चेयम्—
सूरयो मानदेवाख्या बृहद्गच्छे पुराऽभवन् । एकदाऽस्थुश्चतुर्मासीं नङ्गूलनगरे च ते ॥१॥
तस्मिन्नेव हि समये शाकम्भरीपुरेऽजनि । श्रीसङ्घः शाकिनीमार्युप्रद्रवेणादितो भृशम् ॥२॥
महातिशयसूरीन्द्रमानदेवान्तिक्ते तदा । सङ्घेनालोच्य मनुजाः प्रेषितास्तत्र ते गताः ॥३॥
विहिता तैः पुरः सूरेर्विज्ञतिर्विनयान्वितैः । सङ्घोपद्रवविच्छिन्नैः कृत्वाऽयं प्रेषितः स्तवः ॥४॥
पद्मासुजयाविजयापराजितादेवताप्तसान्निध्यैः । श्रीमानदेवगुरुभिर्जनमतोत्साहकरणपरैः ॥५॥
पठनादेतस्य ततः स्वयमन्यसमीपतश्च वा श्रवणात् ।
एतदभिमन्त्रिताम्भोविन्दुवितरणाद् गता मारी ॥६॥
श्रीसङ्घस्य समुत्पन्ना शान्तिर्दुःखविनाशिनी । एतत्स्तवोत्पत्तिरियमेवं गुरुमुखाच्छ्रुता ॥७॥
उक्तं च तद्गच्छीयश्रीगुरुणामवदाते—

न मूलनाम नगरे कृतमेघकालैः शाकम्भरीपुरसमागतसङ्घवाचा ।

शान्तिस्तवः प्रबलमारिभयापहारी यैर्निर्ममे सुविहितक्रममार्गदीपैः ॥

अथ सूत्रं प्रारभ्यते—‘शान्तिं शान्तिनिशान्तं.’ व्याख्या—

ओमितिनिश्चितवचसे नमो नमो भगवतेऽर्हते पूजाम् ।
 शान्तिजिनाय जयवते यशस्विने स्वामिने दमिनाम् ॥२॥
 सकलातिशेषकमहा सम्पत्तिसमन्विताय शस्याय ।
 त्रैलोक्यपूजिताय च नमो नमः शान्तिदेवाय ॥३॥

अहं शान्ति-षोडशजिनं नमस्कृत्य तमेव शान्तिजिनं प्रति स्तौमि । किमर्थम् ? दुःखदुरितोपसर्गनिवृत्तिहेतवे । कैः कृत्वा ? 'मन्त्रपदैः' विभक्त्यान्तमन्त्राक्षरसमूहैः । कथम्भूतं शान्तिम् ? 'शान्तिनिशान्तम्' शान्तेः-दुःखाद्युपशमहेतुभूतायाः कपायोदयापगमनलक्षणया वा भद्रस्य वा निशान्तं-गृहम् । 'धामागारं निशान्तम्' इत्यभिधानचिन्तामणौ प्रोक्तत्वात् । पुनः कथम्भूतम् ? 'शान्तम्' उपशमसहितम्, रागद्वेषरहितं जितेन्द्रियं वेत्यर्थः । 'दान्तः शान्तो जितेन्द्रियः' इत्यभिधानचिन्तामणिः । पुनः 'शान्ताशिवम्' शान्तानि-उपशमं नीतानि अशिवानि-अरिष्टानि येन, अथवा शान्तानि उपशमं प्राप्तानि अशिवानि यस्मात् स शान्ताशिवः तम् । यतो यस्मिन् गर्भे समुत्पन्ने पूर्वोत्पन्ना मारिः शान्ता शिवं च जातमतः शान्ताशिवः तम् । पुनः०? 'शान्तिनिमित्तम्' शान्तेः-दुःखदुरितोपसर्गादिनिवृत्तिहेतोः निमित्तंकारणम् । कस्य ? 'स्तोतुः' स्तुतिकर्तुर्नरस्येत्यर्थः ।

अत्र स्तवे महाकविप्रणीतत्वात् मन्त्राक्षरत्वाच्च पुनरुक्तादयो दोषा न चिन्तनीयाः । यदुक्तम्—

वक्ता हर्षभरादिभिराक्षिप्तमनाः स्तुवन् तथा निन्दन् ।

यत् पदमसकृद् ब्रूयात् तत् पुनरुक्तं न दोषाय ॥ १ ॥

'अर्हं पूजायाम्, योगत्वेऽपीति केचन' अर्हति-योग्यो भवतीत्यर्हन् तस्मै । कां प्रति ? 'पूजाम्' चतुःषष्ठीन्द्रादिकृताचार्याम् । पुनः०? जयो-रागाद्यान्तरशत्रुत्वम् क्षयकरणोत्थः सोऽस्त्यस्येति जयवान् तस्मै सर्वत्राजेयाय । पुनः० कथम्भूताय ? यशः-प्रशस्ता श्लाघा अस्त्यस्येति यशस्वी तस्मै । पुनः० ? 'स्वामिने' नायकाय । केषाम् ? दमोऽस्त्येषां दमिनः तेषां दमयुक्तानां-योगीन्द्राणाम् ।

द्वितीयागाथात आरभ्य चतुर्दशीं गाथां यावत् षष्ठीं गाथां विहाय पृथक् पृथक् प्रतिगाथां मन्त्राक्षराणि सन्ति । ताः ओमित्यादि भगवत्यन्तास्त्रयोदश गाथा व्याख्याय प्रान्ते सम्पूर्णां मन्त्रो दर्शयिष्यते । च-पुनः शान्तिदेवाय नमो नमः पूर्वोक्तोक्तिः । कथम्भूताय शान्तिदेवाय ? सकलाः-सम्पूर्णाः अतिशेषकाः-अतिशयाश्चतुस्त्रिंशत् । चत्वारः सहजाः, एकादश कर्मक्षयजाः, एकोनविंशतिर्देवकृताः । अतिशयग्रहणात् पञ्चत्रिंशद् वचनातिशया अपि । तल्लक्षणैव महती सम्पत्तिः-ऋद्धिस्तया समन्वितो युक्तः तस्मै

सर्वाभरसुसमूहस्वामिकसम्पूजिताय न जिताय ।
 भुवनजनपालनोद्यततमाय सततं नमस्तस्मै ॥४॥
 सर्वदुरितौघनाशनकराय सर्वाशिवप्रशमनाय ।
 दुष्टग्रहभूतपिशाचशाकिनीनां प्रमथनाय ॥५॥ युग्मम् ॥
 यस्येतिनाममन्त्रप्रधानवाक्योपयोगकृततोषा ।
 विजया कुरुते जनहितमिति च नुता ! नमत तं शान्तिम् ॥६॥

पुनः०? 'शस्याय' प्रशंसायोग्याय । पुनः० कथं० ? त्रयाणां लोकानां समाहाराखिलोकी-
 जगत्त्रयी तत्र भवाः त्रैलोक्याः-सुरमनुजदनुजाः । अथवा त्रिलोक्येव त्रैलोक्यं तैस्तेन
 वा पूजितः, तस्मै ॥३॥

तस्मै शान्तये सततं-सदा नमः नमस्कारो भवतु । कथम्भूताय तस्मै ? सर्वेषां-
 समस्तानां अमराणां-देवानां सह समूहैर्वर्तते ससमूहाः-समूहसहिताः ये स्वामिन एव
 स्वामिकाः, स्वार्थे कः । अर्थाच्छक्रादयश्चतुःपष्टिरिन्द्रास्तैः सम्-सम्यक् प्रकारेण त्रिकर-
 णशुद्ध्या पूजितः तस्मै । केपुचिदादर्शेषु 'सर्वाभरसुसमूह' इति पाठो दृश्यते, तत्रैवं व्या-
 ख्येयम्-अमराणां सुसमूहाः शोभनसमुदायाः, सर्वे येऽभरसुसमूहाः सर्वाभरसुसमूहाः
 तेषां स्वामिकास्तैः सम्पूजितस्तस्मै । पुनः० कथं०? 'न जिताय' कैरपि न परि०भूताय ।
 पुनः०? भुवनस्य जनाः भुवनजनास्तेषां पालने अतिशयेन उद्यत-उद्यततमस्तस्मै ॥४॥

पुनः कथं०? सर्वाणि सर्वेषां वा यानि दुरितानि-पापानि दुष्कृतं दुरितं पापम्
 इत्यभिधानचिन्तामणिः । तेषां ओघः-समूहस्तस्य नाशनं-विनाशनं कुरुत इति
 सर्वदुरितौघनाशनकरस्तस्मै । पुनः० ? सर्वाणि सर्वेषां वा यानि अशिवानि-अरिष्टानि
 प्रशमयति-निवर्तयति सर्वाशिवप्रशमनस्तस्मै । पुनः कथं०? प्रमथनातीतिप्रमथनस्तस्मै ।
 कासाम् ? दुष्टाः-क्रूराश्च अथवा गोचरेऽशुभफलप्रदाश्च ते ग्रहाश्च भूताश्च पिशा-
 चाश्च शाकिन्यश्च दुष्टग्रहभूतपिशाचशाकिन्यः, तासां पीडानिवाणकत्वात् भगवच्छ्रीशान्ति-
 नाम्नि स्मृते आसां पीडा विलीयन्त इति भावः । चतुर्षु पदेषु भूतपिशाचौ द्वितीय-
 प्रथमनिकायान्तर्वर्तिनौ व्यन्तरविशेषौ ज्ञेयौ ॥५॥

भो जनता ! जनानां समूहः तं शान्ति-षोडशं जिनं नमत-प्रह्वीभवत । यत्तदोर्नि-
 त्याभिसम्बन्धात् तमिति कम् ? यस्य श्रीशान्तिनाथस्य इत्यमुना पूर्वोक्तप्रकारेण नामैव
 मन्त्रः तेन प्रधानं यद् वाक्यं-वचः तस्य उपयोग-उच्चारणरूपः स्मरणरूपो वा तेन
 कृतः तोषो-मनसि सन्तोषो यथा सा नाममन्त्रप्रधानवाक्योपयोगकृततोषा इदृशी सती
 विजयते शत्रून्, विजयते वा शत्रूणामस्या इति विजया-विजया नाम्नी देवी, इति-
 वक्ष्यमाणप्रकारेण । जनानां हितं जनहितं कुरुते 'इति च नुता नमत तं शान्तिम्'

भवतु नमस्ते भगवति ! विजये ! सुजये ! परापरैरजिते ! ।

अपराजिते ! जगत्यां जयतीति जयावहे ! भवति ! ॥७॥

सर्वस्यापि च संघस्य भद्रकल्याणमङ्गलप्रददे ! ।

साधूनां च सदा शिवसुतुष्टिपुष्टिप्रदे ! जीयाः ॥८॥

इत्यपि कुत्रचित् पाठो दृश्यते तत्र नमत तं इति पदद्वयोतः कर्तृपदं ग्राह्यम् । भो भव्याः ! शेषं पूर्ववत् । इति नुता अत्रे वक्ष्यमाणप्रकारेण स्तुता ॥६॥

भगोऽस्त्यास्या भगवती तस्यामन्त्रणे हे भगवति ! हे समग्रैश्वर्यादियुक्ते ! । विजयोऽस्त्यास्या विजया तस्या आमन्त्रणे हे विजये !—हे अन्येषां निन्दाकारिणां पराभवरहिते ! । सुष्ठु-शोभनो जयोऽस्त्यस्याः सुजया तस्या आमन्त्रणे । 'विजये ! सुजये !' इत्यत्राभ्रादित्वाद् अप्रत्यये हे विजयवति ! हे सुजयवति ! 'हे अजिते !' न जिता अजिता तस्या आमन्त्रणे । कैः ? पराः—प्रधाना अपरे—अन्यसुराः, अथवा परे—अन्ये, अपरा असहमानाः शत्रवस्तैः हेऽपराजिते !—न पराजिता-भग्ना कस्यापि पुरत इत्यपराजिता तस्या आमन्त्रणम् 'जितो भग्नः पराजितः' इत्यभिधानचिन्तामणिः । क्व ? जगत्याम्—पृथिव्याम् । अथवा जगत्यां—लोके त्रैलोक्यामिति पूर्वोक्तप्रकारवर्णिते । अपि हे जयावहे ! जयमावहति समन्तात् प्रापयत्यान् जयकारित्वात् जयावहा तस्या आमन्त्रणे । हे विजये ! भवति ! । त्वम् । भवच्छब्दस्त्रीलिङ्गसम्बोधनरूपम् । या ईदृशी 'जयति' सर्वोत्कर्षेण वर्तते । तस्मै 'ते' तुभ्यम् नमस्कारो भवत्वित्यर्थः ॥

इत्यनेन चतस्रोऽपि देव्यो विजया जया अजिता अपराजिताख्या दर्शिताः ॥७॥

हे 'भद्रकल्याणमङ्गलप्रददे' ! भद्राणि च कल्याणानि च मङ्गलानि च भद्रकल्याणमङ्गलानि—सुखक्षेमपापोपशान्तिरूपाणि । अथवा—भद्रं-श्रेष्ठम्, कल्यं-नीरुक् तं अणन्ति आह्वयन्ति भद्रकल्याणानि एवं विधानि यानि मङ्गलानि श्रेयांसि । यदनेकार्थकोषः—

'भद्रं तु मङ्गले । मुस्तकश्रेष्ठयोः साधौ काञ्चने करणान्तरे ।'

तानि प्रकर्षेण ददते या सा भद्रकल्याणमङ्गलप्रददा । तस्या आमन्त्रणम् । 'दद दाने' इति धातोः प्रयोगः । कस्य ? 'सर्वस्यापि च सङ्घस्य' समस्तस्य चतुर्विधस्यापि सङ्घस्य । चकारात् ध्यातुरेस सङ्घस्य । हे 'सदा शिवसुतुष्टिपुष्टिप्रदे !' सदा-सर्वदा शिवं च तुष्टिश्च पुष्टिश्च शिवसुतुष्टिपुष्टयः निरुपद्रवता चित्तसन्तोष धर्मार्थकामवृद्धयः ताः प्रकर्षेण ददातीति शिवसुतुष्टिपुष्टिप्रदा । अथवा न शिवसुतुष्टिपुष्टयः अशिवसुतुष्टिपुष्टयः ताः प्रद्यति-खण्डयति या सा अशिवसुतुष्टिपुष्टिप्रदा । तस्याः आमन्त्रणम् । केषाम् ? उत्तमक्षमादिभिः तपोविशेषैर्भावित्वात्मानः साध्नोति, अथवा सम्यग्दर्शनादिभिः साधयन्ति

भव्यानां कृतसिद्धे ! निर्वृतिनिर्वाणजननि ! सत्त्वानाम् ।
 अभयप्रदाननिरते ! नमोऽस्तु स्वस्तिप्रदे ! तुभ्यम् ॥९॥
 भक्तानां जन्तूनां शुभावहे ! नित्यमुद्यते ! देवि ! ।
 सम्यग्दृष्टीनां धृतिरतिमतिबुद्धिप्रदानाय ॥१०॥
 जिनशासननिरतानां शान्तिनतानां च जगति जनतानाम् ।
 श्रीसम्पत्कीर्तियशो वर्धनि ! जयदेवि ! विजयस्व ॥११॥ युगम् ।

मोक्षमार्गमिति साधवः-मुनयः, उभयलोकफलं साधयन्ति वा साधवो, धर्मशीला तेषां चकारात् अन्येषां एवंविधपूर्वोक्तवर्णने हे विजये ! त्वं 'जीयाः' जययुक्ता भूयाः ॥८॥

कृता सिद्धिः-सर्वकार्येषु विघ्नक्षयलक्षणा यया सा तस्याः आमन्त्रणम् । हे 'निर्वृति निर्वाण जननि !' निर्वृत्तिः-निर्वाणं-सांसारिकं सुखं यद् हेमचन्द्रः-'स्यादथो शर्म निर्वृतः' निर्वाण-आत्यन्तिकं सुखंमोक्षः ततो द्वन्द्वः, निर्वृतिनिर्वाणे जनयति-उत्पादयति । अथवा उत्पादनहेतोर्निर्वृतिनिर्वाणयोर्जननी-माता तस्याः आमन्त्रणम् । 'माताम्वा जननी' इत्यभिधानचिन्तामणिः । केषाम् ? भव्यानाम्-आसन्नसिद्धिगतीनाम् । हे 'अभयप्रदान-निरते !' अभयस्य-निर्भयस्य प्रदाने-वितरणे निरता-सावधाना तस्याः आमन्त्रणम् । केषाम् ? सत्त्वानाम्-प्राणिनाम् । हे 'स्वस्तिप्रदे !' स्वस्ति-अविनाशम् प्रदत्ते या सा तस्या आमन्त्रणम् ! तुभ्यं नमोऽस्तु ॥९॥

अत्र गाथायुग्मेन सम्बन्धः ।

हे शुभावहे ! शुभं-कल्याणं आवहति-समन्तात् प्रापयति या सा तस्या आमन्त्र-णम् । केषाम् ? 'भक्तानां जन्तूनाम्' भक्तिमतां प्राणिनाम्, हे देवि ! हे विजये ! हे नित्यमुद्यते !-हे सदा सावधाने ! किमर्थम् ? 'धृतिरतिमतिबुद्धिप्रदानाय' धृतिश्च रतिश्च मतिश्च बुद्धिश्च धृतिरतिमतिबुद्धयः-सन्तोष-चित्ताभिरता शास्त्रोत्था तात्कालिक्यः तासां प्रति दर्शनीया ।

“मतिः अप्राप्तविषया बुद्धिः साम्प्रतदर्शिनी । अतीतार्था स्मृतिर्ज्ञेया प्रज्ञा कालत्रयात्मिका ॥”

इत्युक्तेः । समासः पूर्ववदेवेति । केषाम् ? सम्यक्-सत्या दृष्टिः-दर्शनम्, येषां ते, तेषाम् ॥१०॥

हे 'श्रीसम्पत्कीर्तियशोवर्धनि !' श्रीः-शोभा लक्ष्मीर्वा, सम्पत् नवधा ऋद्धिः, कीर्तिः-श्लाघा ख्यातिर्वा, यशः सर्वदिग्गामिप्रसिद्धिविशेषः, ततो द्वन्द्वः । तानि वर्द्ध-यति तस्याः आमन्त्रणम्' क्व ? 'जगति' लोके । केषाम् ? जन्तूनाम् । कथम्भूतानाम् ? जिनशासने ये निरता-निश्चला भक्तिमत्वात् तेषाम् । पुनः केषाम् ? शान्ति नताः शान्तिनताः तेषां चकारात् सेवास्वसेवाकारिणाम् । क्वचित् 'जनतानाम्' इति पाठः ।

सलिलानलविषविषधरदुष्टग्रहराजरोगरणभयतः ।

राक्षसरिपुगणमारीचौरेतिश्वापदादिभ्यः ॥१२॥

अथ रक्ष रक्ष सुशिवं कुरु कुरु शान्तिं च कुरु कुरु सदेति ।

तुष्टिं कुरु कुरु पुष्टिं कुरु कुरु स्वस्तिं च कुरु कुरु त्वम् ॥१३॥ युग्मम् ॥

भगवति ! गुणवति ! शिवशान्तिपुष्टिपुष्टिस्वस्तीह कुरु कुरु जनानाम् ।

ओ मिति नमो नमो हौं हीं ह्रौं ह्रः यः क्षः हीं फद् फद् स्वाहा ॥१४॥

जयेन युक्ता देवी जयदेवी तस्या आमन्त्रणम् । त्वं विजयस्व-सर्वोत्कर्षेण इत्यर्थः । जया सूचितेत्यनेन ॥११॥

अत्रापि गाथायुग्मेन सम्बन्धः ।

अथ इत्यानन्तर्ये । त्वं रक्ष रक्ष-पाहि पाहि, मन्त्राक्षरत्वाद् द्विरुच्चारोऽत्र । कस्मात् ?, केभ्यः ? सलिलं-जलम्, समुद्रादि, अनलः-अर्थाद् उत्पातदावानलादिरूपो वह्निः, विषं-जङ्गमस्थावरभेदाद् द्विधा, विषधरः-सर्पः, दुष्टा ग्रहगोचरेऽशुभाः ग्रहाः, रोगेषु राजा राजरोगः-क्षयरोगः, राजदन्तादिवत् अमाद्यन्तस्य परन्वम् । अथवा राजानोऽन्यायिनः, रोगाः कुष्ठज्वरादयः, रणः-सङ्ग्रामः ततो द्वन्द्वः तेषां भयम्, तस्माद् । राक्षसाः-व्यन्तरविशेषाः, रिपुगणाः-वैरिसमूहाः, मारी-मरकोपद्रवः ।

अत्र मात्राहानिभयान्मारीशब्द ईकारान्तः, न त्विकारान्तः ।

‘मारी चण्ड्यां जनक्षये’ इति हैमानेकार्थं (श्लो० ४५३) पाठात् । चौराः-तस्कराः, ‘इङ् गतो’ इयन्ते-आभिः अयनानि वा ‘स्त्रियां क्तिः’ (अ० ५ पा० ३ सू० ९१) इति ईतयः । ताः सप्तविधाः अतिवृष्ट्यादयः । श्वापदाः-व्याघ्रसिंहगन्धगजादयः, आदिशब्दात् भूतवैतालशाकिन्यादयः ततो द्वन्द्वः तेभ्यः ॥१२॥

सुशिवं-शोभनं कल्याणम् पुण्यसम्बन्धि, च पुनः, स्वस्ति-सङ्घाय अविनाशित्वम् चिरस्थायित्वम्, कुरु कुरु इति भावः । प्रयत्नोच्चारमन्तरेण क्वचित् संयोगपूर्वस्य गुरोरपि लघुत्वम् । तथा ‘कुरु कुरु स्वस्ति’ इत्यत्रापि मात्रा गणभङ्गप्रसङ्गभयात्, यदुक्तम्-तव यापह्नियो मम हीरभूत् () । इत्यादि दर्शनात् । अन्ये त्वाहुः-‘कुरु कुरु स्वस्ति’ मौले पाठे अव्ययं सम्भाव्यते । अत्र तु इकारान्तः शब्द पव । अन्यत्रापि ‘स्वस्तये’ इति पददर्शनात् ॥१३॥

हे भगवति ! हे गुणवति ! गुणाः औदार्यधैर्यगाम्भीर्यादयः सन्त्यस्या इति गुणवती तस्याः आमन्त्रणम् । इह जगति सङ्घे वा जनानां-लोकानां शिवशान्तिपुष्टिपुष्टिस्वस्ति कुरु कुरु । पञ्चानामपि पदानां पूर्वोक्तोऽर्थो वाच्यः, ततो द्वन्द्वः । स्वस्ती तीङन्तः शब्दोऽत्र ।

एवं यन्नामाक्षरपुरस्सरं संस्तुता जया देवी ।

कुरुते शान्तिं नमतां नमो नमः शान्तये तस्मै ॥१५॥

इति पूर्वसूरिदर्शितमन्त्रपदविदर्भितः स्तवः शान्तेः ।

सलिलादिभयविनाशी शान्त्यादिकरश्च भक्तिमताम् ॥१६॥

इदानीं मन्त्राक्षरैः श्रीजयादेवीं स्तवीत्याचार्य श्रीमानदेवः ।

ओमिति परमज्योतिःस्वरूपिण्यै तुभ्यं नमो नमः

तथा 'ॐ नमो ह्रीं ह्रीं ह्रूं ह्रः यः क्षः ह्रीं फट् फट् स्वाहा' इति मन्त्रस्वरूपिण्यै तुभ्यं नमः ॥ १४ ॥

अथ विसङ्कलितानि मन्त्रपदान्येकीकृत्य लिख्यते सम्पूर्णो मन्त्रः—

“ॐ नमो भगवते अर्हते शान्तिनाथस्वामिने (१)

सकलातिशेषकमहासम्पत्तिसमन्विताय त्रैलोक्यपूजिताय नमो नमः शान्ति देवाय (२)

सर्वामरसुसमूहस्वामिकसम्पूजिताय भुवनजनपालनोद्यताय (३) सर्वदुरित-
विनाशनाय सर्वाशिवप्रशमनाय दुष्टग्रहभूतपिशाचशाकिनीनां प्रमथनाय (४)

नमो भगवति ! जये ! विजये ! अजिते ! जयन्ति ! जयावहे ! (५) सर्वसङ्घस्य
भद्रकल्याणमङ्गलप्रददे ! साधूनां श्रीशान्तिपुष्टिपुष्टिदे ! स्वस्तिदे ! (६)

भव्यानां सिद्धिवृद्धिनिर्वृतिनिर्वाणजननि ! सत्त्वानामभयप्रदाननिरते ! (७)

भक्तानां शुभावहे सम्यग्दृष्टीनां धृतिरतिमतिबुद्धिप्रदानोद्यते ! जिनशासनरतानां
श्रीसंपत्कीर्तियशोवर्द्धनि ! (९)

रोगजलज्वलनविषविषधरदुष्टज्वरव्यन्तरराक्षसरिपुमारिचौरेतिश्वापदोपसर्गादिभयेभ्यः

रक्ष रक्ष शिवं कुरु कुरु शान्तिं कुरु कुरु तुष्टिं कुरु कुरु पुष्टिं कुरु कुरु (११)

ॐ नमो नमः ह्रीं ह्रीं ह्रूं ह्रः यः क्षः यः क्षः ह्रीं फट् स्वाहा ॥”

अस्य मन्त्रस्य जापात् तथा अन्याभ्यर्णार्कणनात् सर्वाण्यरिष्टानि सर्वा विपद् विली-
यन्ते, सर्वाः सम्पदः सम्पद्यन्ते ।

तस्मै शान्तये षोडशार्हते नमो नमः, तस्मै कस्मै ? 'एवं' अमुना पूर्वोक्तप्रकारेण
यस्य नामाक्षरपुरस्सरं-शान्तिनाथनामोच्चारणपूर्वकं यथा स्यात् तथा, 'संस्तुता' सम्यक्
प्रकारेण गुणवर्णनमाहान्म्यादिना कीर्तिता सती जया देवी 'नमतां' प्रह्वीभवतां मनु-
ष्याणां शान्तिं कुरुते ॥१५॥

अत्र गाथायुग्मेन सम्बन्धः ।

शान्तेर्जिनस्य स्तवः-स्तोत्रं 'भक्तिमतां' भक्तियुक्तानां जीवानां 'सलिलादिभय-
विनाशी' सलिलादीनां-समुद्रादीनां भयस्य-बुडनादेर्विनाशी । आदिशद्वात् सलिलानल-

यश्चैनं पठति सदा शृणोति भावयति वा यथायोगम् ।

स हि शान्तिपदं यायात् सूरिः श्रीमानदेवश्च ॥ १७॥ युगम् ॥

विषविषधरेतिगाथोक्तानां पदानां भयस्यापि । च पुनः 'शान्त्यादिकरो भवतु शान्तिग्रहणात् शिव-स्वस्ति-तुष्टि-पुष्टीनामपि ग्रहणम् । आदिग्रहणात् ऋद्धिसौभाग्यादीनां ग्रहणम् ।

पूर्वं बहुव्रीहिः ततः तत्पुरुषः । कथम्भूतः स्तवः ? 'इति' अमुना प्रकारेण 'पूर्व-सूरिभिः'-पूर्वाचार्यैः यानि दर्शितानि मन्त्रपदानि-मन्त्राक्षराणि तैः विदर्भितः-गुम्फितः रचित इत्यर्थः ॥१६॥

पुनर्यो नर एनं स्तवं 'सदा पठति' उद्घोषणेन 'शृणोति' अन्यसकाशाद्वा, अथवा 'भावयति' चित्तेनैव ध्यायति, योगं अनतिक्रम्य योगं प्रति वा शक्तिमनतिक्रम्य कार्यमुद्दिश्य स नरः हि-निश्चितम् पदम्—स्थानं दुःखादि निवृत्तित्वम् । अथवा सर्वोपद्रवदुरिताद्यपगमैः अर्थात् मुक्तिः तल्लक्षणं पदं यायात्-लभेत, च-पुनः श्रीमानदेव-सूरिरपि इत्यनेन स्तवविदर्भकेण निजं नाम दर्शितम् । 'शिवशान्तिपदं यायात्' केचिद् एवं पठन्ति-तत्र शिवशान्त्योः पूर्वोक्तार्थयोः पदं यायात् इत्यर्थः ॥१७॥

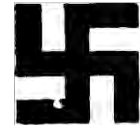
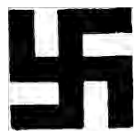



Yaksha Brahmashanti

ब्रह्मशांति नाम्ना प्रोक्तं शान्तिस्तुतव्यं ।
शान्तिस्तुतव्यं शान्तिस्तुतव्यं शान्तिस्तुतव्यं ।
शान्तिस्तुतव्यं शान्तिस्तुतव्यं शान्तिस्तुतव्यं ।
शान्तिस्तुतव्यं शान्तिस्तुतव्यं शान्तिस्तुतव्यं ।
शान्तिस्तुतव्यं शान्तिस्तुतव्यं शान्तिस्तुतव्यं ।

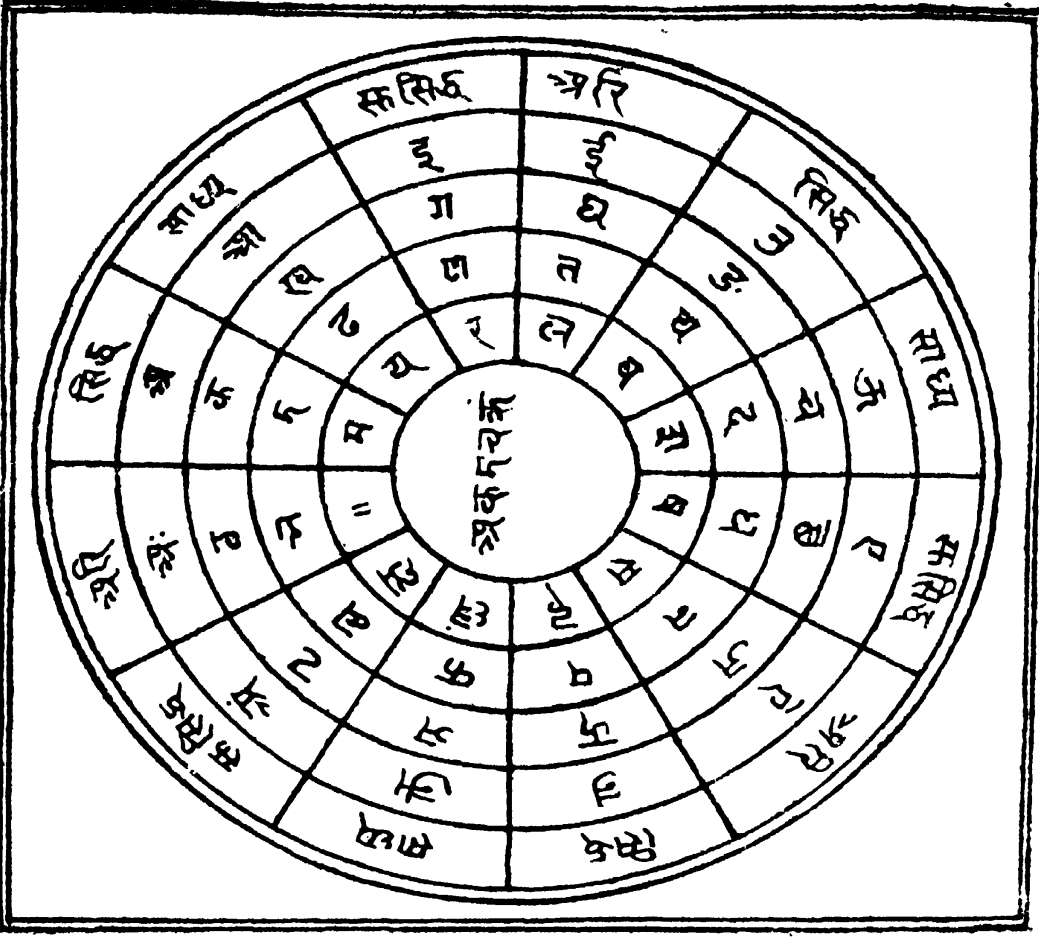

Fig. 2

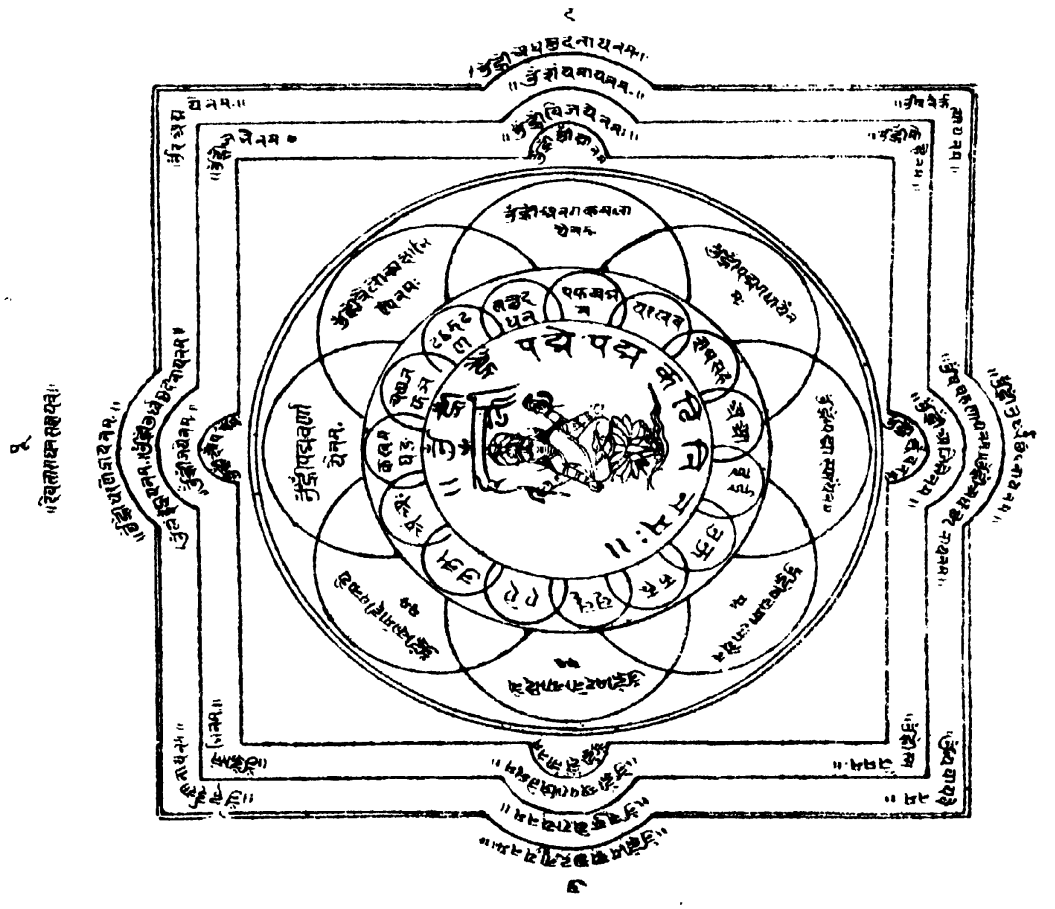

Fig. 1

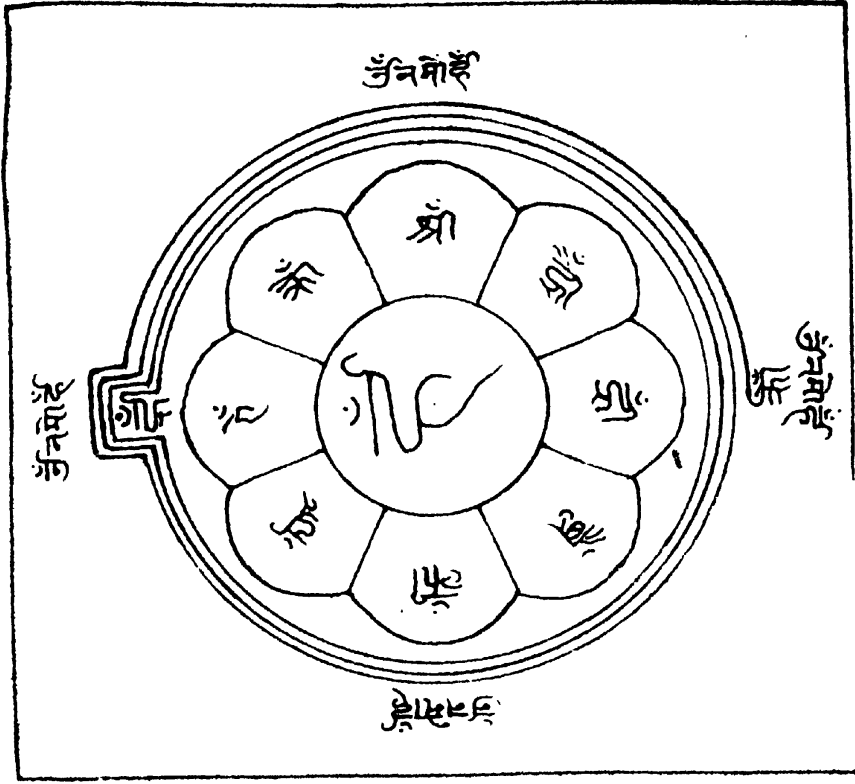

Fig. 4

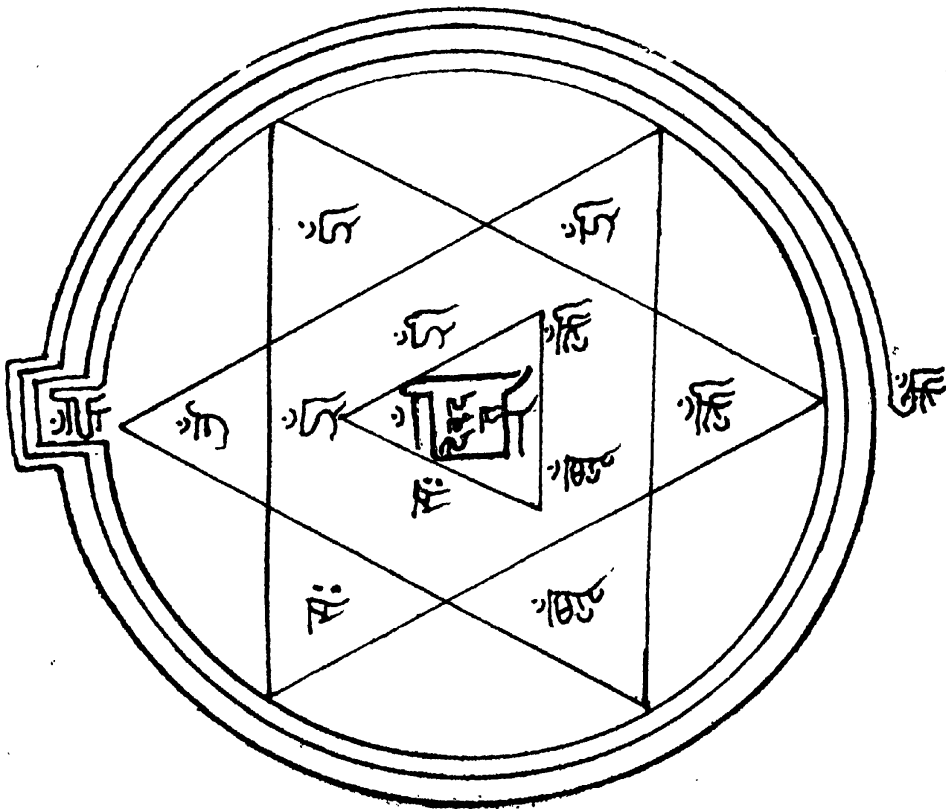

Fig. 3

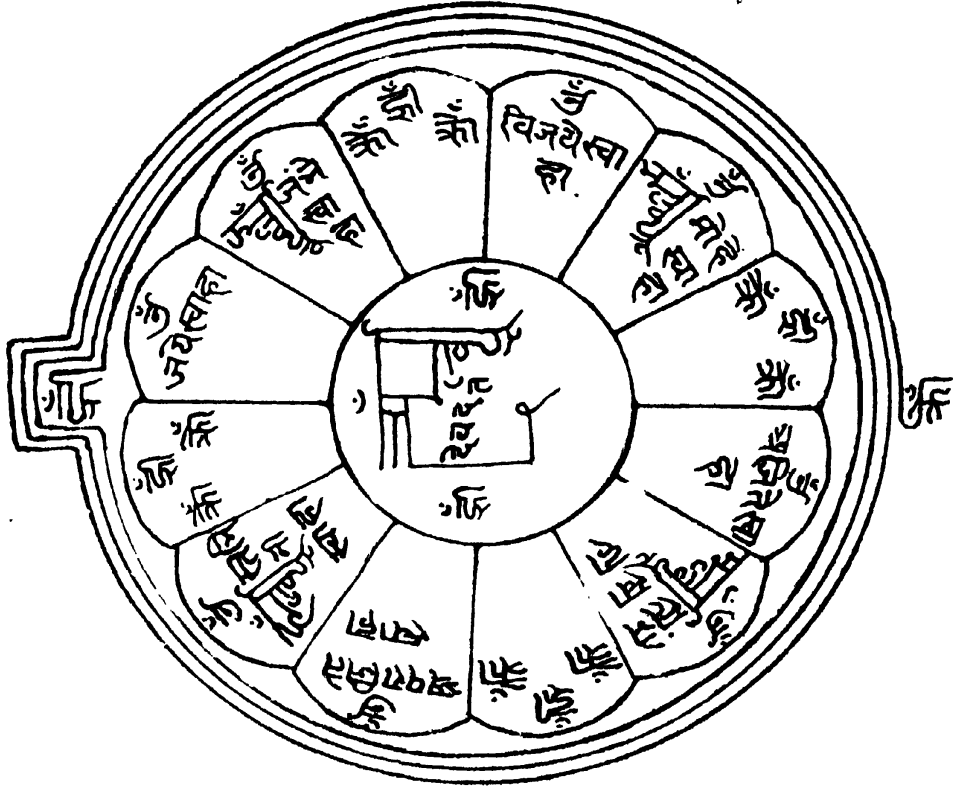

Fig. 6

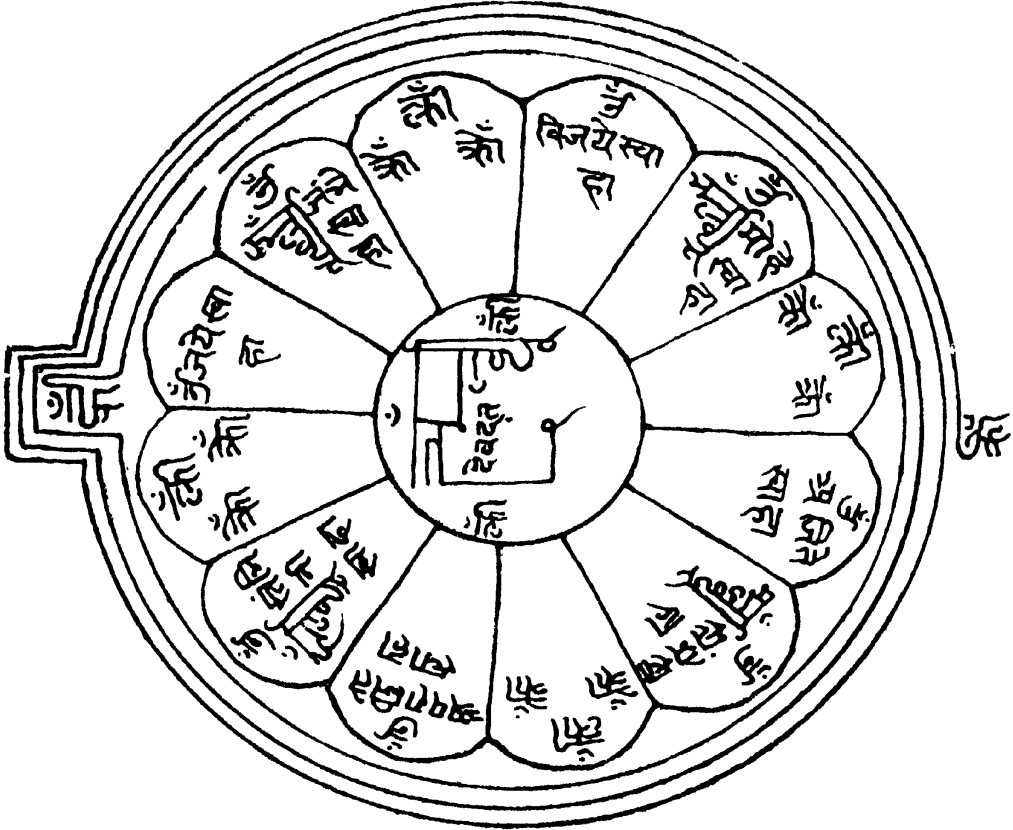

Fig. 5

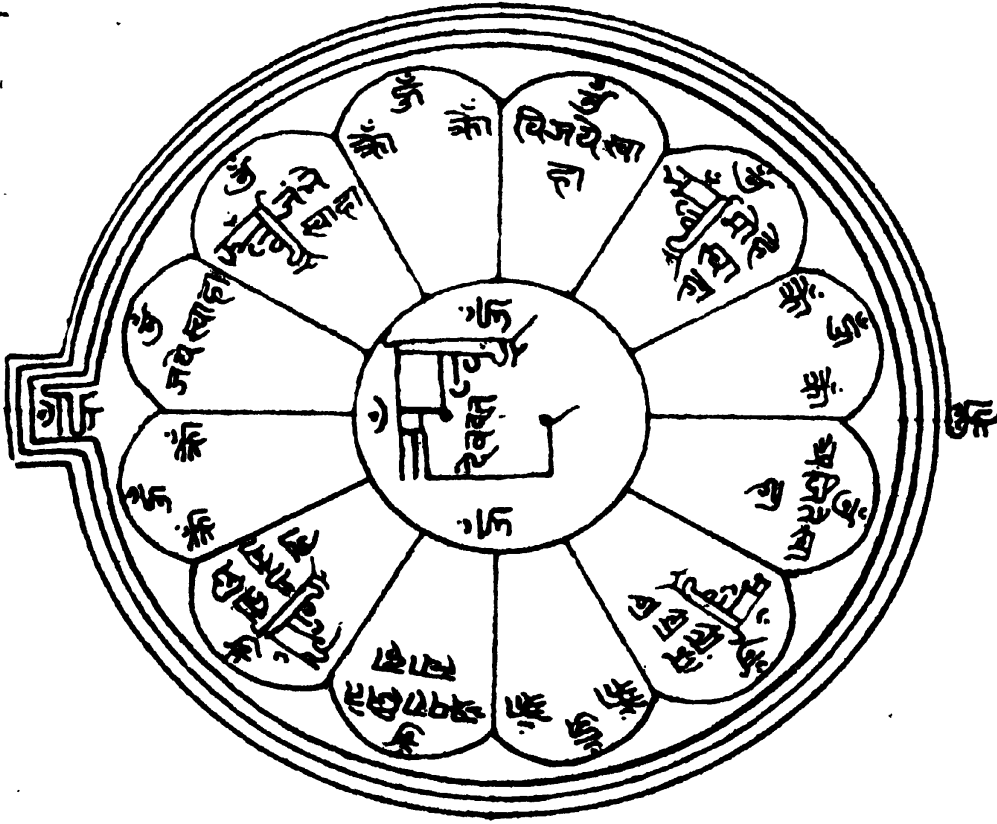

Fig. 7

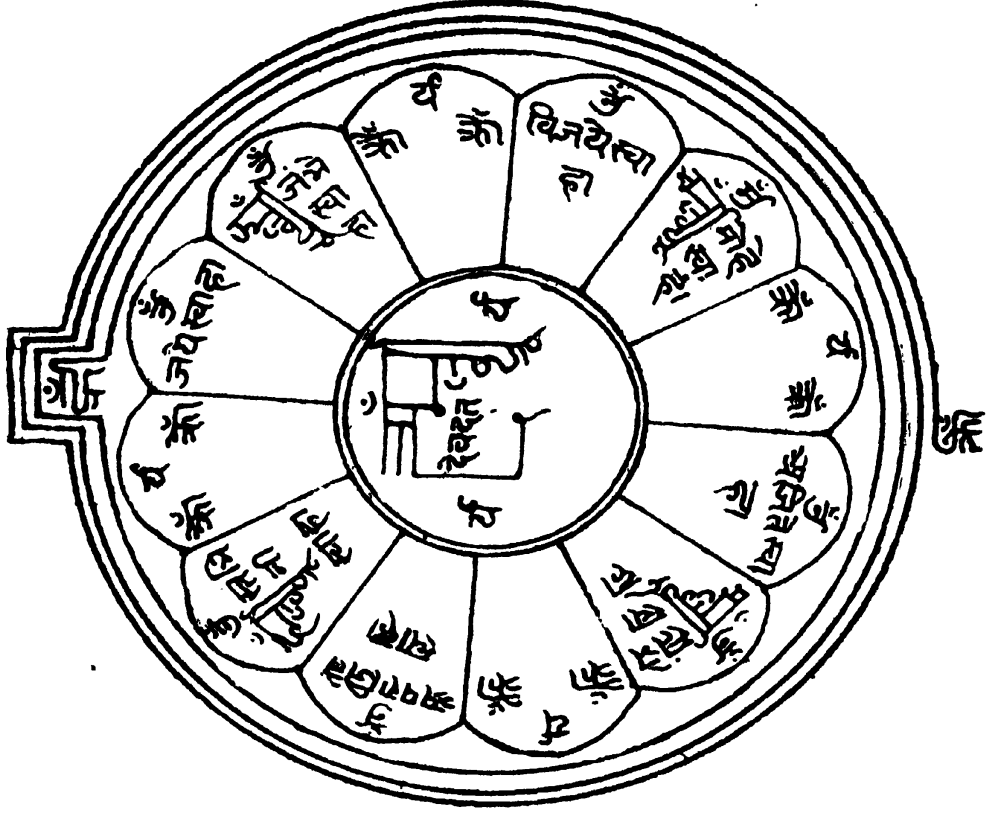

Fig. 8

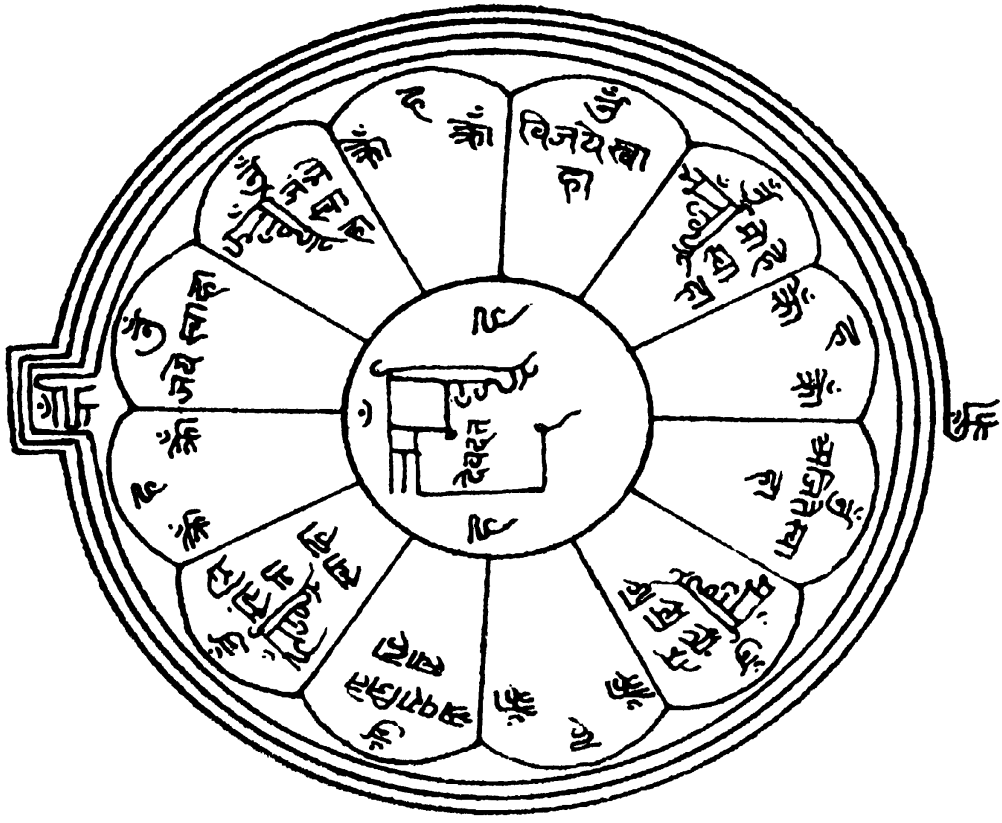

Fig. 10

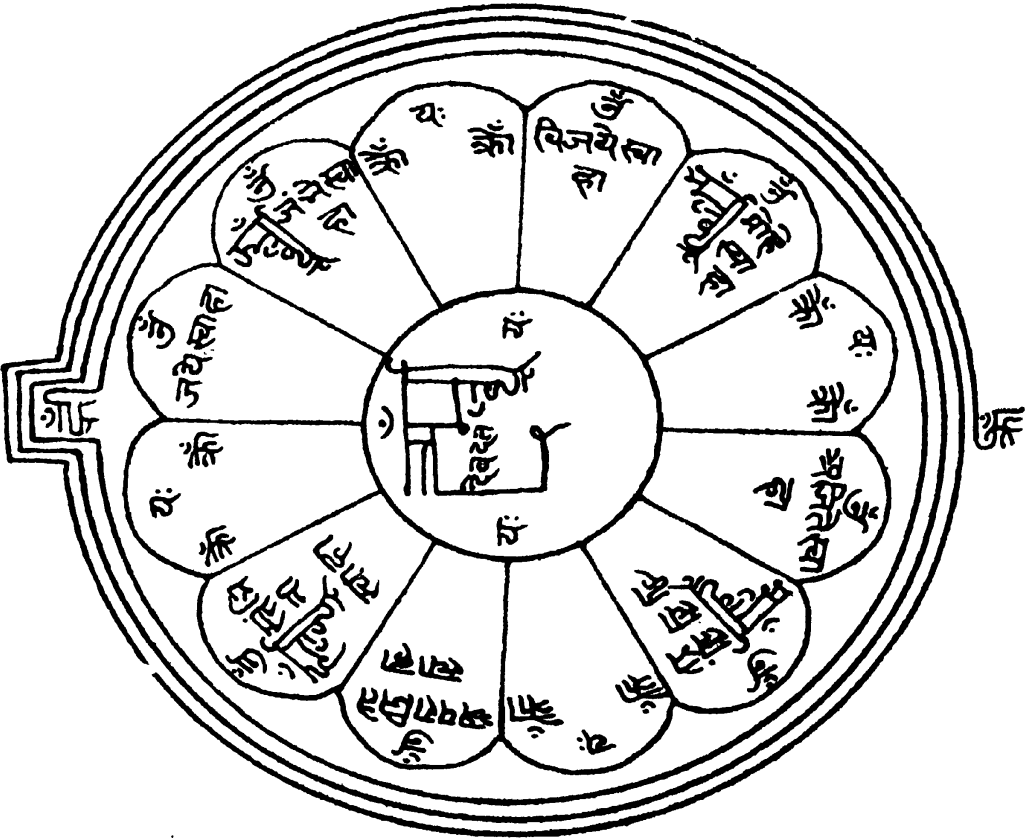

Fig. 9

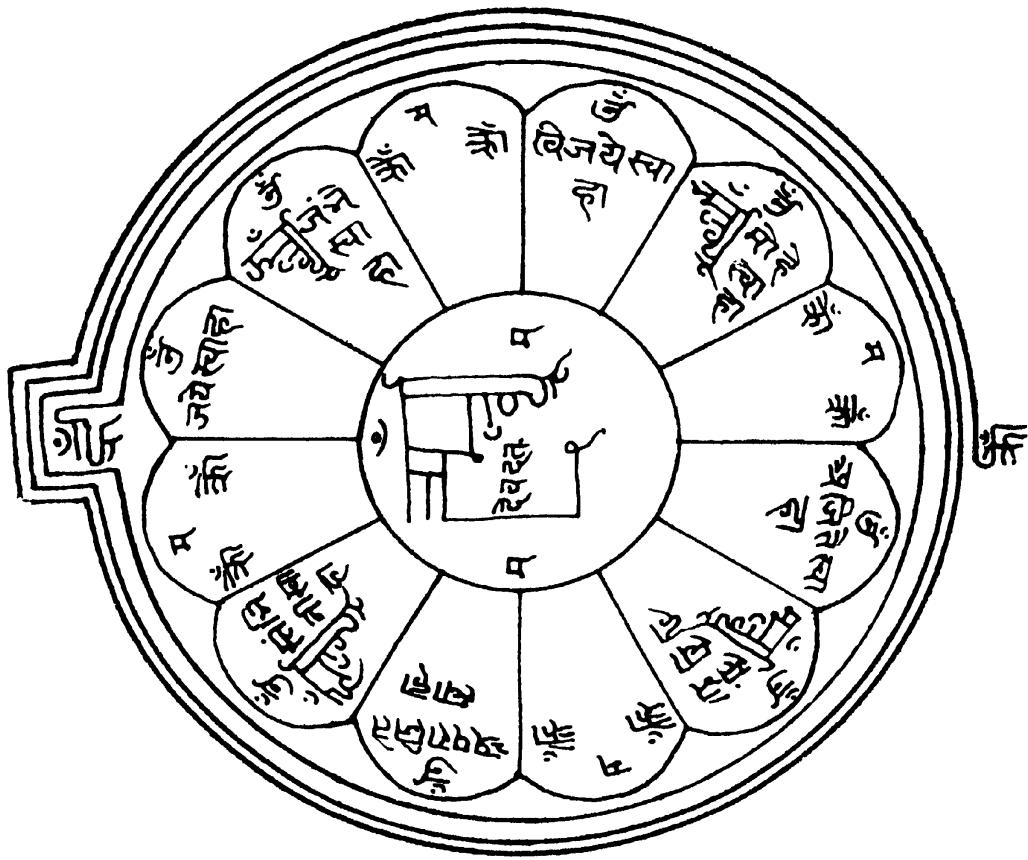

Fig. 12



Fig. 11

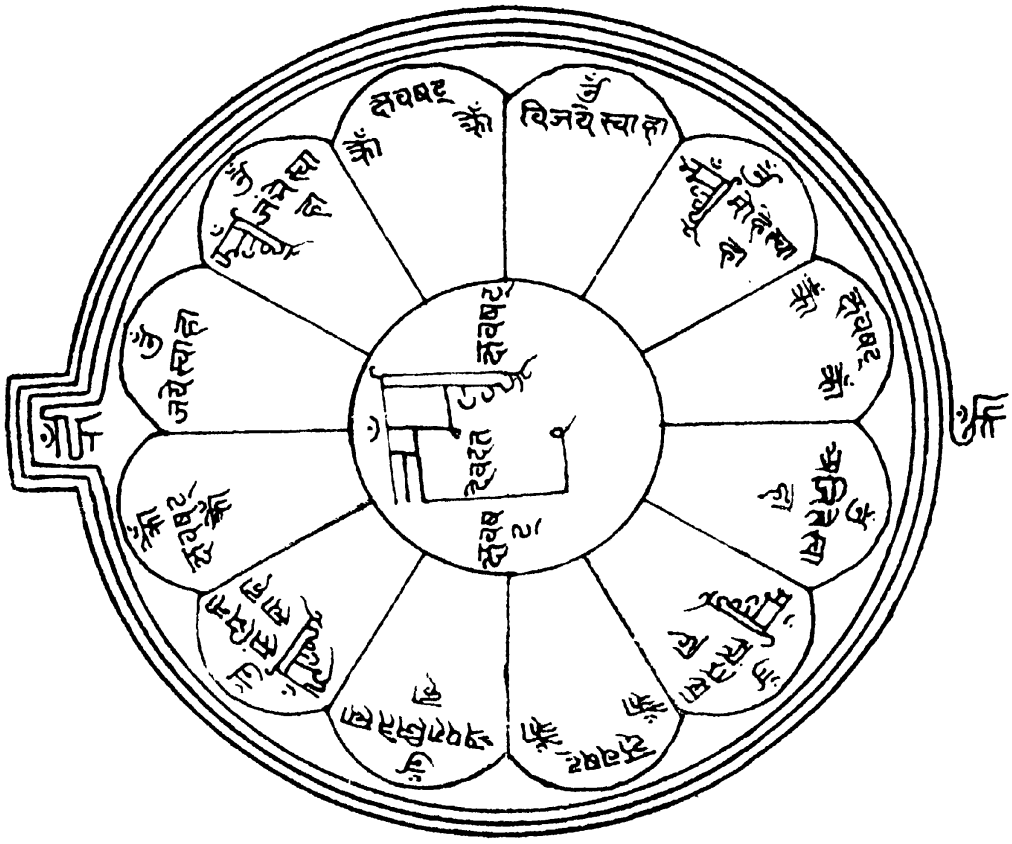

Fig. 14

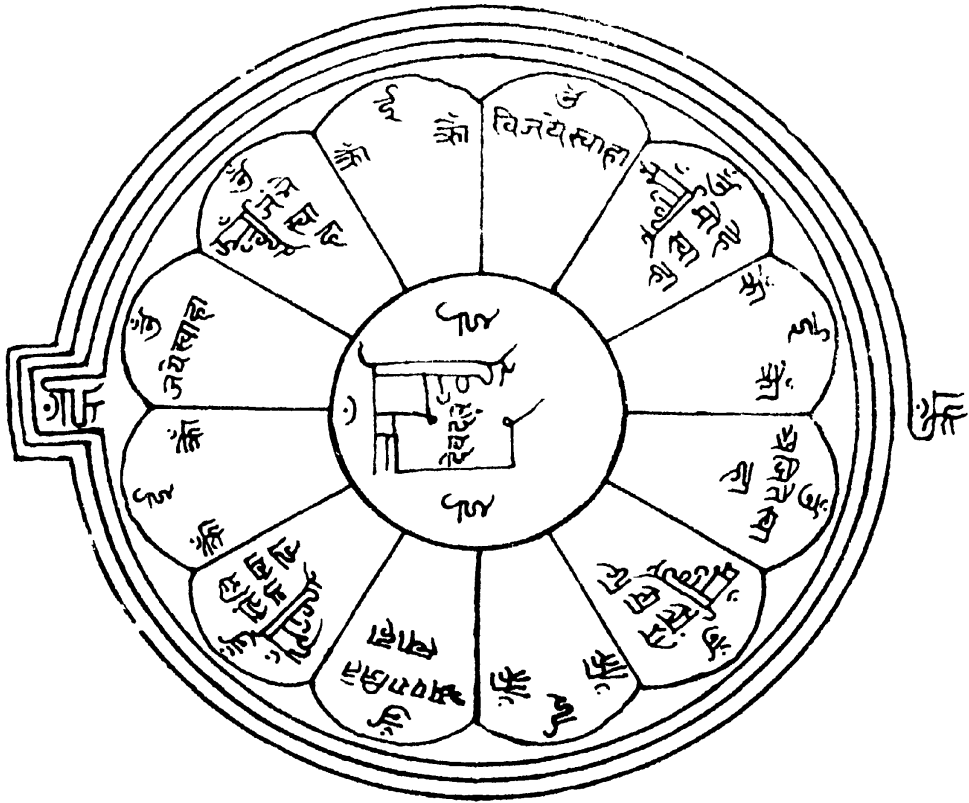

Fig. 13

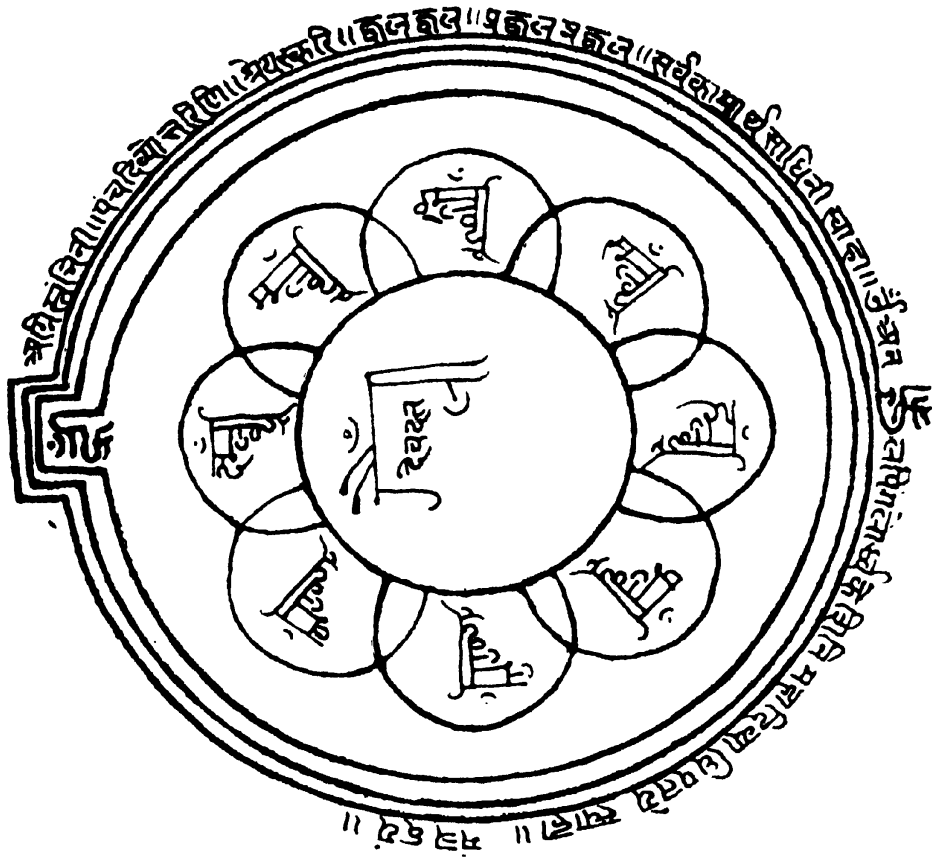

Fig. 16

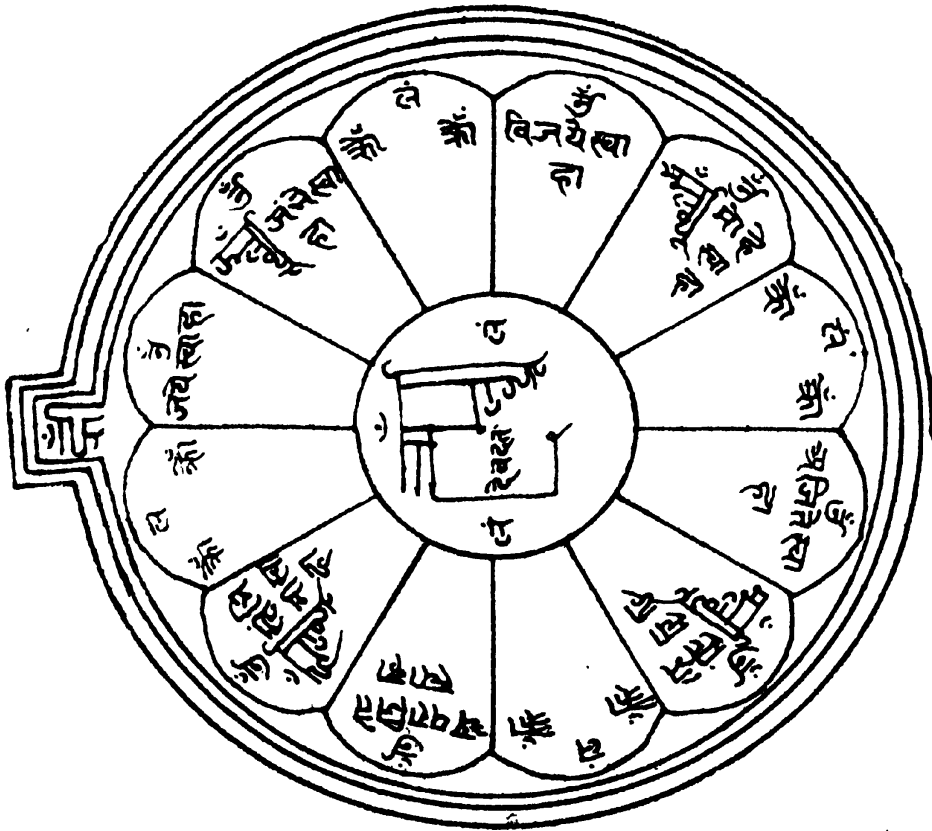

Fig. 15

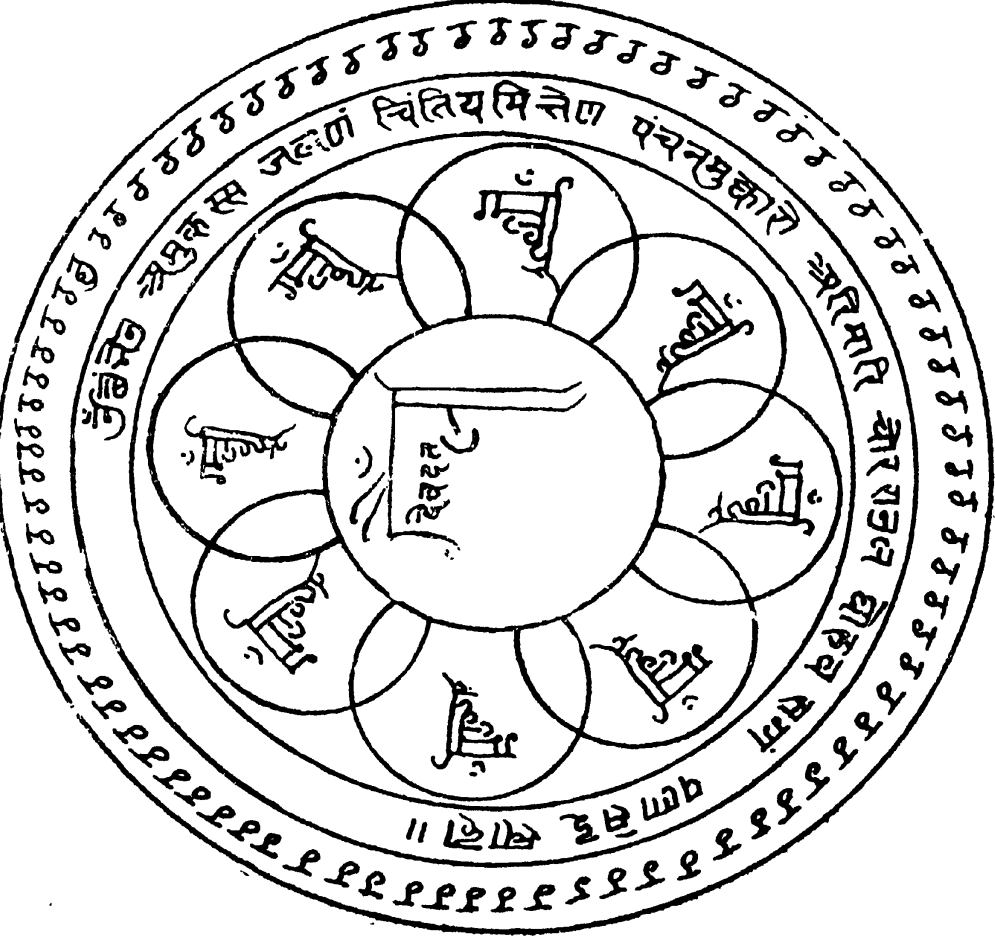

Fig. 17

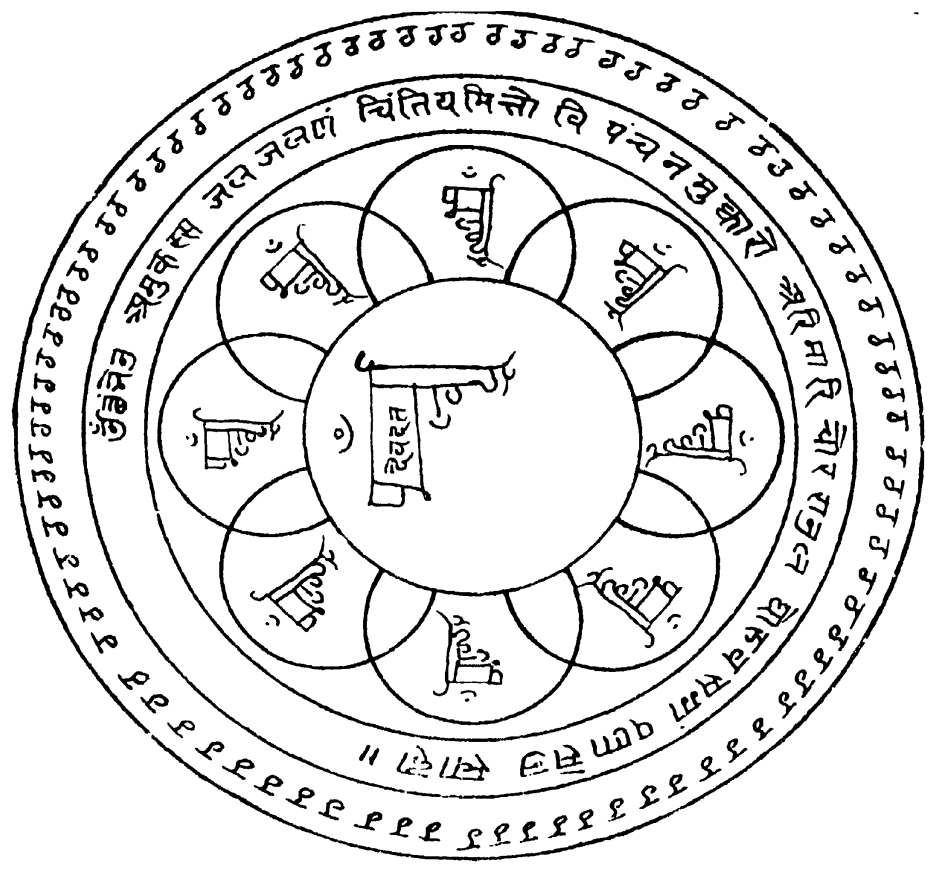

Fig. 18

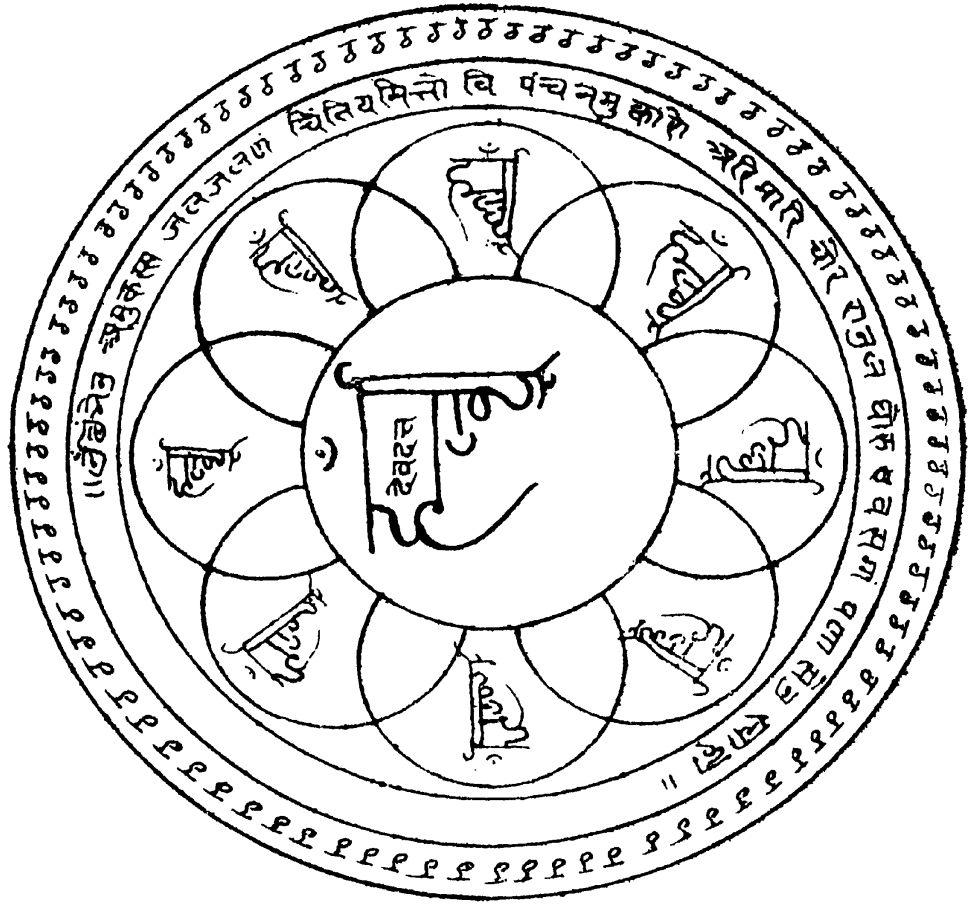

Fig. 20

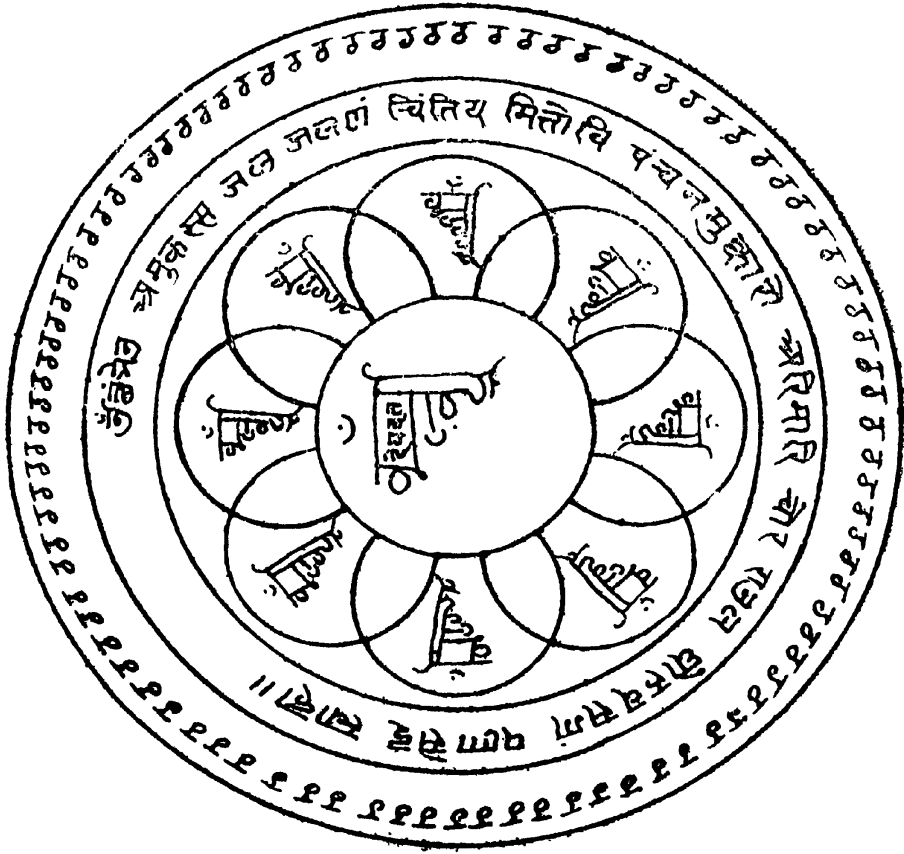

Fig. 19

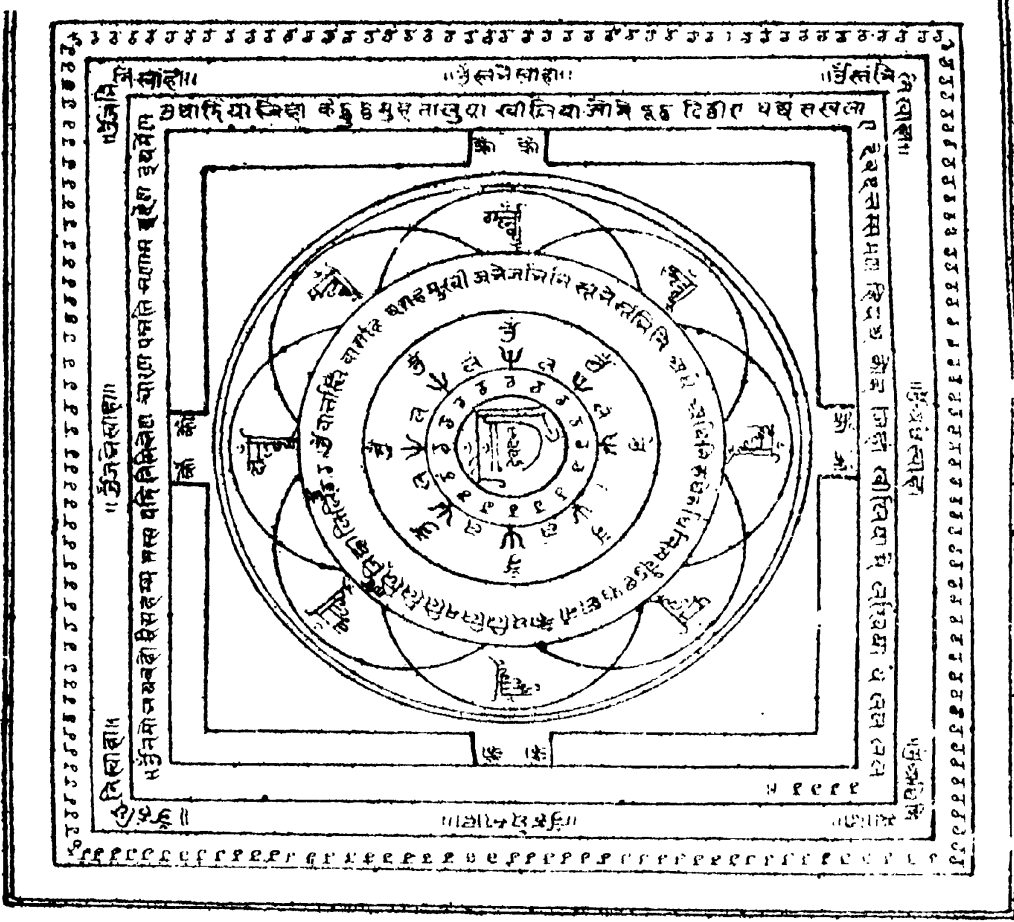

Fig. 22

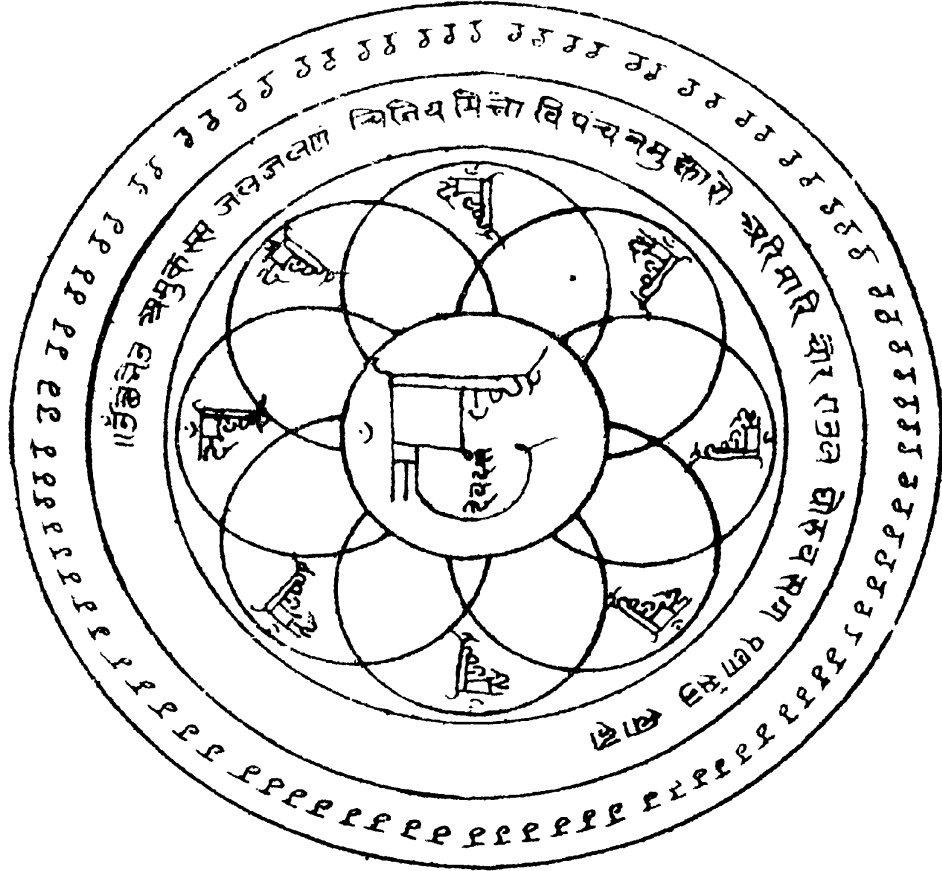

Fig. 21

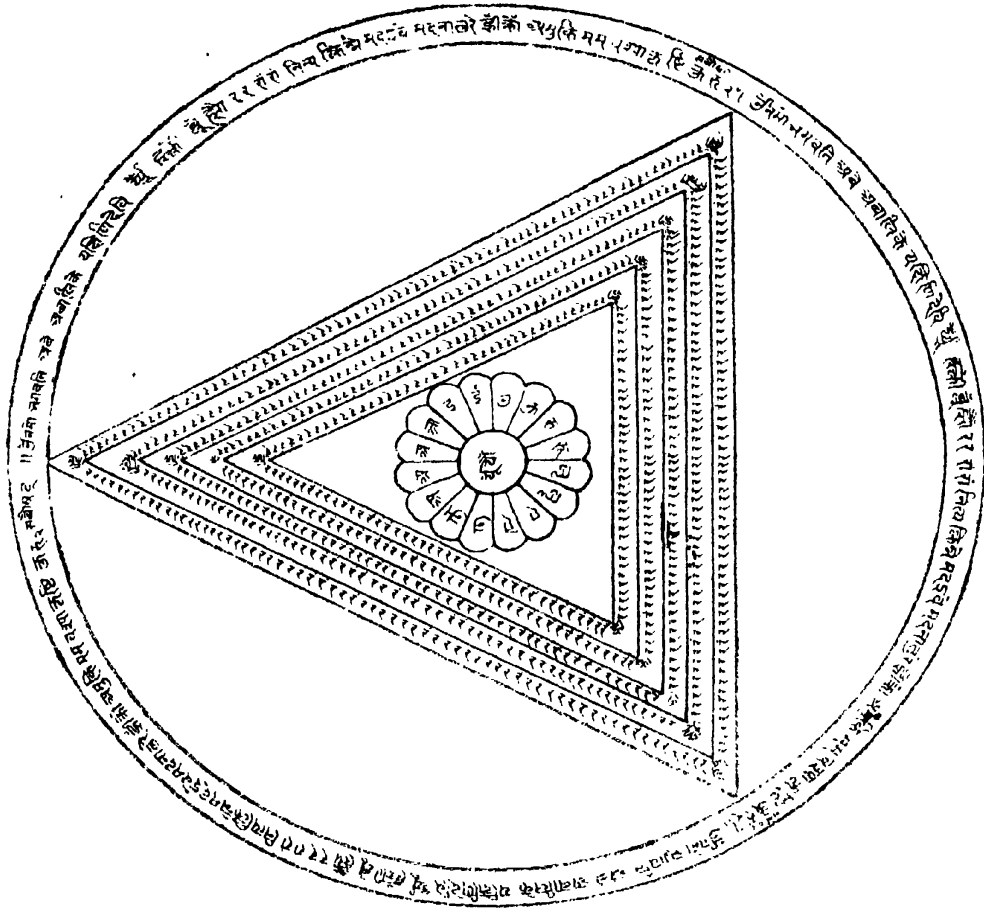

Fig. 24

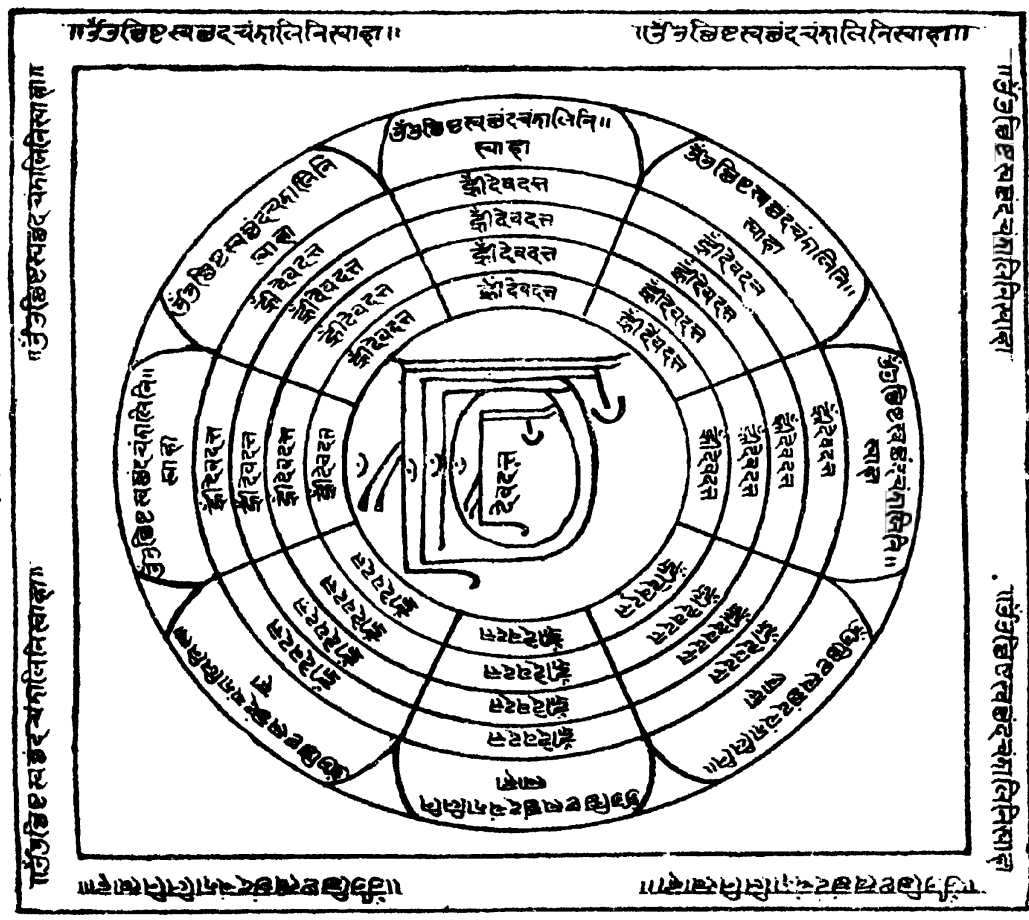

Fig. 23



Fig. 26

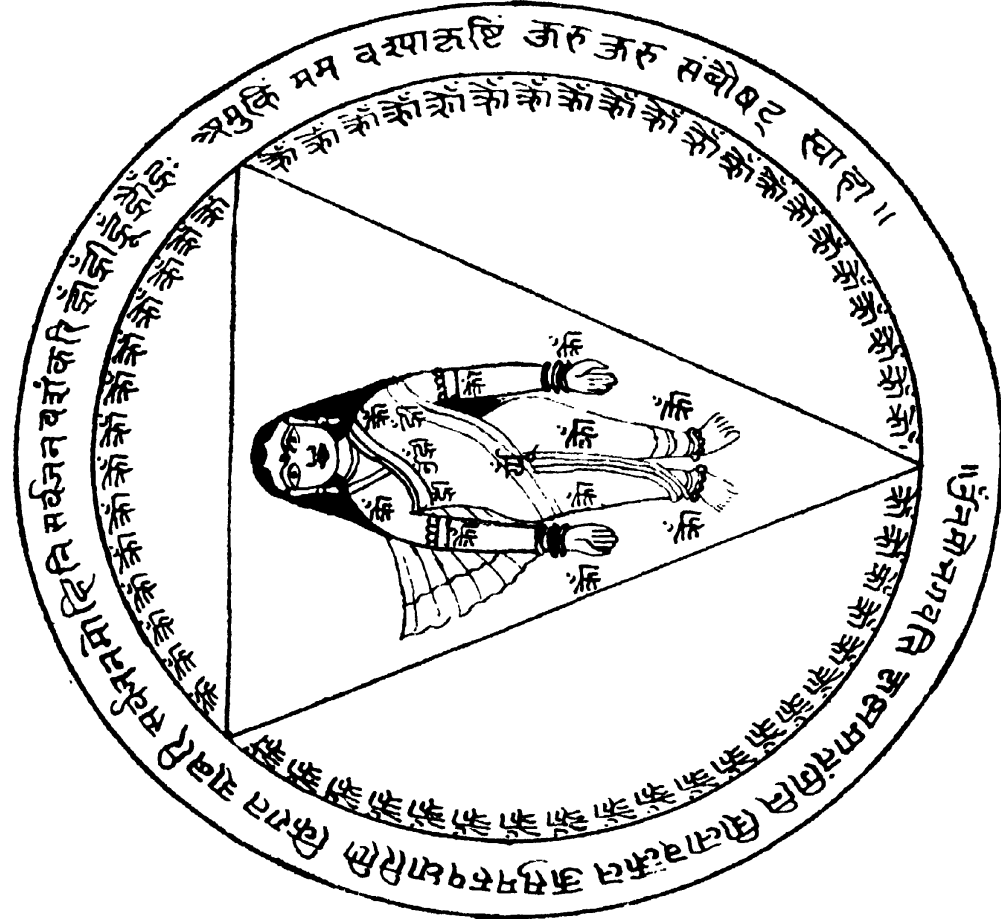

Fig. 25

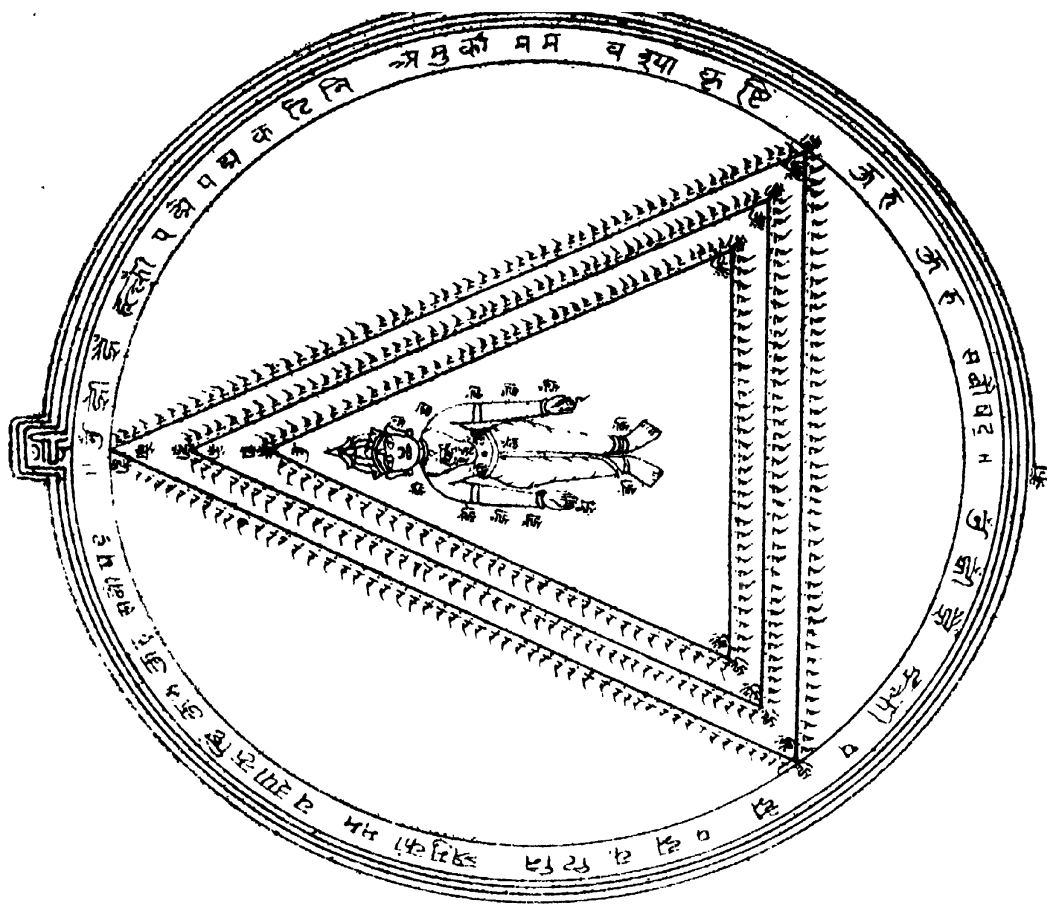

Fig. 28

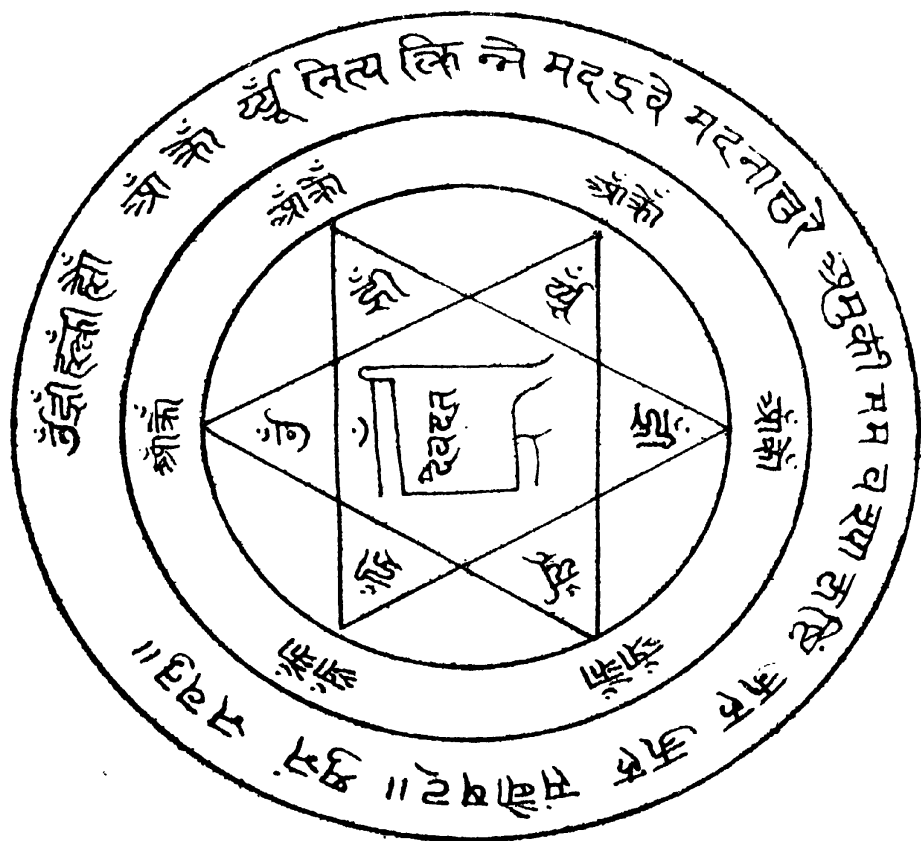

Fig. 27

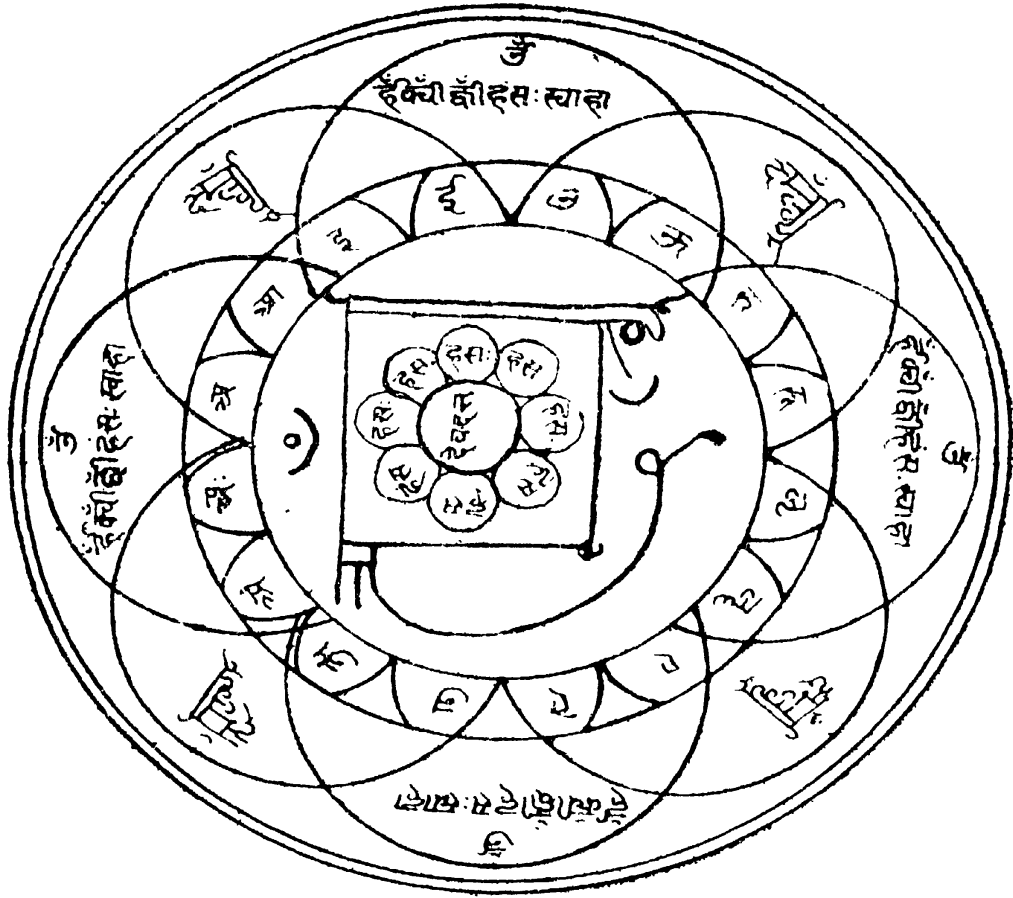

Fig. 30

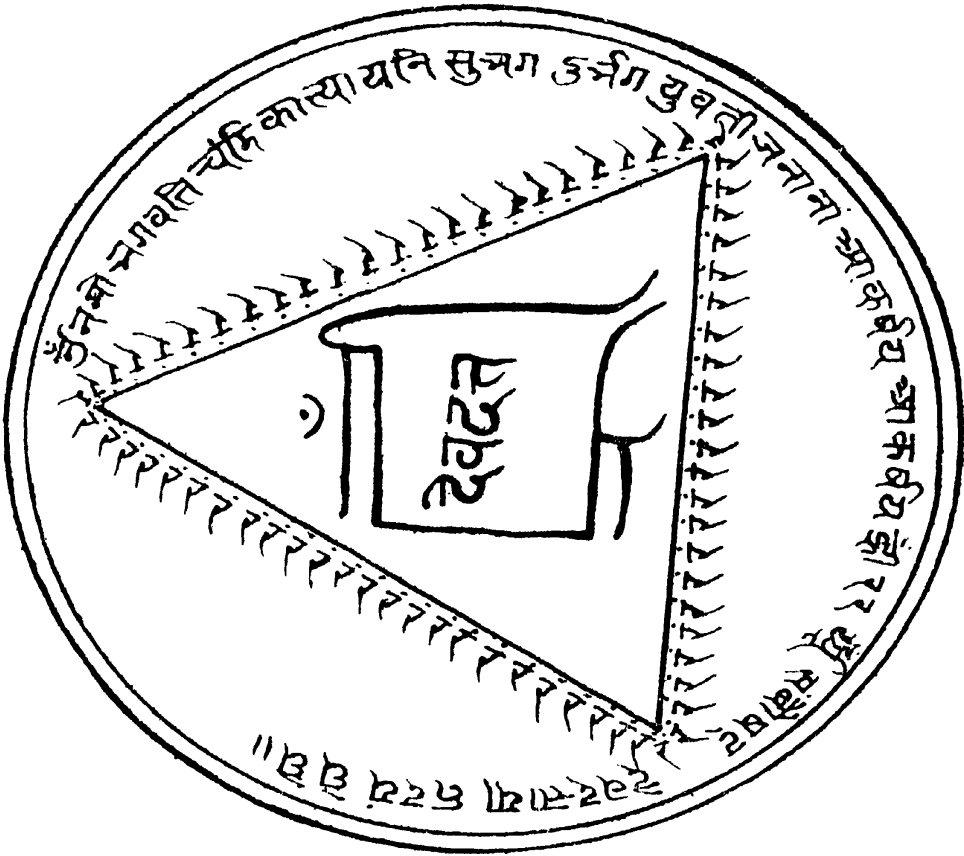

Fig. 29

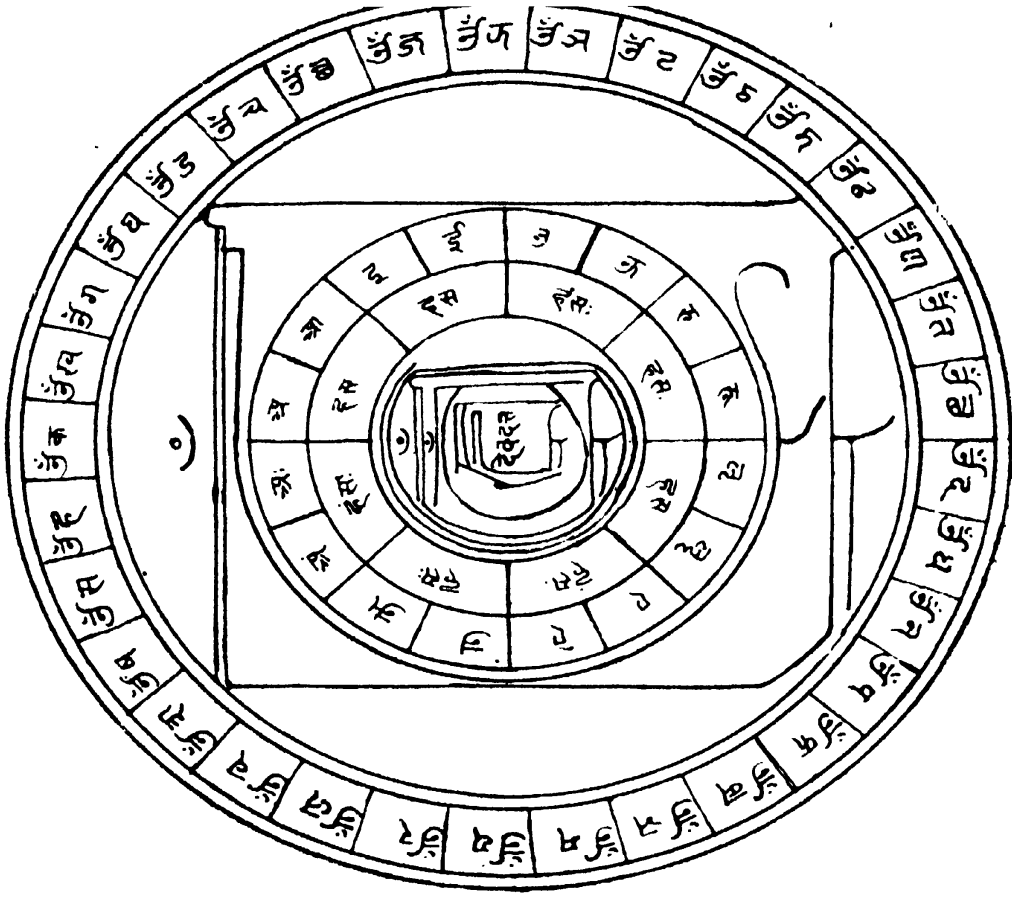

Fig. 32

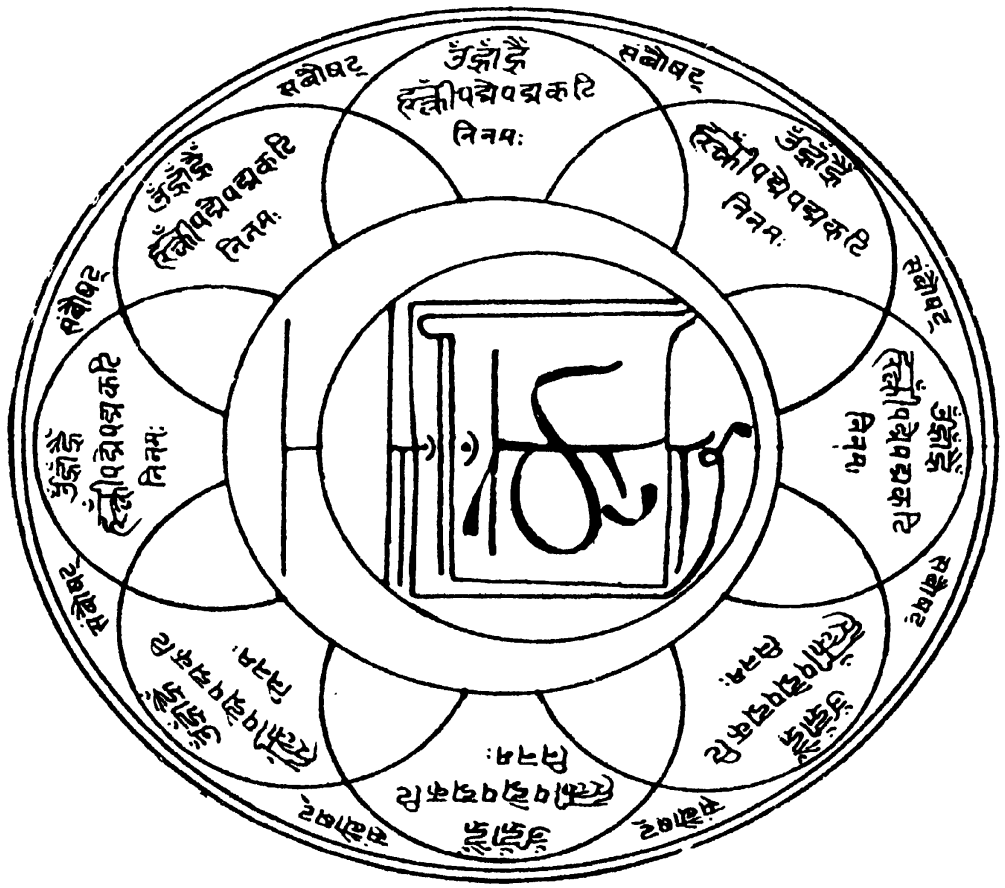

Fig. 31

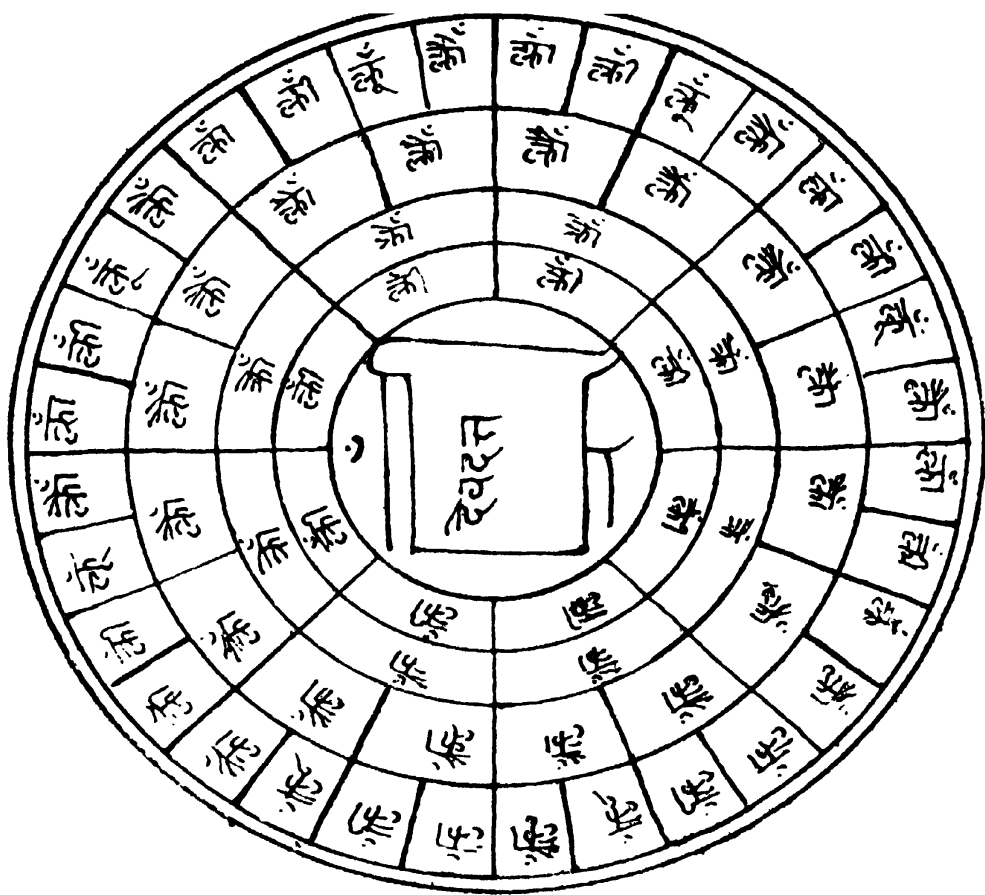

Fig. 34

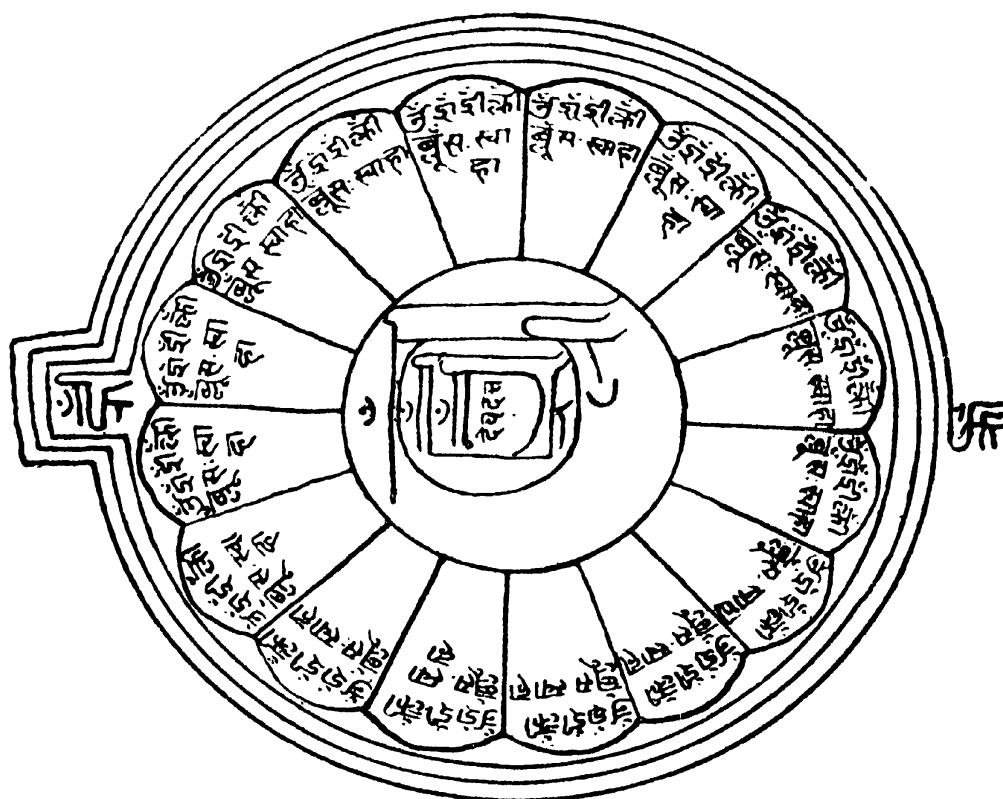

Fig. 33

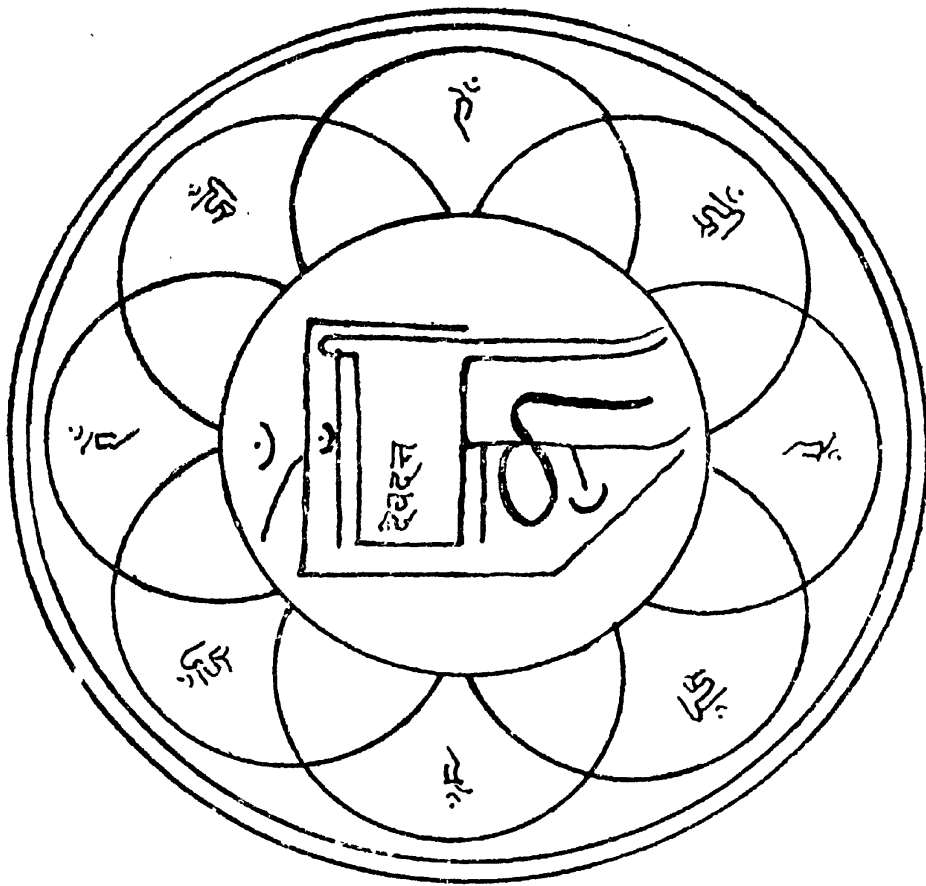

Fig. 36

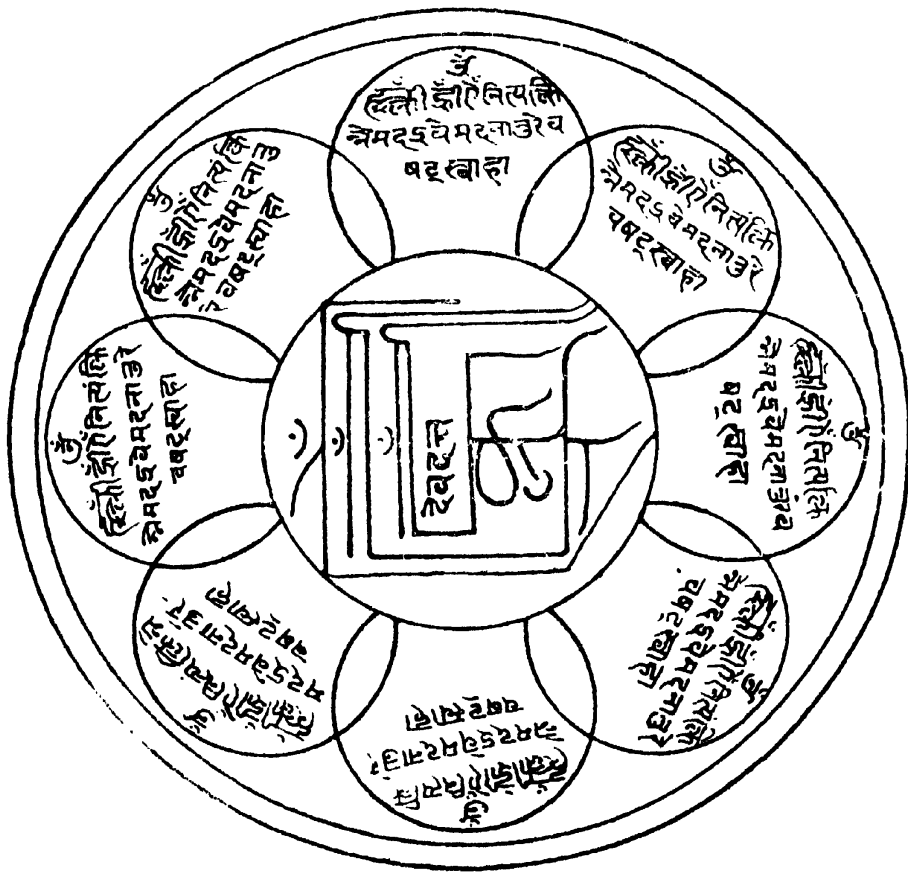

Fig. 35

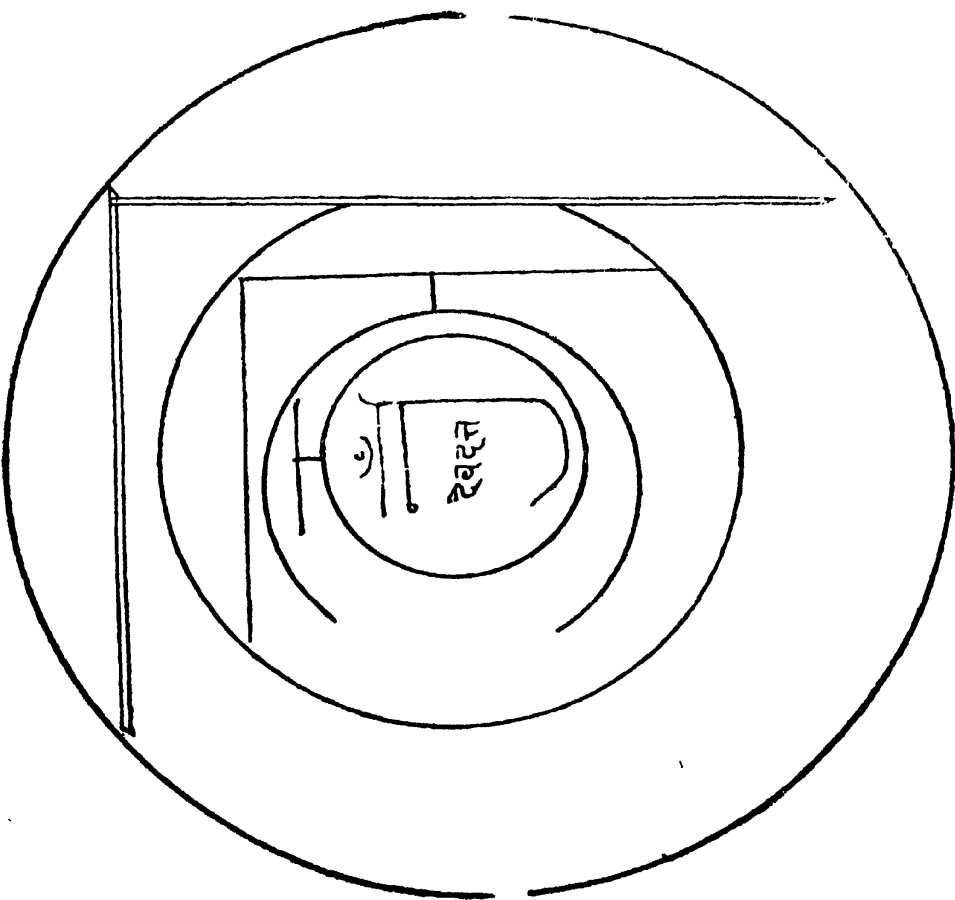

Fig. 37

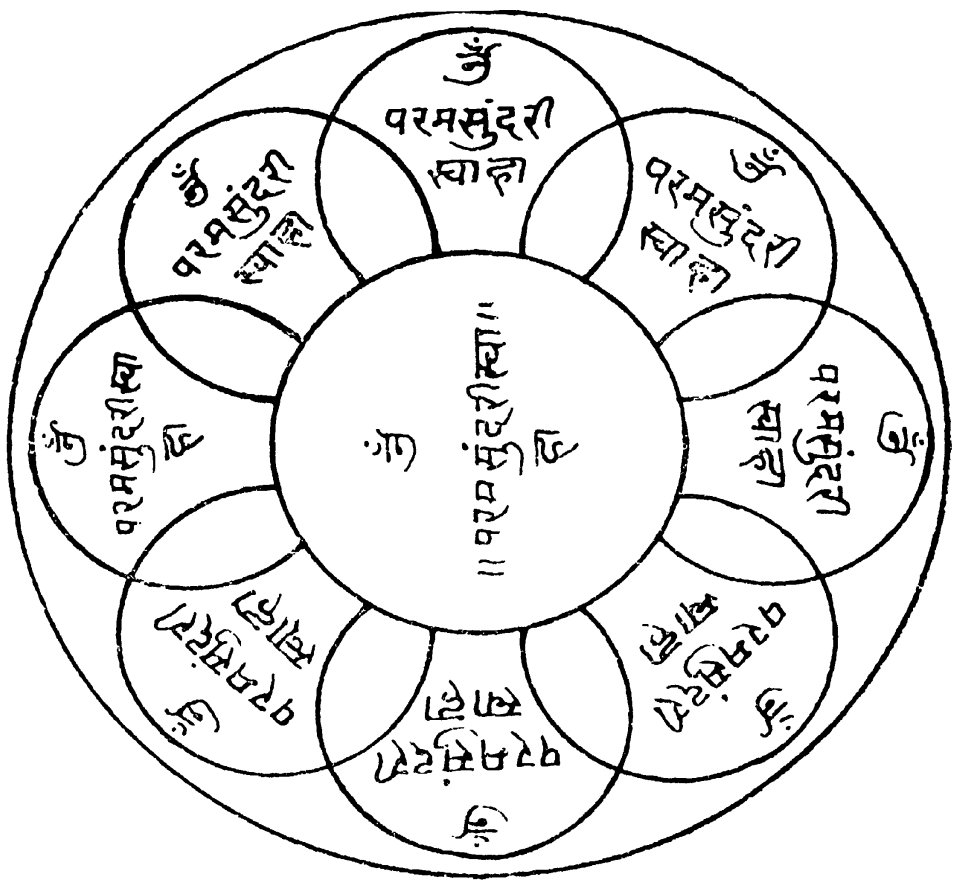

Fig. 38

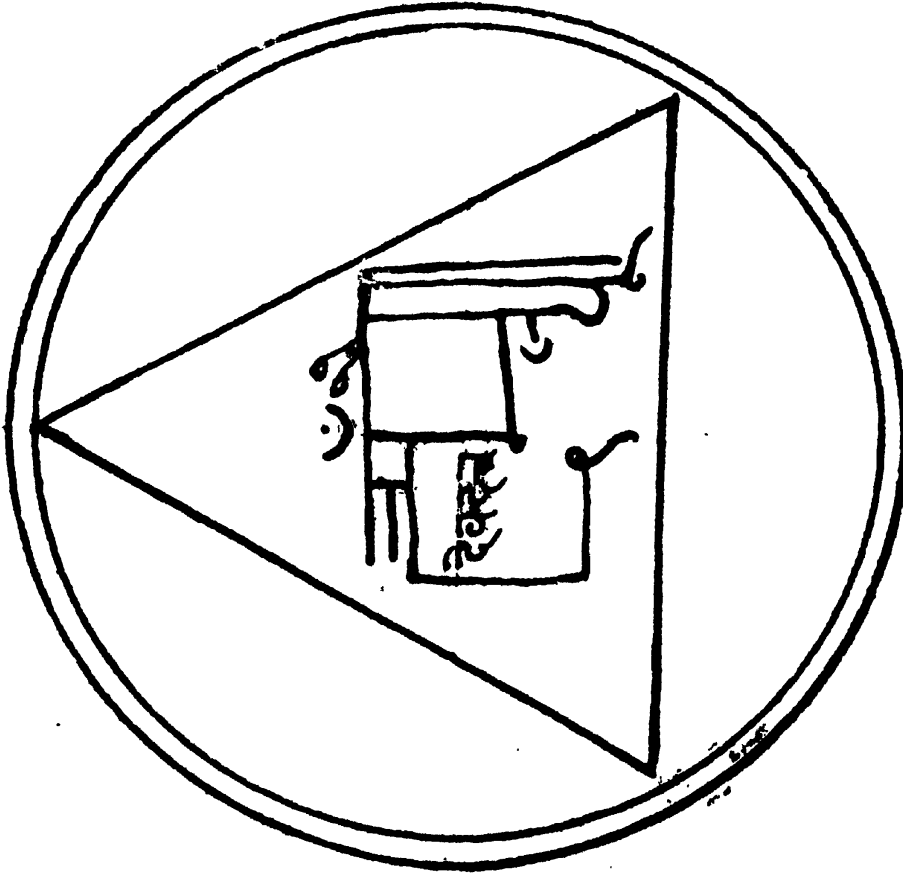

Fig. 39

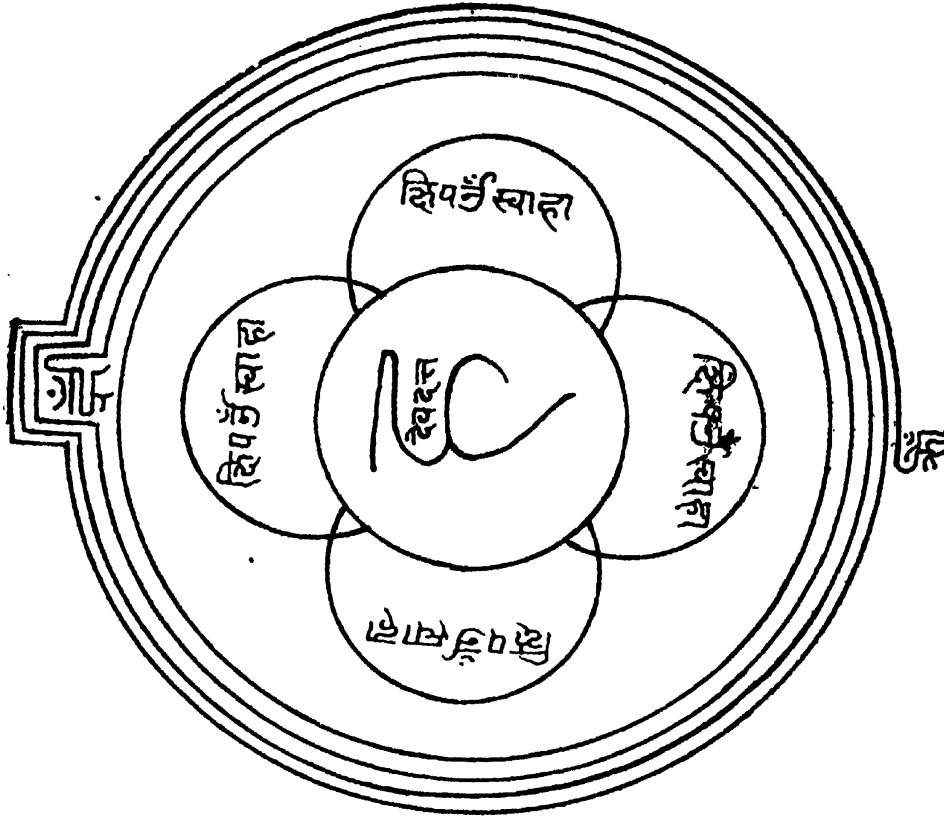

Fig. 40

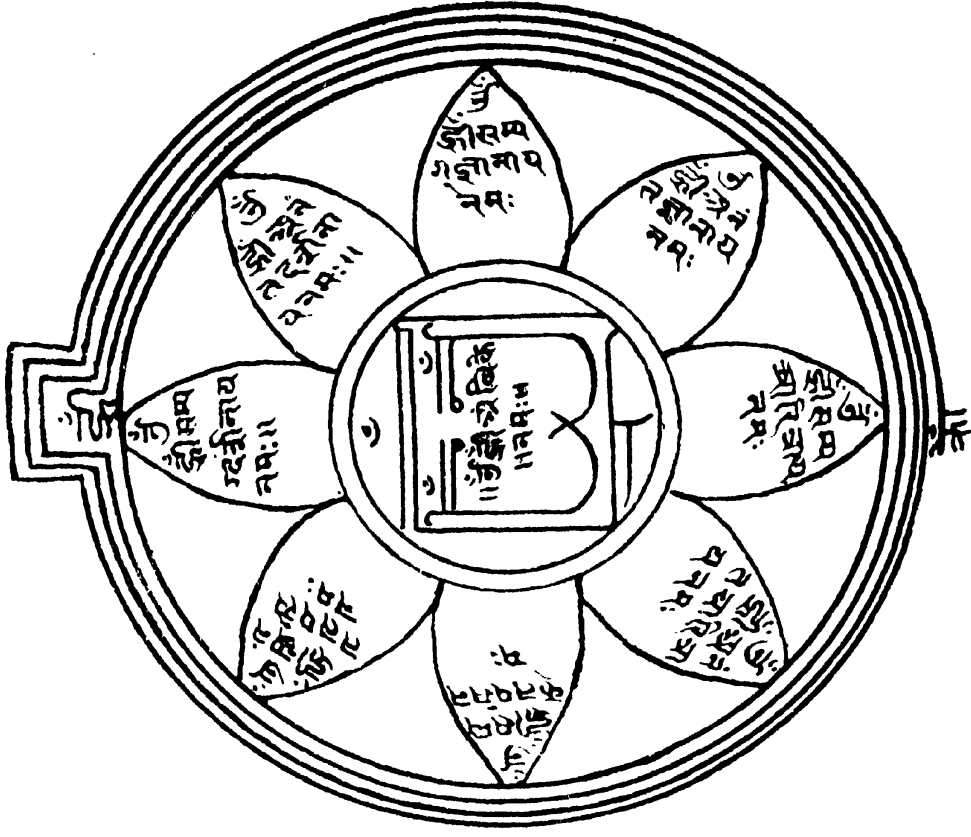

Fig. 42

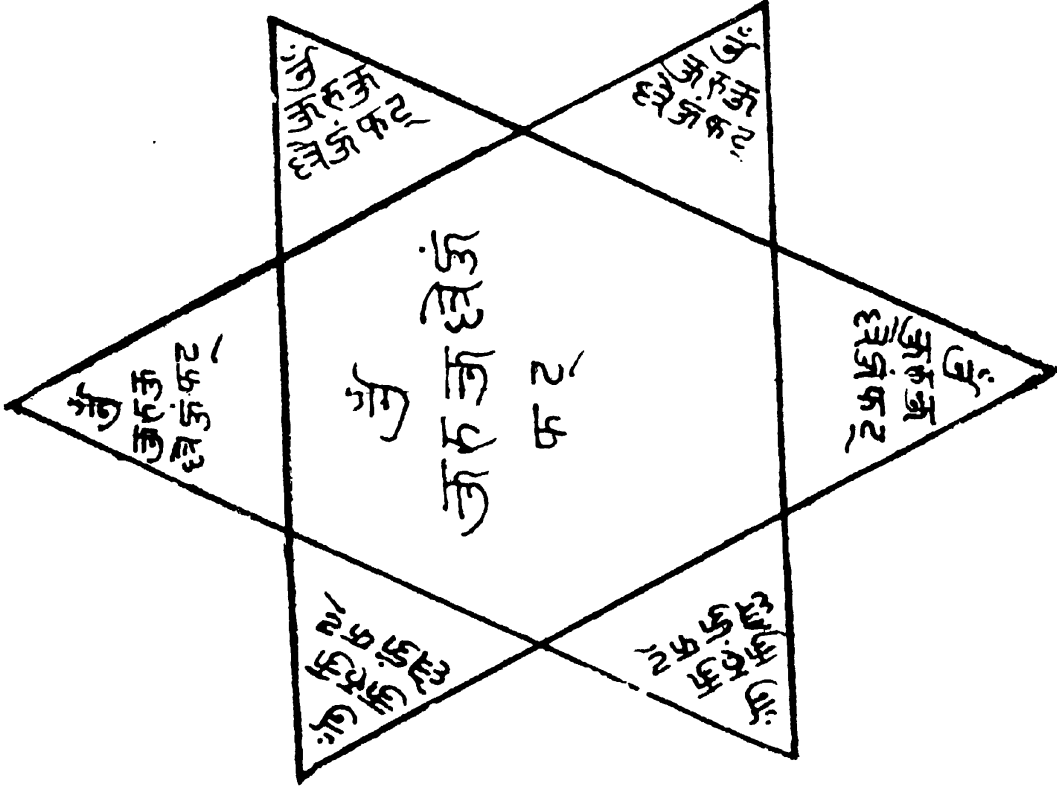

Fig. 41

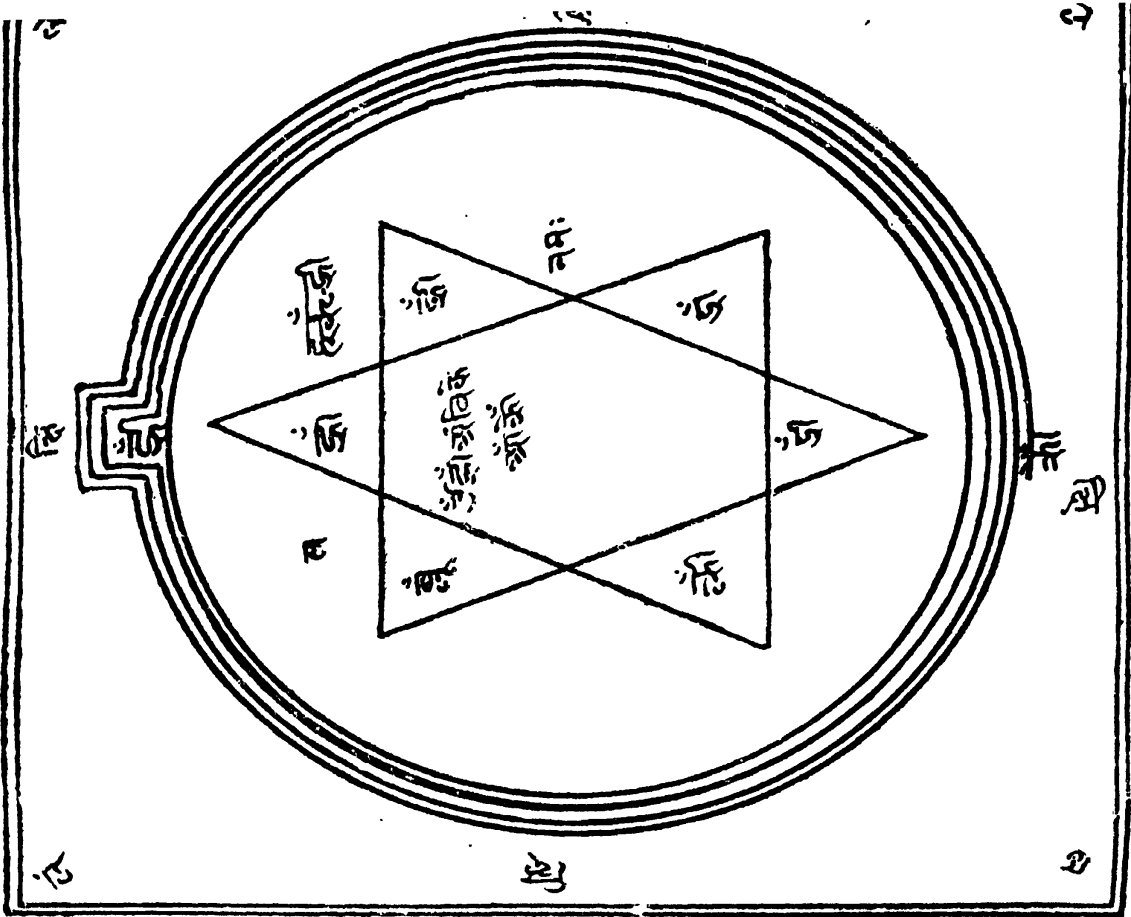

Fig. 44

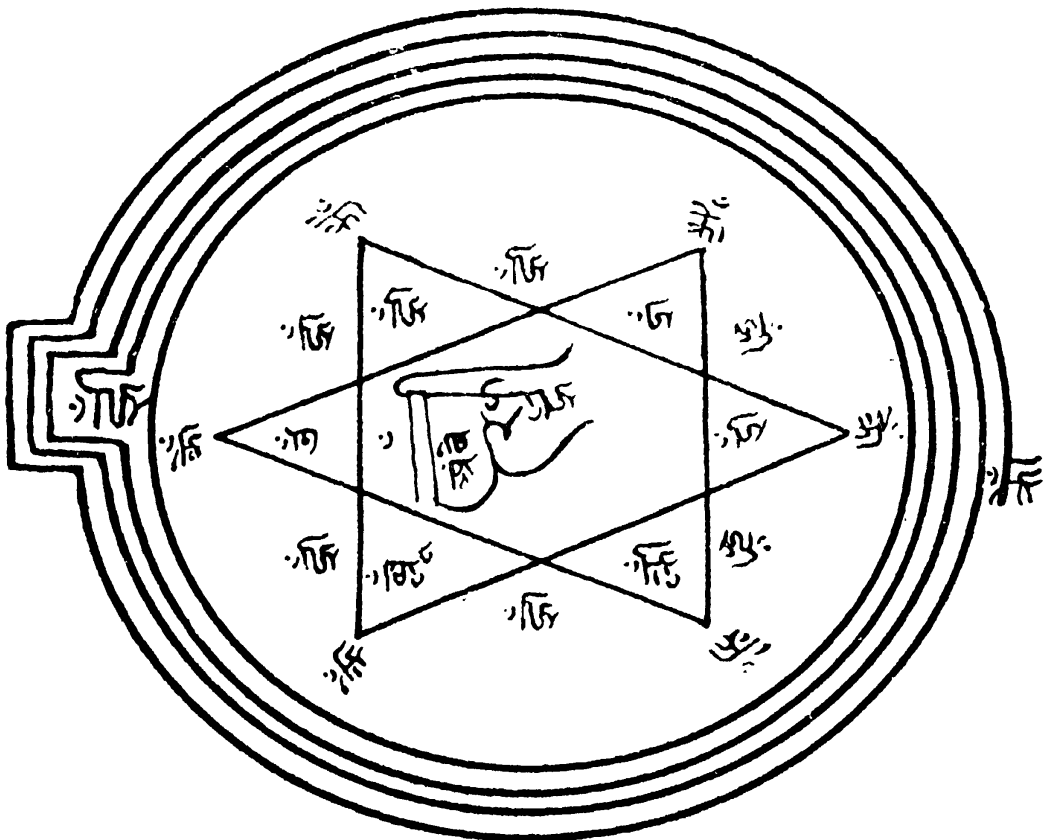
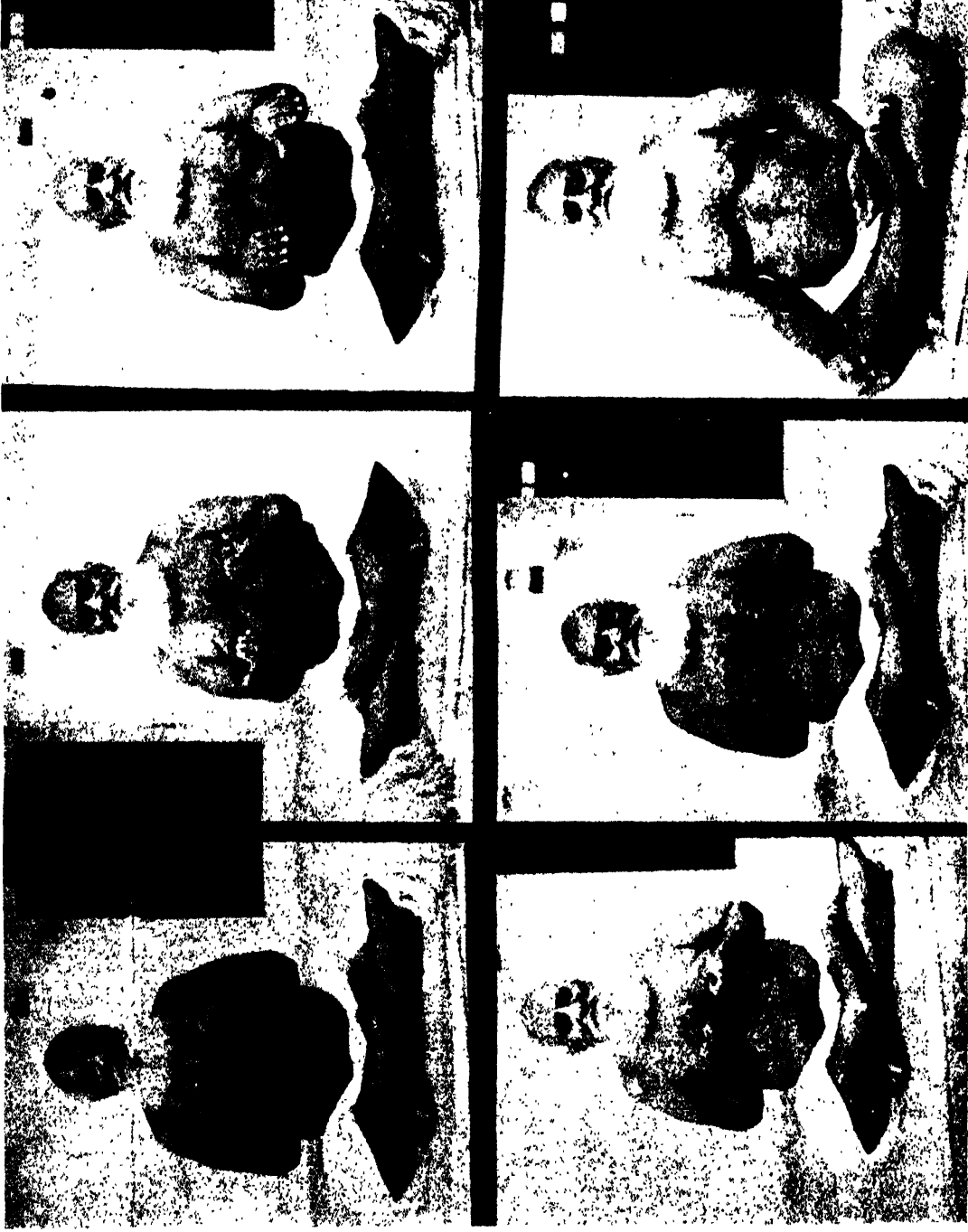

Fig. 43



Tantric Mudras
(तांत्रिक मुद्राओ)

Fig. 46 to 51



Fig. 52 to 57

Tantric Mudras
(तांत्रिक मुद्राओं)

